



# Instructions for 36" Wide Vacuum-Break Starters Rated 200 and 400 Amperes, 7200 Volts, Slide-Out Type



**DANGER**

## HAZARDOUS VOLTAGE.

**READ AND UNDERSTAND THIS BOOKLET IN ITS ENTIRETY BEFORE INSTALLING OR OPERATING CONTROLLER. INSTALLATION, ADJUSTMENT, REPAIR AND MAINTENANCE OF THESE CONTROLLERS MUST BE PERFORMED BY QUALIFIED PERSONNEL. A QUALIFIED PERSON IS ONE WHO IS FAMILIAR WITH THE CONSTRUCTION AND OPERATION OF THIS EQUIPMENT AND THE HAZARDS INVOLVED.**

## THE CONTROLLER

Each Ampgard® motor starter (controller) consists of one nonload-break isolating switch, one or more Type SLS vacuum-break contactors, current-limiting fuses, a set of current transformers, and some form of overload protection. The isolating switch has a limited make and break rating, suitable only for closing and opening limited magnetizing current loads. The controller is designed to start, stop and protect a three-phase medium-voltage motor within the ratings shown in Table I. The controller may also be used to switch transformer windings or other medium voltage loads. Each Ampgard® controller occupies all or a portion of a steel structure that may also enclose a horizontal bus system to distribute power to two or more sections and a vertical bus system in each section connected to the horizontal main bus system. The controllers are configured for full-voltage or reduced-voltage starting, reversing or nonreversing, single-speed or two-speed applications.



Fig. 1 Ampgard® Motor Controller, 36" Wide

**TABLE I: APPLICATION DATA**

System Voltage	2400V	3300V	4160V	6600V		
<b>SLS –200 amp</b>					<b>Arcing Time</b> 12 mS (0.75 Cycle) or Less <b>Pickup Voltage</b> 80% Rated Coil Voltage <b>Dropout Voltage</b> 60% Rated Coil Voltage <b>Control Voltages</b> Selectable: <b>AC</b> 110-120, 220-240 50/60Hz <b>DC</b> 125 <b>Control Circuit Burden</b> Closing (AC)/(DC) 600VA (200 Milliseconds) Holding (AC)/(DC) 30 VA <b>Auxiliary Contact Rating</b> Voltage (Max) 600 V Continuous Current 10 A Making Capacity (AC) 7200 VA (DC) 125 VA Breaking Capacity (AC) 720 VA (DC) 125 VA Min. Voltage/Current 5V/100mA <b>Latch (when Specified)</b> Mechanical Life 250,000 operations Trip Voltage (DC) 24 Volts (DC) 125 Volts (AC) 110/120 volts Min. Trip Voltage 80% Rated Coil Voltage Trip Burden (24 VDC) 100 VA (125 VDC) 200 VA (110 VAC & 120 VAC) 150 VA Trip time 30 M sec (2 cycles)	
Induction Motor	800 HP	1100 HP	1500 HP	2250 HP		
Synchronous Motor (0.8 PF)	800 HP	1100 HP	1500 HP	2250 HP		
Transformer	1000 HP	1250 HP	1750 HP	2750 HP		
	750 KVA	1000 KVA	1250 KVA	2000 KVA		
<b>SLS – 400 amp</b>						
Induction Motor	1750 HP	2250 HP	3000 HP	4500 HP		
Synchronous Motor (0.8 PF)	1750 HP	2250 HP	3000 HP	4500 HP		
Transformer	2000 HP	2500 HP	3500 HP	5500 HP		
	1500 KVA	2000 KVA	2500 KVA	4000 KVA		
<b>Max. Interrupting Current (3 OPS.)</b>	4500 Amps (SL-200)				<b>Mechanical Life</b>	2,500,000 Operations
<b>Rated Current</b>	8500 Amps (SL-400)				<b>Electrical Life</b>	300,000 Operations
	200 A Enclosed (SL-200)				<b>BIL</b>	60 kV (1.2 x 50 Microseconds)
	400 A Enclosed (SL-400)				<b>Dielectric Strength (60 Hz)</b>	20 kV (1 Minute)
<b>Max. Rated Voltage</b>	7.2kV				<b>Closing Time</b>	80 Milliseconds
<b>Making/Breaking Capacity</b>	4000 amps				<b>Opening Times</b>	30 to 250 Milliseconds
<b>Short Time Current</b>						Dip Switch Selectable
30 Sec.	2400 A					Refer to Table IV
1 Sec.	6000 A					
8.7 MS (0.5 Cycle)	63kA Peak					
	(I <sup>2</sup> t=5.89mega-joules)					

## THE CONTROLLER (Cont.)

While this instruction booklet is dedicated to full-voltage starting, the other applications listed are an expansion of the same principles shown.

### MEDIUM-VOLTAGE COMPONENTS

The flow of current through a vacuum-break controller (starter) can be traced by referring to the lower portion of Figure 4, where the controller is shown in the energized position. The line stab assembly mounted at the back of the enclosure also serves as the controller line terminals (1). The stabs themselves are engaged by the fuse jaws (2) of the isolating switch which is mounted on rails above the contactor. The ferrules (3) of the current-limiting motor-starting power circuit fuses (4) clip into the fuse jaws, and the load ferrules (5) fit into the fuse holders (6) which are part of the contactor line terminals. Current flows through the contactor from the load ferrules of the power circuit fuses, through the contactor line bus (7), and the vacuum interrupters (bottles) of the contactor (8), to the contactor load terminals (9). Cables pass through current transformers and connect the contactor load terminals to the controller load (motor) terminals mounted on the enclosure wall to the left of the isolating switch. See Figure 2.

### LOW-VOLTAGE CONTROL COMPONENTS

The low-voltage components consisting of an interposing relay, protective relays, and optional equipment are generally mounted on a slide-out panel. The single-phase control power transformer is bolted to the contactor frame. The capacity of this transformer ranges from 600 VA to 2 kVA, depending upon requirements. The primary winding of the control power transformer is connected to the line through the power circuit fuse assembly, and is protected by two additional low rating current-limiting fuses mounted on the contactor. See Figure 6. The secondary of the control power transformer supplies power to the 120 (or 240) volt grounded control circuit through a secondary fuse mounted next to the test-run plug.

The slide-out panel and attached door constitute the low-voltage compartment for most Ampgard motor controls. This panel and door combination may be removed from the base enclosure by first removing four machine screws from the top and bottom rail bayonets on the back side of the panel and lifting the panel up until the bayonets clear their slots. These screws must be replaced when the panel is reinstalled to maintain stability. Pull-apart terminal blocks permit mechanical and electrical separation from the contactor. See Figures 3 and 6.

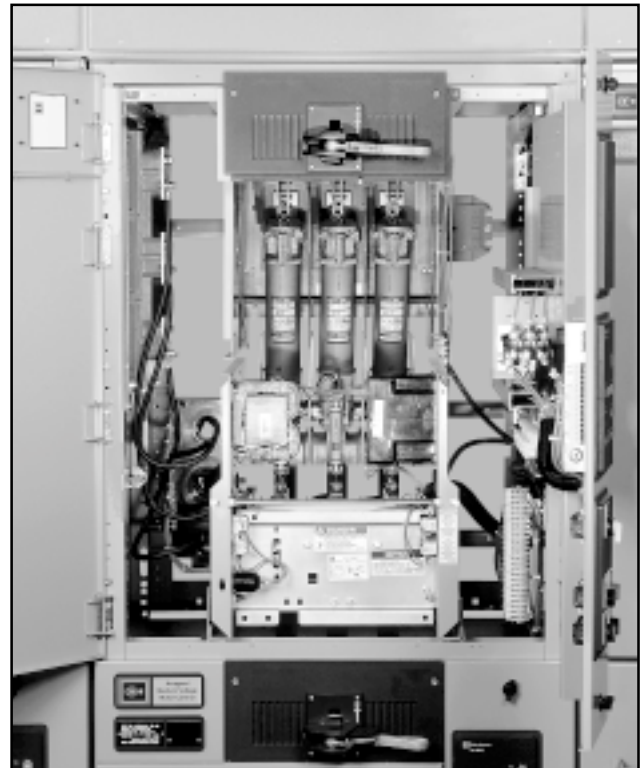

Fig. 2 SLS Contactor & Isolating Switch

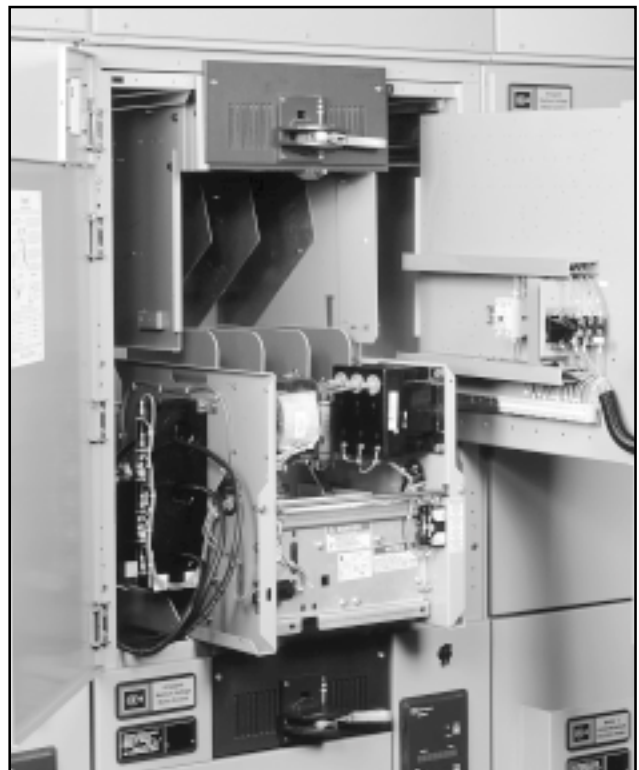

Fig. 3 Low-Voltage Compartment

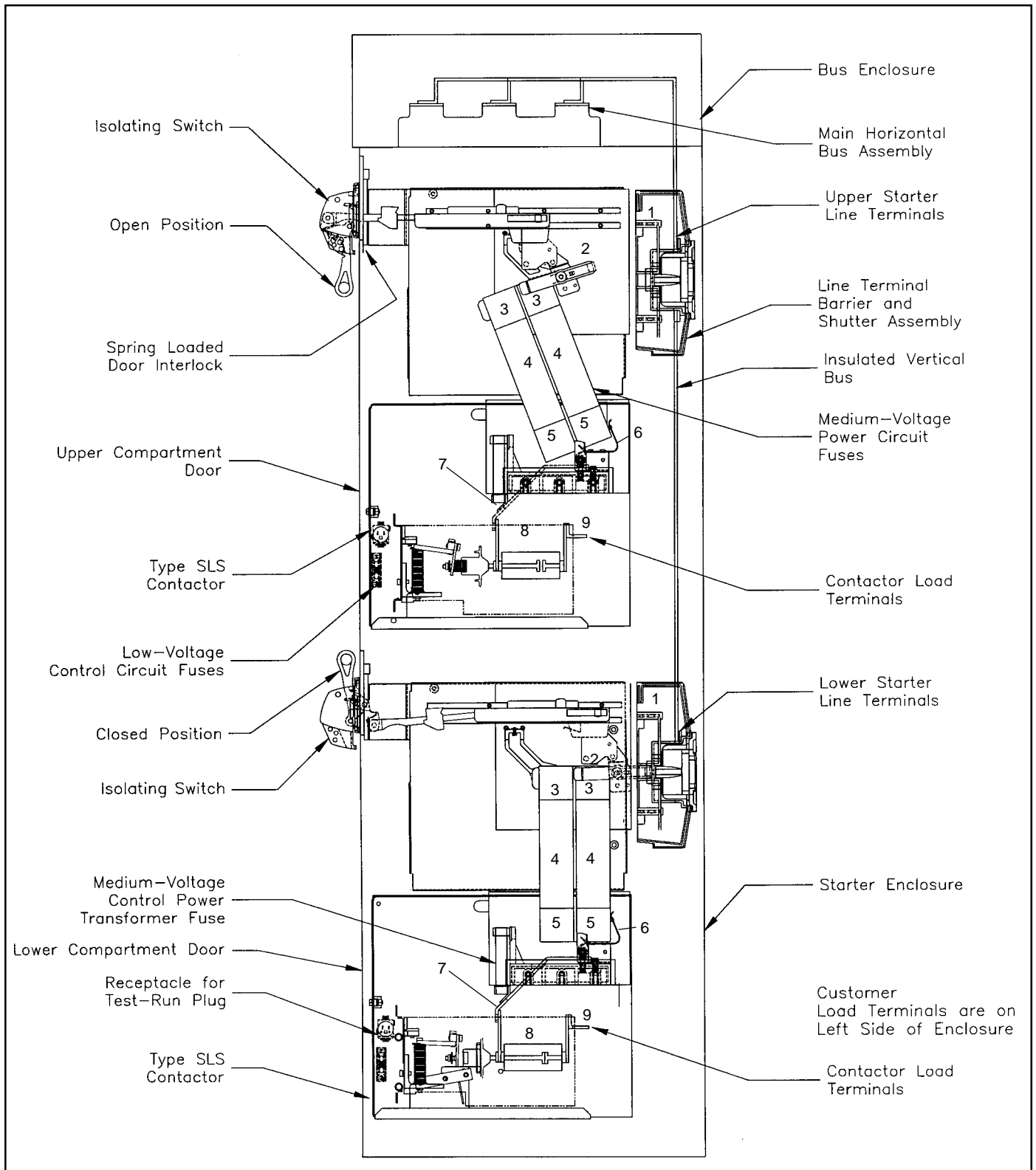

Fig. 4 Ampgard® Components, Two Starters (Controllers) Shown

### LOW-VOLTAGE CONTROL COMPONENTS (Cont.)

To energize the primary of the control power transformer, the contactor must be inserted into the enclosure, the power circuit fuses must be installed, and the isolating switch must be closed.

For convenience during maintenance, when it may be desirable to energize the contactor or the control circuit, a test-run plug is provided. WITH THE ISOLATING SWITCH OPEN, disconnect the plug from the socket and plug it into a 120 volt single-phase polarized extension cord (or 240 volt when specified). See Figure 6.

Disconnect this temporary circuit and restore the plug to its socket on the contactor before returning the unit to service.

### LOW-VOLTAGE CUTOFF SWITCH

Two auxiliary switches are installed behind the operating handle housing of the isolating switch and used to disconnect the load of a control power transformer, space heaters, or other auxiliary circuits. Each of these auxiliary switches has an inductive load rating of 20 amperes at not greater than 250 VAC. These auxiliary contacts operate within the first five degrees of movement of the isolating switch handle. At least one of the normally-open contacts of these switches disconnects the control power transformer from its load.

### ISOLATING SWITCH

Each Ampgard® isolating switch is a medium-voltage, three-pole, manually operated device. It consists of an operating mechanism and a sliding tray mounted between two steel end plates. The sliding tray is molded insulating material and carries three sets of fuse jaw finger assemblies. One end of the fuse jaw finger assembly grips the upper ferrule of the power fuse while the other end engages the line stab. In the switch open position, the three fuse jaw fingers are grounded.

Arc resistant and flame retarding insulating barriers are mounted between phases and also between the two outside poles and the isolating switch end plates.

This isolating switch is a nonload-break device. It must never close or interrupt a power load. However, it does have a limited capacity for interrupting the single-phase control power and potential transformers exciting current. In terms of transformer ratings, the maximum load is the equivalent of an unloaded (exciting current only) 6 kVA transformer.

An Ampgard® starter is shipped with the isolating switch in the ON position (Figure 5, View A). The isolating switch handle is operated by moving it through a vertical arc from the ON to the OFF position. From the OFF position, it can be rotated 90° counterclockwise to the HORIZONTAL position, the door-open position (Figure 5, View D).

In both the ON and OFF positions, a portion of the handle housing extends over the door to the medium-voltage compartment, preventing this door from being opened.

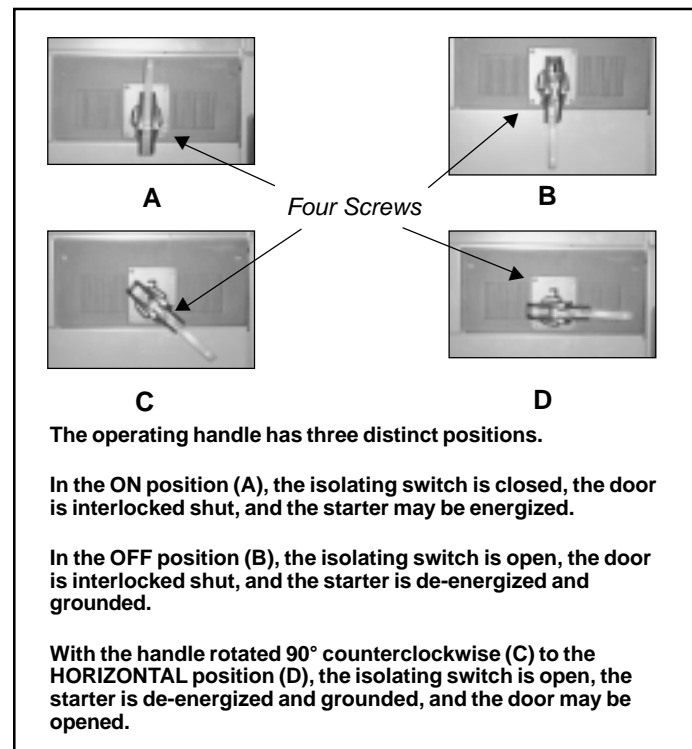

Fig. 5 Isolating Switch Handle Positions

To open this door, the handle must be moved to the HORIZONTAL position.

With the handle in the OFF position, up to three padlocks can be used to lock out the switch, preventing the handle from being moved to either the ON or the HORIZONTAL position. This locked position prevents both unauthorized entry into the medium-voltage compartment and accidental closing of the isolating switch while maintenance work is being done. From the HORIZONTAL position, the handle cannot be moved to the ON position without first moving to the OFF position.

### FUSE SELECTION AND COORDINATION

Fuse selection is dependent on motor locked rotor current, acceleration time, and full load current. To prevent fuse fatigue it is recommended that the minimum melting time of the fuse always exceed the locked rotor current times a safety factor of 1.25 at the motor acceleration time. The motor full load current must always be less than the fuse continuous current rating. Cutler-Hammer selects fuse ratings based on the following assumptions: 1) Locked Rotor Current is equal to 6 times Full Load Current, and 2) Acceleration time is 10 seconds at full voltage.

During high-power testing the SL-400 contactor was confirmed to properly coordinate with Cutler-Hammer Type CLS current limiting motor starting fuses. Tests were conducted with 5.08kV-24R and 7.2kV-24R fuses. The contactor successfully withstood the let-through energy of

each fuse for a 50kA available symmetrical fault at the rated voltage of the fuse. Maximum let-through occurred with the 5.08kV fuse. The maximum observed current was a 63kA peak, with  $I^2t$  equal to 5.89 mega-joules. The SL-200 contactor will coordinate with Cutler-Hammer Type CLS fuses rated 5.08kV-12R and 7.2kV-12R.

Proper coordination must be maintained between the contactor interrupting rating, contactor dropout time, and the total clearing time of the main fuse. Care must be exercised when selecting the dropout time setting on the contactor control board. The contactor must not open on a fault greater than it's rated interrupting current. By holding the contactor closed for the appropriate time, the fuse will clear if the fault current exceeds the contactor rating. Delays in relays settings should not be included in the calculation since it is likely that the voltage will collapse and allow the contactor to drop open no matter what the setting of the relay. The standard factory dropout setting is 130 ms (8 cycles). Table II lists the minimum recommended dropout times for coordination with the available ratings for main power fuses supplied with Ampgard starters.

For more information, refer to Cutler-Hammer Application Data 36-693 which includes minimum-melt, total clearing, and let-through curves for Type CLS motor fuses.

**ENCLOSURE**

These Ampgard® motor controllers are supplied in cells assembled into floor-mounted enclosures. These enclosures are 36 inches wide x 30 inches deep x 90-inches high (92 cm wide, 76 cm deep, and 229 cm high). Each 90-inch high enclosure accommodates one or two Ampgard® starters depending upon the requirements. Complex controllers such as reduced-voltage starting require more than one 36" wide section. A 10-inch (25cm) high horizontal bus enclosure can be added at the top which increases the total enclosure height to 100 inches (254 cm).

**MECHANICAL INTERLOCKS**

Before putting an Ampgard® controller into service, become familiar with the mechanical interlocks.

**Door Interlock**

With the isolating switch handle in the HORIZONTAL position, the door to the medium-voltage compartment can be opened. As soon as the door opens, a mechanical interlock becomes effective. It is designed to prevent the user from accidentally operating the isolating switch handle and closing the starter on to the line with the door open.

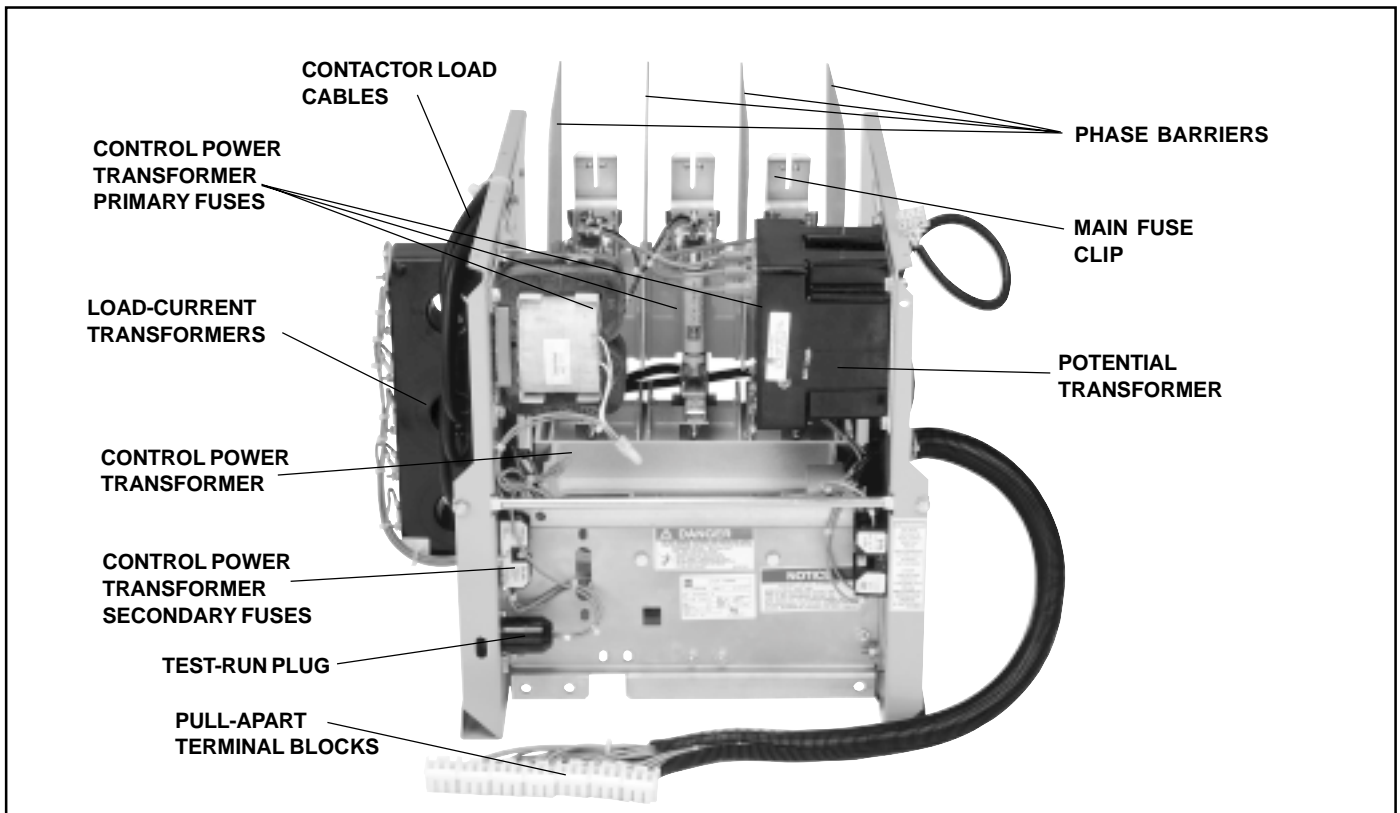

Fig. 6 Type SLS Contactor, Front View

TABLE II. FUSE APPLICATION TABLE FOR SL-200 AND SL-400 CONTACTORS

**SL-200**

Motor FLA Voltage		Fuse	Rating	Min Opening Time
11.0-18	2400-4800V	449D597G01	30-1R	30
18-31		449D597G02	70-2R	30
31-46		449D597G03	100-3R	30
46-62		449D597G04	130-4R	30
62-74		449D597G05	150-5R	30
74-93		449D597G06	170-6R	30
93-137		151D933G01	200-9R	130
137-187		151D933G02	230-12R	130
187-200*		151D933G02	230-12R	130 * For FLA > 187, Max Accel Time = 3.5 seconds
11.0-34	5500-6900	151D963G01	70-2R	30
34-46		151D963G02	100-3R	30
46-56		151D963G03	130-4R	30
56-68		151D963G04	150-5R	30
68-85		151D963G05	170-6R	30
85-137		151D963G06	200-9R	60
137-200		151D963G07	230-12R	250

**SL-400**

Motor FLA Voltage		Fuse	Rating	Min Opening Time
11.0-18	2400-4800V	449D597G01	30-1R	30
18-31		449D597G02	70-2R	30
31-46		449D597G03	100-3R	30
46-62		449D597G04	130-4R	30
62-74		449D597G05	150-5R	30
74-93		449D597G06	170-6R	30
93-137		151D933G01	200-9R	30
137-187		151D933G02	230-12R	30
187-244		151D933G03	390-18R	60
244-360		151D933G04	450-24R	130
360-400**		151D933G04	450-24R	130 ** For FLA > 360, Max Accel Time = 6 seconds
11.0-34	5500-6900	151D963G01	70-2R	30
34-46		151D963G02	100-3R	30
46-56		151D963G03	130-4R	30
56-68		151D963G04	150-5R	30
68-85		151D963G05	170-6R	30
85-137		151D963G06	200-9R	30
137-187		151D963G07	230-12R	30
187-273		151D963G10	390-18R	60
273-400		151D963G11	450-24R	250

Note: Fuse selections based on LRC = FLA x 6, acceleration time of 10 seconds except where noted.

This interlock is a spring-loaded plunger located just below the handle housing. This prevents the handle from being accidentally returned to the OFF position. This interlock may be deliberately bypassed by depressing the plunger with a screwdriver so that the handle can be moved to the OFF position to observe the operation of the isolating switch during installation or maintenance. To do this, it is necessary to deliberately bypass the interlock. The handle must be returned to the HORIZONTAL position by again depressing the interlock plunger before the door can be closed. The operator must be aware of what he is doing and take appropriate safety precautions.

#### Contactor-to-Isolation-Switch Interlock

Mechanical interlocks between the contactor and isolation switch prevent the switch from being operated with the contactor closed. They also prevent the contactor from being closed if the switch is not either in the fully open or fully closed position.

Figure 8 shows the interlocks with the switch closed and the contactor open. Either the switch or the contactor may be operated. Figure 7 shows the interlocks with the contactor closed. The contactor interlock cam is rotated to prevent the rear of the lever from moving down. If the lever cannot move down, interlocks inside the isolation switch prevent the switch from operating. The lever is weighted so that if it is not properly attached to the connecting rod it will rotate and block the contactor from operation. Make sure that the connecting rod is connected to the lever.

The interlocks are factory set and sealed. Field adjustment should not be required. If during testing the interlocks are found to be out of adjustment, consult Cutler-Hammer for repair.

#### Line Stab Insulating Shutter

When an Ampgard® isolating switch is installed, both a shutter and a rear line stab barrier are in place in the controller structure and are intended to prevent accidental access to the line bus. As the isolating switch is opened, the sliding tray mechanically drives the insulating shutter closed across the three line stab openings in the rear barrier. As the shutter closes the openings, green and white striped labels are uncovered to visually indicate that the shutter is closed. With the isolating switch in the fully open position, the fuse jaw finger assemblies and the line side of the main fuses are connected to the ground bar.

As a final precaution before touching any of the electrical parts of the starter, visually check to make certain that the shutter is closed, the green and white striped labels are visible, the grounding fingers are in contact with the ground bar, and the tips of the fuse fingers are visible.

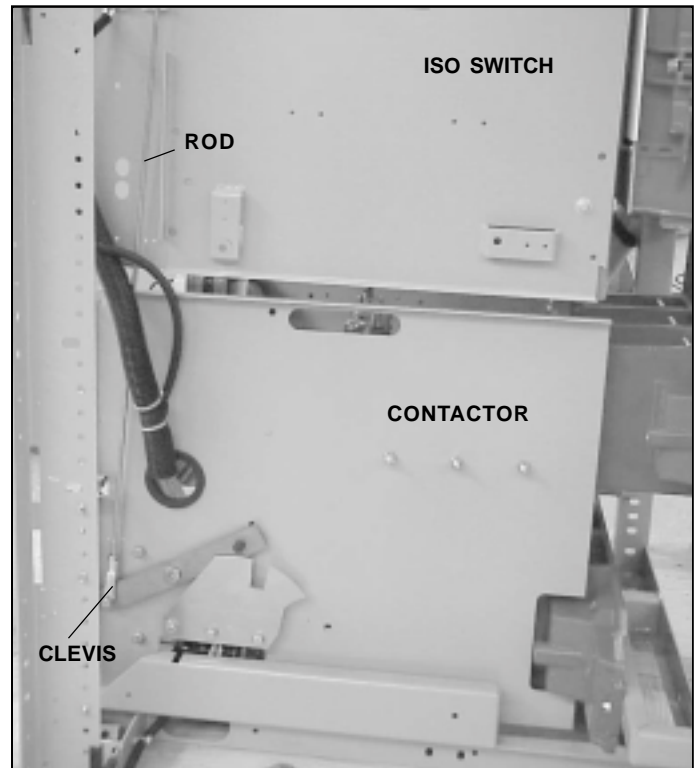

Fig. 7 Contactor Closed, Switch Operation Blocked



Fig. 8 Contactor Open, Interlock Neutral

When the isolating switch is removed from the starter structure, a latch lever (32, Figure 10) on the shutter assembly is activated. It is designed to hold the insulating shutter closed. This latch may be deliberately bypassed and the shutter moved to the open position. **CAUTION! Under these conditions the exposed line terminal stabs of the starter may be energized at line potential.**

When the isolating switch is replaced in the structure, the latch member is automatically released to allow the shutter to operate normally.

**THE CONTACTOR**  
**Magnetically Held Contactor**

The SLS contactor consists of a base SL contactor mounted between steel sidesheets with fuse mounting provisions, mechanical interlocks, and other components to form an integrated contactor truck assembly. The base contactor is mounted in the horizontal position between the sidesheets. Refer to Figure 6 for details.



**CAUTION**

**DUE TO ELECTRICAL CLEARANCE REQUIREMENTS, THE FOUR PHASE BARRIERS SUPPLIED WITH THE CONTACTOR MUST BE INSTALLED BEFORE THE CONTACTOR IS ENERGIZED. WHERE NO POWER FUSES ARE MOUNTED ON THE TOP OF THE CONTACTOR, AS IN THE CASE OF A REDUCED VOLTAGE CONTACTOR, NO BARRIERS ARE REQUIRED.**

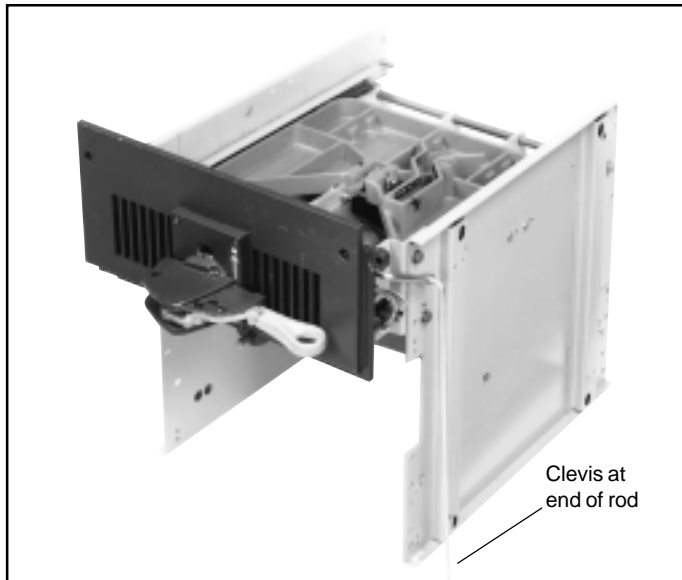

Fig. 9 Sliding Tray Mechanism of 400 Ampere Isolating Switch

A return spring located behind the moving armature plate (Figure 11) holds the contactor in the open position with the main coils deenergized.

The contactor is closed by energizing the contactor control board with the appropriate control voltage at terminals 1 and 2. The control board rectifies the input voltage and applies a pulse width modulated DC output voltage to the coils. The output voltage is approximately full voltage for the first 200 milliseconds after energization during which time the contactor closes and seals. The output voltage is then automatically reduced to approximately 15 VDC to maintain the contactor in the closed position.

The coil cores are magnetized which rotates the armature shaft, moving armature, and operating plate. As the operating plate moves toward the coil cores, the main contacts close. The plate continues to move an additional distance (known as overtravel) which allows for contact preload and wear (Figure 12).

When control power is removed from the control board the SL is held closed for a preset time and then opens. The range of time between the removal of control power and contact opening is from 30 to 250 milliseconds. The time can be adjusted for such factors as fuse coordination and voltage loss ride-through. Unless otherwise specified, the factory default setting is 130 milliseconds, or approximately 8 line cycles (60Hz). Refer to section on **Fuse Selection and Coordination** for more information on selecting the correct dropout time.

As the moving armature is rotated to the open position by the return spring, it impacts the stop assembly located at the front of the contactor (Figure 11). The stop assembly absorbs much of the kinetic energy of the moving armature and reduces the over-travel of the vacuum interrupters as the contactor is forced open.

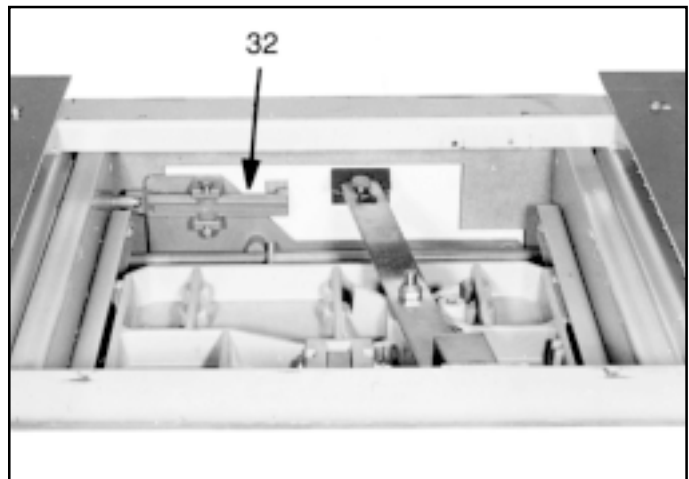

Fig. 10 Shutter Operating Mechanism



A selectable dipswitch is located on the control board for setting the control voltage level and the contactor dropout time (Figure 13). The control board must be removed from its cavity in the contactor housing to gain access to the dipswitch (Figure 14). Table III lists the available voltage settings and Table IV lists the available dropout settings.

**Mechanically Latched Contactor**

The mechanically latched contactor is closed in the same manner as the magnetically held contactor. After the contactor is electrically closed, a mechanical latch is engaged that holds the moving armature plate in the closed position. Power should then be removed from the control board by a N.C. auxiliary contact.

To open the contactor, the unlatch coil is energized with the appropriate control voltage. The coil engages a release lever on the latch mechanism. The contactor is then forced opened by the return spring.

**Auxiliary Contacts**

An operating lever attached to the rotating shaft operates a set of auxiliary contacts located on the bottom right of the contactor. The standard configuration is 2NO-2NC contacts. The auxiliary contacts are rated 600VAC, 10 amps continuous. Minimum ratings are 5 volts, 100 milliamps.

**Grounding**

A contactor ground pad is attached to the left front sidesheet of all main contactors. The CPT, CT, PT and control circuit are all connected to this pad. A ground wire connects the pad to the enclosure ground bus. See Figure 15.

Before initial startup and after any procedure where the contactor has been removed from the starter cell, insure that the ground wire is properly connected to both the contactor ground pad and the ground bus.

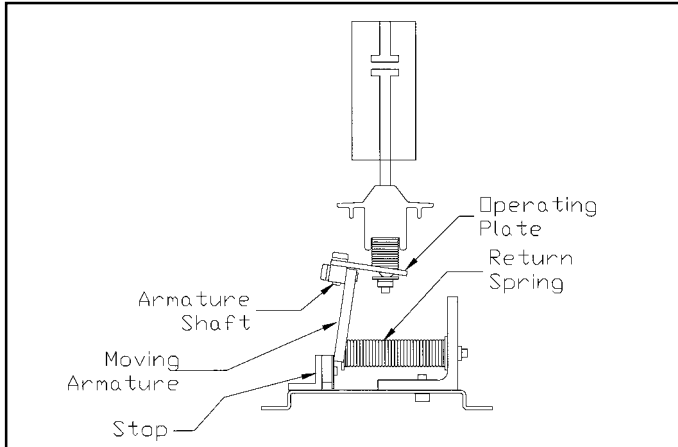

Fig. 11 Contactor Open

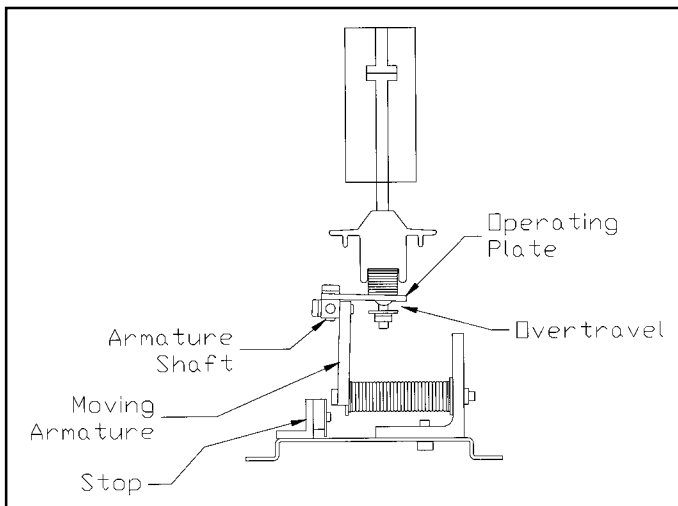

Fig. 12 Contactor Closed

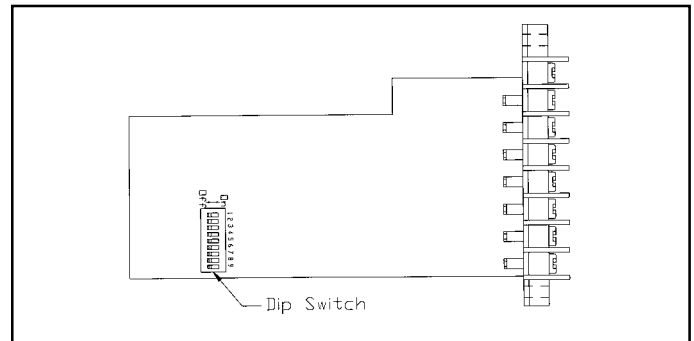

Fig. 13 Coil Control Board with Dipswitch

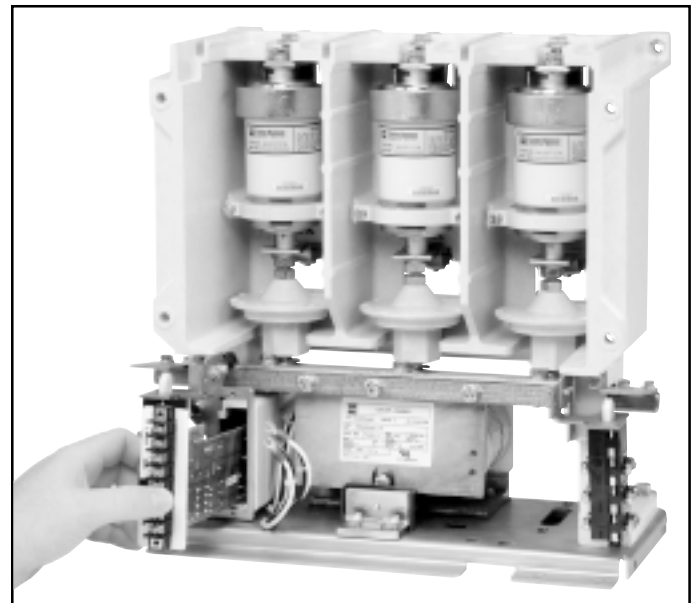

Fig. 14 Coil Control Board Removal

**TABLE III. CONTROL BOARD VOLTAGE SETTINGS**

Voltage	Switch				
	1	2	3	4	9
110/50	On	On	.	.	.
120/60	.	On	On	.	.
125DC	.	.	On	On	.
220/50	On	On	.	.	On
240/60	.	On	On	.	On

(Switch Off Unless Noted)

**TABLE IV. CONTROL BOARD DROPOUT SETTINGS**

Voltage	Switch			
	5 On	6 On	7 On	8 On
110/50	30	50	130	250
120/60	30	50	130	250
125DC	40	60	170	220
220/50	50	70	130	210
240/60	50	70	130	210

Note : Only one dropout switch 5-6-7-8 should be on at a time.

(Values Shown are in milliseconds)



Fig. 15 Contactor Ground Pad

**Code Plates**

200 Amp contactors should not be inserted into 400 amp cells. All 400 amp starters with SL contactors include a code plate attached to the inside of the left contactor rail. 200 amp SL contactors include an interference rod that will engage the code plate in a 400 amp starter cell, preventing the contactor from being installed. Refer to Figure 16.

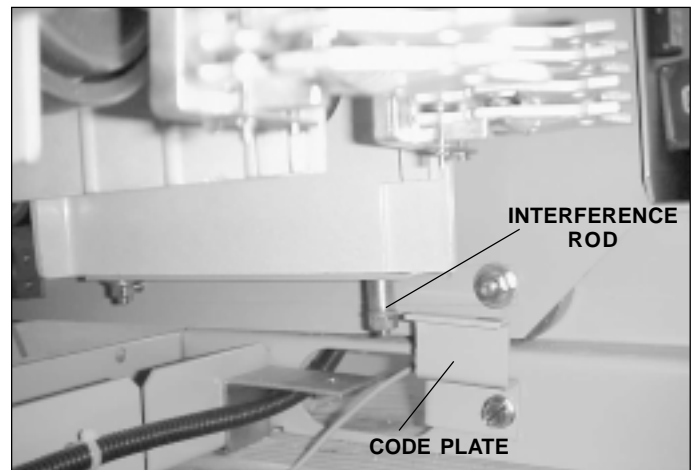

Fig. 16 Code plate in 400 amp cell preventing 200 amp contactor from being inserted



**WARNING.**

**DO NOT ATTEMPT TO FORCE A 200 AMP CONTACTOR INTO A 400 AMP CELL. DAMAGE TO THE CELL AND/OR CONTACTOR COULD OCCUR.**

**CONTACTOR-MOUNTED COMPONENTS**

To simplify installation and servicing, a number of related components are mounted on the Type SLS contactor chassis: a control power transformer with test plug and fuses, instrument-quality potential transformers with secondary fuses (when furnished), primary fuses for the control power and potential transformers, and load side fuse clips for the power circuit fuses. See Figures 6 and 17. The test-run plug is used to connect to an auxiliary source of control voltage when it is not inserted into the receptacle that is the output from the secondary of the control power transformer. This male test plug can be plugged into a standard polarized 120-volt (or 240-volt, depending on coil voltage rating) extension cord socket for testing the control circuit without energizing the medium-voltage controller at power circuit voltage. When the male plug is transferred to the extension cord, it automatically disconnects from the control power transformer to prevent feedback of high voltage into the power circuits. Check to

be sure no inadvertent bypass of this arrangement has been made in the wiring before relying on this safety feature.

### CONTACTOR HANDLING

Each contactor weighs about 150 pounds (68 kilograms). An oblong hole is provided in each sidesheet for lifting if desired.

A horizontal bar is provided at the front for pulling the contactor out of its cell, or for pushing it back into place.

When a type SLS contactor is installed in a medium-voltage controller it can be moved to a drawout position or removed from the enclosure as follows:



**WARNING.**

**ALL WORK ON THIS CONTACTOR SHOULD BE DONE WITH THE MAIN DISCONNECT DEVICE OPEN. AS WITH ANY CONTACTOR OF THIS VOLTAGE, THERE IS DANGER OF ELECTROCUTION AND/OR SEVERE BURNS. MAKE CERTAIN THAT POWER IS OFF. CHECK FOR VOLTAGE WITH VOLTAGE SENSOR OR A METER OF THE APPROPRIATE RANGE.**

1. If removal is planned, provide a lift truck or suitable platform to receive the contactor as it comes out.
2. **Make sure all circuits are deenergized.**
3. Remove the three power circuit fuses using the fuse puller supplied with the starter.
4. Disconnect the pull apart terminal blocks on the control panel and stow the wiring so that the cable will not be damaged.
5. Disconnect the isolating switch auxiliary contact pull-apart terminal blocks located on the upper right-hand side of the isolating switch.
6. Disconnect the contactor load-side cables from the controller load terminals.
7. Disconnect the ground wire connecting the contactor ground pad to the ground bus.
8. Loosen the hex-head bolt attaching the clevis at the end of the isolating switch interlock rod to the contactor mechanical interlock sufficiently far to free the clevis and rod. See Figure 7. Access to this bolt is from the low-voltage compartment. Where two contactors are bolted together by the factory and mechanically interlocked, (e.g., reversing or reduced voltage) the two are removed as a single package. The mechanical interlock and bus bar connections between them need not be removed. However, where three contactors are behind a single door and me-

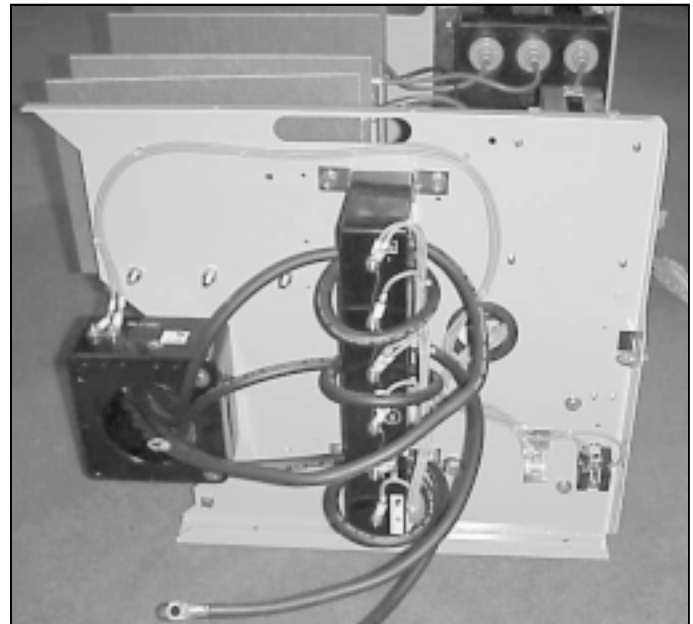

Fig. 17 Type SLS Contactor Side View

chanically interlocked, (e.g., for a single-winding two-speed motor) the two mechanical interlocks between the top and center contactors must also be disconnected to withdraw any contactor. Loosen the clevis bolts on each interlock arm of the top and center contactors sufficiently far to free the two interlock rods between them before attempting to withdraw a contactor. Remove the interlock rods, but mark them "front" and "rear" to insure correct reinstallation. **DO NOT DISTURB ANY FACTORY-SET INTERLOCK ADJUSTMENTS.**

9. Use a 0.50-inch socket wrench to remove the two horizontally-mounted positioning bolts located at the bottom front edge of the contactor sidesheets.
10. Carefully slide the contactor out to a balanced drawout position or onto the fork truck or platform.

To reinstall, reverse the procedure.

### INSTALLATION

This industrial type control is designed to be installed by adequately trained and qualified personnel with appropriate supervision. These instructions do not cover all details, variations, or combinations of the equipment, its storage, delivery, installation, check-out, safe operation, or maintenance. Care must be exercised to comply with local, state, and national regulations, as well as safety practices, for this class of equipment. See **START-UP PRECAUTIONS.**

For site preparation and general information regarding receiving, storage, and installation see I.B. 48001.

**WARNING**

**TALL STRUCTURE — MAY TIP OVER IF MISHANDLED.  
MAY CAUSE BODILY INJURY OR EQUIPMENT DAMAGE.**

**DO NOT REMOVE FROM SKID UNTIL READY TO  
SECURE IN PLACE. READ THE HANDLING  
INSTRUCTIONS IN I.B. 48001 BEFORE MOVING.**

Medium-voltage motor controllers are extremely heavy and the moving equipment used in handling must be capable of handling the weight of the motor controller. Confirm this capability prior to starting any handling operations with the controller.

The motor controller should be kept in an upright position unless specific instructions to the contrary are provided with the controller.

After a level installation site has been prepared, the Ampgard® assemblies positioned and fastened in place, and protective packaging removed, the individual controllers can be disassembled to permit access to conduit and wiring. Step-by-step disassembly procedures are shown on Pages 12, 13, 14, and 15. Following the recommended procedures will save time. All cable connections can be made by access through the front of the enclosure.

When there is access space behind the installation, the rear panel of the enclosure can be removed to facilitate wiring. Adequate space has been provided at the rear of the enclosure for medium-voltage line and load cables, while low-voltage cables may be conveniently arranged near the right-hand enclosure wall.

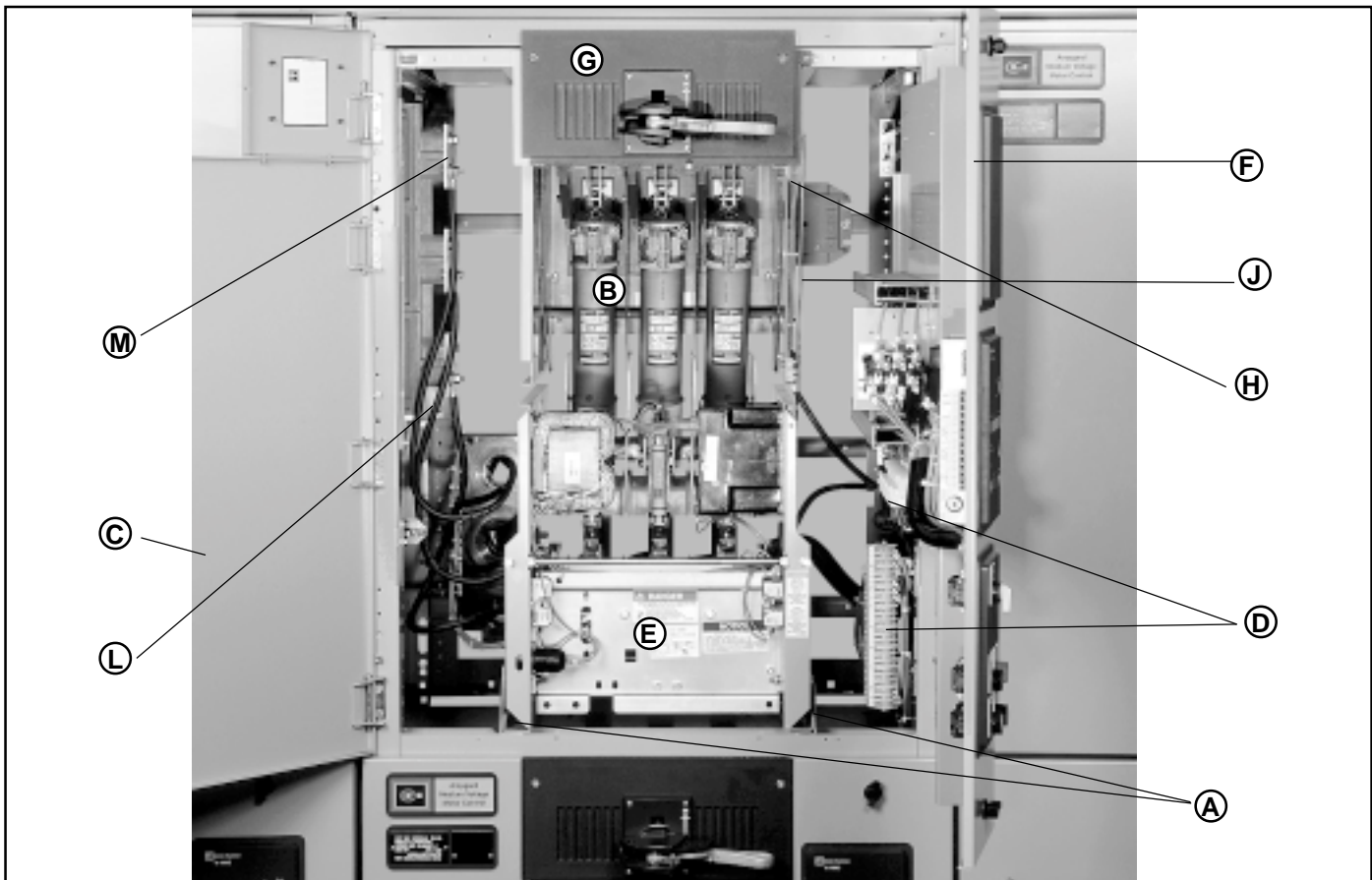

Fig. 18 Key Points In Disassembly

- A. POSITIONING BOLTS
- B. POWER CIRCUIT FUSES
- C. MEDIUM-VOLTAGE COMPARTMENT DOOR
- D. CONTROL TERMINAL BLOCKS
- E. VACUUM CONTACTOR
- F. LOW-VOLTAGE COMPARTMENT DOOR

- G. ISOLATING SWITCH
- H. ISOLATING SWITCH AUXILIARY CONTACT TERMINAL BLOCKS
- J. ISOLATING SWITCH MECHANICAL INTERLOCK
- L. CONTACTOR LOAD CABLES
- M. MOTOR CABLE CONNECTION



**1** Remove the two positioning bolts (A). Free the clevis attached to the mechanical interlock rod. See Figure 7 on Page 7. Save all hardware.



**2** Remove three power circuit fuses (B) using the fuse puller supplied. See operating instructions inside medium-voltage door (C).

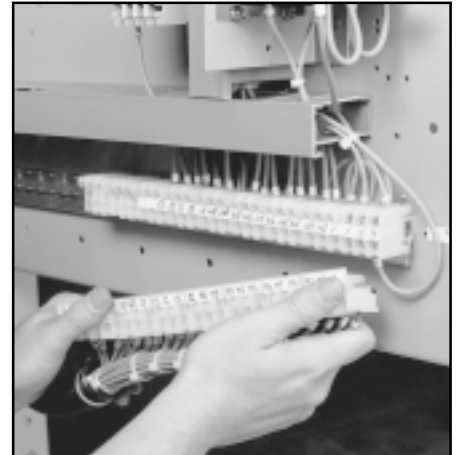

**3** Separate the contactor side of the control wires from the terminal block (D).



**4** Disconnect the auxiliary contact terminal blocks (H) on the isolating switch. Remove ground wire connection from contactor ground pad to ground bus.



**5** Unbolt contactor load cables from left sidewall of starter cell. Remove contactor (E) with a sharp pull forward.



**6** Part way out the contactor will reach a balanced position. Lower the contactor to the floor and slide it out of the way. The contactor weighs approximately 150 lbs. (68 kilograms). If a contactor is installed in an upper compartment, an industrial lift with a platform is necessary.



- 7** Free the isolating switch (H), by removing two hex head bolts as shown.



- 8** Pull the isolating switch forward. **CAUTION:** It has no latch and will pull completely out. However, it weighs only 75 lbs. (34 kilograms) and can usually be handled without a crane or lift.

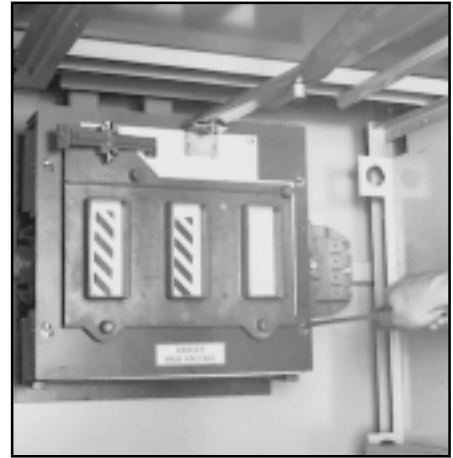

- 9** If no vertical bus bars are present and cable is used to connect power to the line stabs, loosen four pan head screws holding the barrier and shutter assembly approximately three turns. Lift the assembly up and off the screws. Disconnect the shutter drive lever using the keyhole in the lever.



- 10** Refer to load cable instruction tag located at motor terminals (M) for load wiring instructions. Controller is now ready to wire, both line and load.

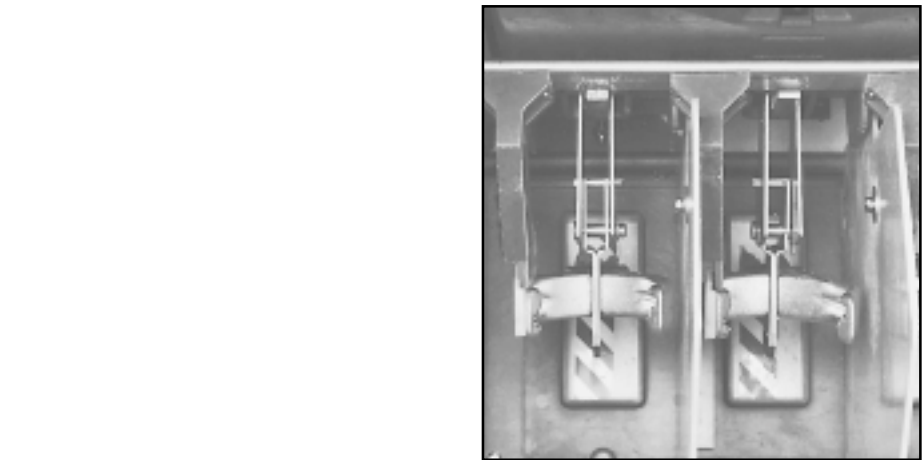

- 11** After wiring, reverse the procedure to reassemble. Slide the isolating switch in place and secure with two bolts. **Refer to Steps 7 and 8.**

- 12** Check to make sure each fuse clamp is in correct position in fuse locator. Refer to instructions on the starter.

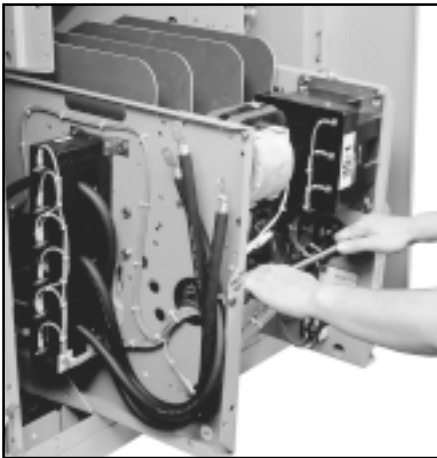

- 13** Return the contactor to its compartment. Reattach the two positioning bolts.



- 14** Reconnect the clevis attached to the mechanical interlock arm. Reconnect the isolating switch auxiliary contact terminal blocks. Reconnect the contactor control wire terminal blocks and ground wire. **Refer to Steps 3 and 4.**



- 15** Install the three power circuit fuses. Make sure each fuse is fully seated on the bottom fuse holder located on the contactor.

### START-UP PRECAUTIONS

Before attempting to put a newly installed motor controller into service, study the wiring diagram and instruction literature.

#### General Precautions. Be sure that:

1. The corresponding controller and motor are connected as shown on the Cutler-Hammer drawings. This is particularly essential in this class of motor controller as the fuse ratings, current transformers, and overload protection are based on the characteristics of the particular motor to be controlled.
2. The controller is connected to a suitable power supply with characteristics agreeing with motor and starter nameplate markings.
3. The motor and the machine it drives are properly lined up, bolted down, lubricated, free of obstructions, and ready to go.
4. Connections are neat, tight, of proper capacity and in agreement with the diagram.
5. Equipment has been cleaned of dirt, scraps of wire, tools, and all other foreign material.
6. THE INSULATION LEVEL OF THE STARTER IS CHECKED AND RECORDED BEFORE THE STARTER IS ENERGIZED. See **GENERAL MAINTENANCE**.

7. Enclosure door closes easily. Do not force the door closed but rather look for improperly positioned contactor, fuses, or isolating switch.
8. All safety precautions have been taken and the installation conforms with applicable regulations and safety practices.

#### For Isolating Switch. Be sure that:

1. The current-limiting motor-starting power circuit fuses have been properly installed. See the permanent operating instructions on the inside of the medium-voltage door.
2. The mechanical interlocking system operates freely to provide the intended protection.



**DANGER**

**OPERATE THE ISOLATING SWITCH ONLY WITH ALL DOORS CLOSED AND COMPLETELY LATCHED. THE ISOLATING SWITCH MAY FAIL TO INTERRUPT IF ITS RATING HAS BEEN EXCEEDED BY AN UNDETECTED INTERNAL FAULT.**

**For Contactor. Be sure that:**

1. THE FOUR PHASE BARRIERS ARE INSTALLED WHEN PROVIDED.
2. The contactor coil is electrically isolated, to prevent feedback into a control power transformer and a hazardous situation.
3. There has been a check, using an extension cord and a separate source of AC control circuit power, of the control circuit functions.

Operate the appropriate pushbuttons to close and open the contactor. If the contactor does not close fully or does not drop out fully, refer to the **CONTACTOR MAINTENANCE** section below.

Disconnect the extension cord and restore the plug into its socket on the contactor chassis.

**CHECK-OUT, VACUUM INTERRUPTERS**

**The dielectric strength of the interrupters should be checked before the contactor is energized for the first time** and regularly thereafter to detect at the earliest possible date any deterioration in the dielectric strength of the contact gap since this may result in an interruption failure. See Section in Vacuum Integrity Check.

**CHECK-OUT, MECHANICAL**

One of the features of Ampgard® motor control is the interlocking of the contactor and isolating switch which prevents **opening** the isolating switch when the contactor is closed, and prevents **closing** the isolating switch if the contactor is already closed due to some malfunction. Neither closing nor opening of the isolating switch under load is permissible. The isolating switch interlock rod does not move, except when the isolating switch is being opened or closed.

Similarly, **during the opening or closing** of the isolating switch, the interlock rod on the isolating switch drives the interlock arm of the SLS contactor clockwise so that the heavy end moves down to keep the contactor from closing. If the isolating switch interlock rod is not attached to the interlock arm of the contactor by the clevis shown in Figures 7 and 8, the natural weight of the interlock arm moves the arm to a position which prevents the contactor from closing.

All these interlocks are intended to protect against malfunction. But they should be tested with main POWER OFF prior to start-up (and at intervals thereafter) by simulating improper operation and sequencing of the contactor and isolating switch. Failure to interlock must be corrected before power is applied.

**DANGER**

**OPERATE THE ISOLATING SWITCH ONLY WITH ALL DOORS CLOSED AND COMPLETELY LATCHED. THE ISOLATING SWITCH MAY FAIL TO INTERRUPT IF ITS RATING HAS BEEN EXCEEDED BY AN UNDETECTED INTERNAL FAULT.**

**GENERAL MAINTENANCE**

Ampgard® motor controllers should be operated and maintained by authorized and qualified personnel only. Personnel authorized to operate the isolation switch and those authorized to inspect, adjust, or replace equipment inside the enclosure should have a complete understanding of the operation of the controller, and must have thorough training in the safety precautions to be followed when working with medium-voltage equipment.

**MAINTENANCE PRECAUTIONS**

There is a hazard of electric shock whenever working on or near electrical equipment. Turn off all power supplying the equipment before starting work. Lock out the disconnecting means in accordance with NFPA 70E, "Electrical Safety Requirements for Employee Safety In the Workplace." Where it is not feasible to de-energize the system, take the following precautions:

- a) Instruct persons working near exposed parts that are or may be energized to use practices (including appropriate apparel, equipment and tools) in accordance with NFPA 70E.
- b) Require persons working on exposed parts that are or may be energized to be qualified persons who have been trained to work on energized circuits.

For the purpose of these instructions, a qualified person is one who is familiar with the installation, construction, or operation of the equipment and the hazards involved. In addition, this person should have the following qualifications:

- a) Be trained and authorized to energize, de-energize, clear, ground, and tag circuits and equipment in accordance with established safety practices.
- b) Be trained in the proper care and use of protective equipment, such as rubber gloves, hard hat, safety glasses or face shields, flash clothing, etc., in accordance with established practices.



- c) Be trained in rendering first aid.
- d) Be knowledgeable with respect to electrical installation codes and standards, for example, the National Electrical Code (NEC).

### MAINTENANCE PROGRAM

A maintenance program should be established as soon as the controller has been installed and put into operation. After the controller has been inspected a number of times at monthly intervals and the conditions noted, the frequency of inspection can be increased or decreased to suit the conditions found.

Before attempting maintenance, consult the specific circuit diagrams supplied with the controller.

### Insulation Level

After installation, and before energizing the controller for the first time, the insulation resistance between poles, and from each pole to ground should be measured and recorded. It is not practical to specify an absolute value for this reading since it is dependent on other connected apparatus and conditions of service. However, any unusually low reading or abrupt reduction in a reading would indicate a possible source of trouble, and the cause should be investigated and corrected.

### Fuses

Inspect the current-limiting fuses after each fault-clearing operation, since this is the most severe service to which they will be subjected. Check the fuse resistance, and compare this value with a new fuse. A visual sign of an open fuse is provided by a colored indicator in the top of the fuse. This indicator pops up and is visible when the fuse is blown.

Use the fuse puller to remove and replace blown fuses. The fuse puller is stored alongside the contactor rail. The correct procedure for replacing fuses is described on the operating instruction panel which is permanently fastened inside the door to the medium-voltage compartment. This instruction panel also lists the correct fuse rating and fuse part number for that particular starter. The same type, rating and part number of power circuit fuses must be used for replacement in all cases. If preferred, fuses may be removed and replaced by hand.

If for any reason, there is doubt about the condition of a fuse, a simple test is to check its electrical continuity and resistance.

## CONTACTOR MAINTENANCE

### Maintenance



**DANGER**

**All work performed on this contactor should be done with the main disconnect device open and locked out. As with any contactor of this voltage, there is danger of electrocution and/or severe burns. Make certain that power is off. Check for voltage with voltage sensor or a meter of the appropriate range. Make certain that all transformers are isolated to prevent feedback and the resultant generation of high voltage.**

The contactor should be serviced on a regular basis. The time interval between maintenance checks is variable and dependant on factors such as environment, duty cycle, etc. Unless the experience of the maintenance personnel suggests a different service interval, the contactor should go through a checkout after each 50,000 operations or annually, whichever occurs first.

To service the contactor, remove it from the starter enclosure. Access to some components will require that the contactor truck be rotated 90 degrees so that it rests with the "front" of the truck on the floor or workbench. Some of the instructional photos show the base contactor without sidesheets. The contactor does not have to be removed from the sidesheets before service begins.

### General

The contactor should be kept clean and free from dust and other accumulated deposits. Dust can be removed from the contactor by blowing with dry air that is free from lubricants.

Verify wiring by grasping each wire and pulling to check tightness.

Check for hairline cracks in high stress areas such as mechanical interlock bracket, baseplate, auxiliary contact mounting bracket, etc.

Inspect for loose joints that produce excess heat and discolor conductors. Verify that insulation has not been damaged by high temperatures. Do not over-torque bolts while verifying tightness.

Hardware in the basic contactor is metric property class 8.8. Metric hardware can be identified by its clear plating, which allows the hardware to maintain a gray/silver appearance. Refer to Table IV for recommended torque values.

**TABLE IV. RECOMMENDED TORQUE VALUES FOR PROPERTY CLASS 8.8 METRIC HARDWARE**

Diameter (mm)	Torque N-m	lb-in	lb-ft
4	2.8 – 3.1	24 – 27	
5	5.6 – 6.2	49 – 55	
6	9.4 – 10.4	83 – 92	
8	22.9 – 25.4	203 – 225	17 – 19
10	45.5 – 50.6	402 – 447	34 – 37
12	79.2 – 88.0	701 – 779	58 – 65

Hardware on any components other than the basic contactor (i.e. main fuse supports, etc.) is grade 5 standard Imperial size. Imperial hardware can be identified by its yellow dichromate plating.

**TABLE V. RECOMMENDED TORQUE VALUES FOR GRADE 5 IMPERIAL HARDWARE**

Dia inches	Torque lb-ft
5/16	10-14
3/8	18-25
7/16	28-40
1/2	42-60
9/16	61-87
5/8	84-120

**Vacuum Integrity check****DANGER**

**THIS PROCEDURE REQUIRES THE USE OF A HIGH POTENTIAL TEST UNIT, WHICH PRODUCES HAZARDOUS VOLTAGES.**

**WARNING**

**APPLYING HIGH VOLTAGES ACROSS THE OPEN CONTACTS OF A VACUUM INTERRUPTER MAY PRODUCE X-RAYS. THE RADIATION MAY INCREASE WITH AN INCREASE IN THE VOLTAGE OR A DECREASE IN THE DISTANCE BETWEEN THE OPEN CONTACTS. THE LEVELS OF RADIATION GENERATED AT THE RECOMMENDED TEST VOLTAGES AND NORMAL CONTACTOR OPEN GAP SPACING ARE EXTREMELY LOW. HOWEVER, AS A PRECAUTIONARY MEASURE IT IS RECOMMENDED THAT ALL OPERATING PERSONNEL STAND AT LEAST THREE FEET AWAY FROM THE CONTACTOR WHILE PERFORMING THIS TEST.**

Vacuum contactors depend on the vacuum in each interrupter to successfully stop current flow to the connected load when the contactor opens.

The SL contactors are thoroughly tested at the factory prior to shipment. They can however be damaged by improper handling during shipment and storage. The integrity of the vacuum interrupters should therefore be verified before the contactor is energized for the first time. The check should also be made each time the contactor is serviced or repaired, otherwise the test should be performed each 50,000 operations or annually, whichever occurs first.

To verify the integrity of the vacuum interrupters a voltage of 16kV-ac should be applied across the open contacts of the interrupters. The voltage should be applied for 60 seconds without breakdown. Breakdown is defined as a current of 5mA or more flowing across the open contacts. Note that approximately 1mA of current will flow through each interrupter during the AC test due to the capacitance of the vacuum interrupter.

If a DC high potential test unit is used make certain that the peak voltage does not exceed 23kV, the peak of the corresponding AC RMS test voltage. A megger cannot be used to verify vacuum integrity due to its limited output voltage.

**Interrupter Wear Check**

The interrupters used in the SL contactor are designed for long electrical life. Replacement should be at 300,000 operations except in cases of plugging or jogging, which may require more frequent replacement. Verification of contact wear can be made by following the procedure below.

The overtravel gap for a new SL contactor is .100" and is set at the factory. As the contacts wear the overtravel is reduced. The SL interrupter design allows for .080" wear before replacement is required. To verify that the contacts

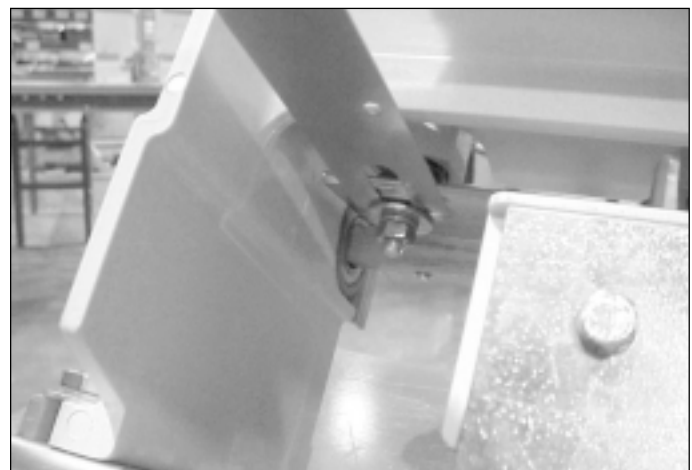

Fig. 19 – Interrupter Wear Check

are not worn beyond their allowable limits, close the contactor with rated control power. Insert the .020" contactor wear gauge, p/n 5259C11H01, between the operating plate and the washer on the lower insulator stem of each pole. Refer to Figure 19. If the gauge cannot be inserted on each pole, all three interrupters must be replaced. Refer to the section **VI Replacement** for instructions on replacing the interrupters.

### VI Replacement

If the vacuum interrupters fail the vacuum integrity or wear check, or if they have more than 300,000 operations, they must be replaced. The three interrupters should be replaced as a set.



**CAUTION**

**THERE ARE BELLOWS IN EACH INTERRUPTER THAT SEAL THE MOVING CONTACT FROM THE ATMOSPHERE. THESE BELLOWS ARE FRAGILE AND MUST BE PROTECTED FROM ANY TORSIONAL LOADING. AN APPROPRIATE TOOL MUST SUPPORT THE MACHINED FLATS ON EACH END OF THE INTERRUPTER WHEN TIGHTENING ANY HARDWARE ON THE INTERRUPTER. BOTTLE WRENCH, CUTLER-HAMMER PART NUMBER 4A36081H01, IS SUGGESTED FOR USE IN THIS APPLICATION.**

Remove each VI using the steps listed below:

1. Remove bolt securing the line bus to the lower terminal (Figure 20).
2. Remove bolt and shunt supports securing end of lower terminal to housing (Figure 21).
3. Loosen locknut securing threaded rod to top of standoff insulator (Figure 22).
4. Rotate insulator clockwise to screw insulator off threaded rod.
5. Remove clamp securing lower end of VI to housing (Figure 23).
6. Remove bolt securing VI to upper terminal (Figure 24).
7. Hold insulator down and rotate lower portion of VI assembly forward to remove (Figure 25).
8. Insert new VI assembly (reverse of step 7).
9. Install bolt securing VI to upper terminal, do not tighten (reverse of step 6).
10. Install bolt and shunt supports securing lower terminal to housing. When tightening insure shunt is straight and shunt supports are in correct position (reverse of step 2).

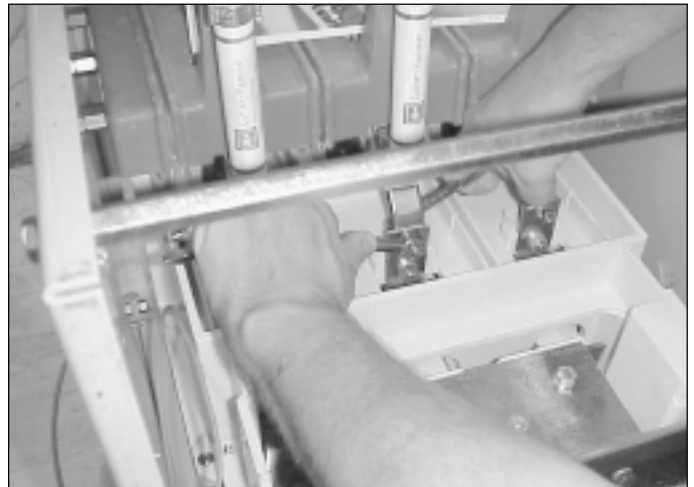

Fig. 20



Fig. 21

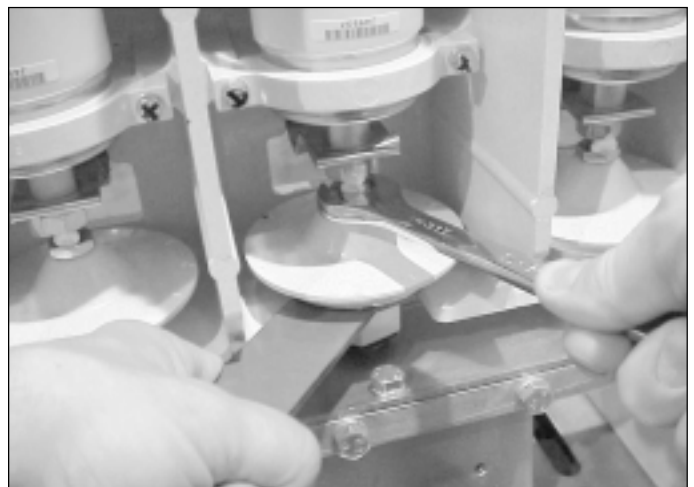

Fig. 22



Fig. 23

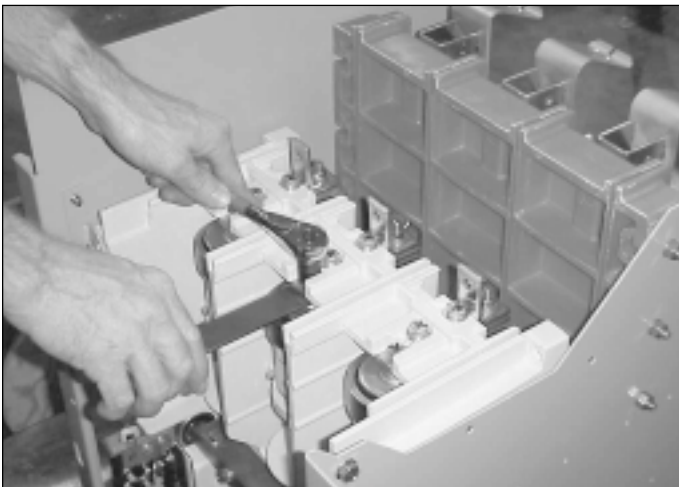

Fig. 24

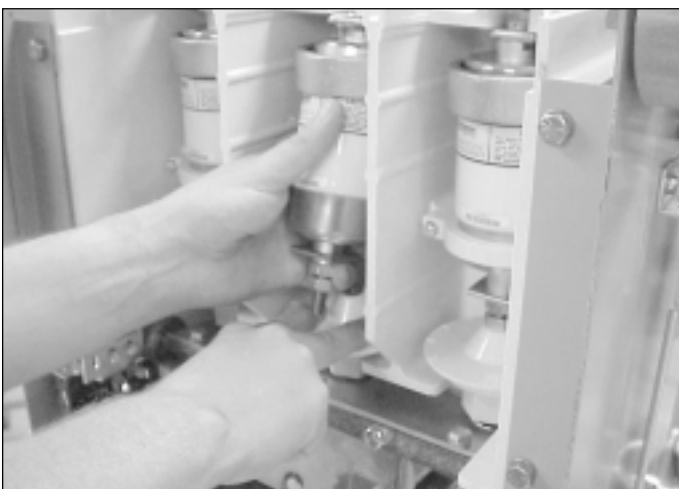

Fig. 25

11. Install bolt securing line bus to the lower terminal. Torque to 12 lb-ft (16.2 N-m) (reverse of step 1).
12. Tighten bolt securing VI to upper terminal while holding bottle wrench on upper VI stem. Torque to 200 lb-in (22.6 N-m). Insure the laminated shunt is not twisted.
13. Install clamp securing lower end of VI to housing (reverse of step 5).
14. Rotate insulator counter-clockwise approximately 3 to 4 turns to secure threaded rod to insulator.
15. Adjust VI's as outlined in the next section.

After 3 new VI's have been installed, set the proper open gap using the steps listed below. Two or three battery operated test lights or continuity testers are needed for the proper setting of the open gap.

#### Adjusting VI's

1. Attach test lights across the upper and lower terminals of each interrupter.
2. Rotate Insulator on middle phase bottle until light flickers. Rotate clockwise if light is not on, counter-clockwise if light is on.
3. From the point the light flickers, rotate insulator on middle phase bottle counter-clockwise three and two-thirds turns to establish a 5.5mm open gap. Use markings on insulator to verify correct rotation. (Two-thirds turn is equal to 8 divisions that are molded on the surface of the insulator.)
4. Slowly rotate the main shaft, closing the VI's, until the middle phase light is on. Adjust the insulators on the two outside phases so that the lights on all three phases come on simultaneously, (DO NOT MOVE THE INSULATOR ON THE MIDDLE PHASE) while rocking the main shaft open and closed.
5. Tighten locknuts securing threaded rod to top of each insulator. Use bottle wrench to insure standoff insulator does not rotate during this operation.
6. Perform test as described in section on **Vacuum Integrity Check** on page 18 before returning contactor to service.

#### Coil replacement

1. Remove the coil leads from terminals 5 and 6 on the control board. Cut the wire-tie securing the coil leads to the baseplate.
2. Remove the coil mounting angle by removing the two angle mounting bolts located on the bottom of the contactor baseplate. (Figure 26). Be careful not to allow the angle to move abruptly as the bolts are removed since there is pressure applied to the angle by the return spring.

3. Remove the lock nut holding the return spring bolt on the back of the mounting angle (Figure 27). Note: After removing locknut, count the threads protruding through the mounting angle to insure correct length during reassembly.
4. Unscrew the spring assembly by hand and remove from the angle (Figure 28).
5. Slip the two coils from the cores.
6. Install the two new coils over the cores. (Figure 29)
7. Thread the return spring assembly into the mounting angle until the locknut under the bottom spring retainer just contacts the angle. The number of threads protruding through the mounting angle should be the same as counted in step 3 above. Do not overtighten since this would compress the return spring and prevent the proper force from being applied to the operating plate on opening. The rear locknut for the return bolt should then be tightened on the back of the angle.

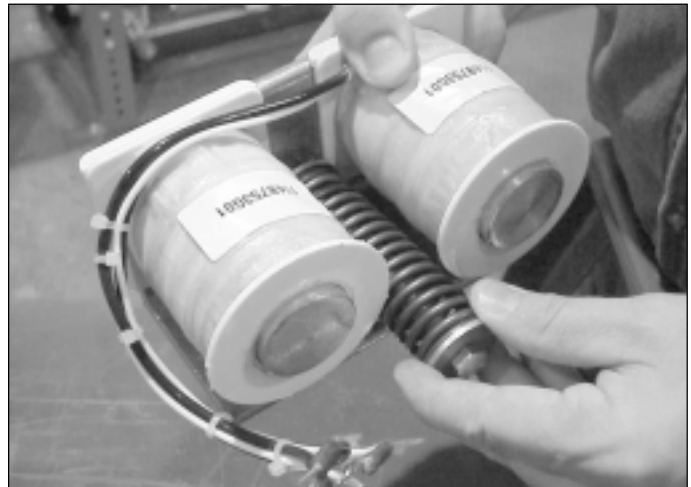

Fig. 28 – Unscrew the return spring assembly



Fig. 26 – Remove the coil mounting angle



Fig. 29 – Install new coils on cores



Fig. 27 – Remove the locknut securing the return spring bolt

8. Secure the angle to the contactor baseplate using the two mounting bolts. Sufficient force must be applied to the angle to compress the return spring and allow the threaded holes in the angle to align with the appropriate holes in the baseplate.
9. Connect the coil leads to the appropriate terminals on the control board. Secure the leads using a wire tie and the hole in the baseplate to insure that the leads do not become abraded. Before the contactor is reinstalled, verify proper operation using test power. When power is applied, the contactor should close cleanly. When power is removed, the moving armature should securely contact the return assembly.

### Control Board Check and Replacement

To verify the output of the control board, apply rated control voltage to terminals one and two. Terminals 3 and 4 must remain connected with the factory-installed jumper.



**WARNING**

**VERIFY THAT THE APPLIED POWER CANNOT BE FED BACK INTO ANY CPT OR OTHER CIRCUIT, WHICH MAY GENERATE DANGEROUS VOLTAGES.**

Using a standard hand-held multimeter, check the dc output of the board at terminals 5 and 6. The voltage should be approximately 12 to 16 volts. If there is no output, the board must be replaced. If there is an output voltage, but it is not within this range, remove the board and verify the dipswitch settings.

To remove the board, wires connected to terminals 1, 2, 5, and 6 (7 and 8 also if mechanical latch is installed) must be disconnected. Make certain that the wires are properly marked before disconnecting to insure the ability to reconnect them to the proper terminal. (The jumper on terminals 3 and 4 may remain.) After the wires are disconnected, loosen the mounting screws located at the top and the bottom of the terminal block. The board may now be withdrawn from its mounting compartment.

Before a new board is installed, make certain that the dipswitches are properly set. Installation is the opposite of removal.



*Fig. 30 – Remove the two mounting screws securing the contact assembly to bearing retainer*

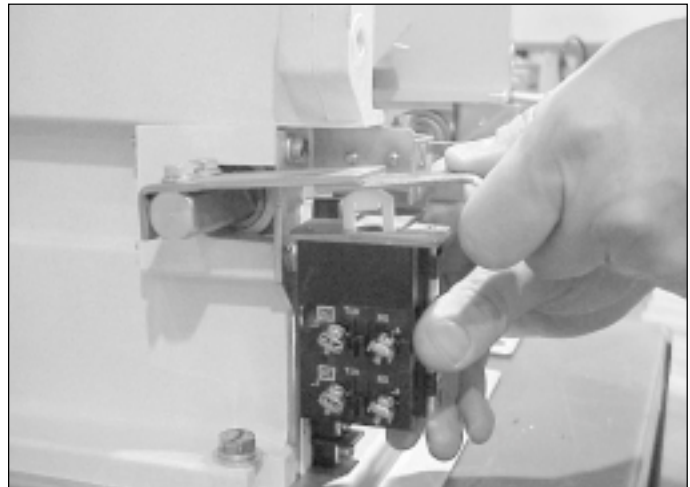

*Fig. 31 – Adjust the gap between plunger and operating arm to .110 inches*

### Stop Assembly Replacement

If the stop assembly becomes worn it should be replaced.

To replace, close the contactor with test power. Remove the two bolts securing the assembly to the baseplate. Install a new assembly.

### Auxiliary Contact Maintenance and Replacement

If standard contact blocks become oxidized due to very low current levels passing through the contacts, they may be cleaned by periodically disconnecting them from the circuit and circulating approximately 10 amps through the contacts for a short period of time.

If one or more of the auxiliary contacts fail, it is recommended that the complete contact block assembly be replaced. Disconnect wiring to each contact, making sure to properly mark each wire to insure proper reconnection. Remove the two mounting screws securing the contact assembly to the bearing retainer. Install the replacement assembly, securing with the two mounting screws. The contacts are properly adjusted when the plunger to operating arm gap is .110 inches. (Figure 31)

### Insulation Level Check

After installation and before energizing the contactor for the first time, the insulation level should be checked and recorded. Check the resistance between poles and from each pole to ground with a megger. Record all readings. It is not practical to specify an absolute value for this reading since it is dependent on other connected apparatus and conditions of service. However, any unusually low readings (below 1 meg per 1000 volts) or abrupt reduction in a reading would indicate a possible source of trouble, and the cause should be investigated

and corrected. As previously discussed, the insulation level check cannot verify vacuum interrupter integrity.

### Contact Resistance Check

Testing that measures the contact resistance of the VI's is not recommended since the results can vary widely on good contacts. If a resistance check is performed, the best results will be with a test module that will force 50 to 100 amps through the contacts while measuring resistance. Any value under 300 micro-ohms can be considered typical, although higher readings may be measured if the test equipment is not connected near the contactor terminals.

## ISOLATING SWITCH MAINTENANCE



**DANGER**

**OPERATE THE ISOLATING SWITCH ONLY WITH ALL DOORS CLOSED AND COMPLETELY LATCHED. THE ISOLATING SWITCH MAY FAIL TO INTERRUPT IF ITS RATING HAS BEEN EXCEEDED BY AN UNDETECTED INTERNAL FAULT.**

When the isolating switch is removed from the starter structure, a latch lever on the shutter assembly is activated. It is designed to hold the insulating shutter closed. This latch may be deliberately by-passed and the shutter moved to the open position. Caution should be observed since the exposed line terminal stabs of the starter may be energized at line potential.

When the isolating switch is replaced in the structure, the latch lever is automatically released to allow the shutter to operate normally.

### Lubrication

Periodically, apply a light coating of Dow Corning DC-4 high temperature silicone grease (or equivalent) to the tips of the fuse jaw fingers where they engage the line terminal stabs. Also clean and lubricate the tray guide rails of the isolating switch.

### Welded Jaws or Contacts

In the unlikely event that either the isolating switch fuse jaws or the contactor contacts should weld closed, or if an event should occur such that the isolating switch handle cannot be moved from the ON to the OFF position, provision has been made so that the door to the medium-voltage compartment can be opened in an emergency. The door can be opened by using the following procedure:

1. Make sure that the main incoming power line is de-energized, to avoid a hazardous situation when the door is opened.
2. Remove the four screws holding the rectangular handle housing of the isolating switch to the front casting. (See Figure 5.)
3. Disconnect the leads between the isolating switch auxiliary switches and their pull-apart terminal blocks.
4. The complete handle housing can now be pushed up far enough to provide clearance for opening the door and any maintenance to be carried out.

As a final precaution before touching any of the electrical parts of the starter with the isolating switch removed, visually check to make certain that the shutter is closed, the green and white striped labels are visible, the grounding fingers are in contact with the ground bar, and the tips of the fuse fingers are visible.

### Auxiliary Contact Replacement

The auxiliary switch kit, part number 2147A01G01, consisting of two auxiliary contact switches mounted to a spring plate and leads, is designed for replacing auxiliary switches used with Ampgard® isolating switches. The kit includes two switch mechanisms, each with an inductive-load rating of 20 amperes at not more than 250 VAC. These switches serve as the low-voltage cutoff switch.

Assemble the auxiliary switches as shown in Figure 32. Carefully remove the old switches from the rear of the door interlock spring housing. Do not remove the spring or door interlock pin. Discard the old spring plate. Use spring plate mounting hardware to mount the auxiliary switch assembly to the spring housing.

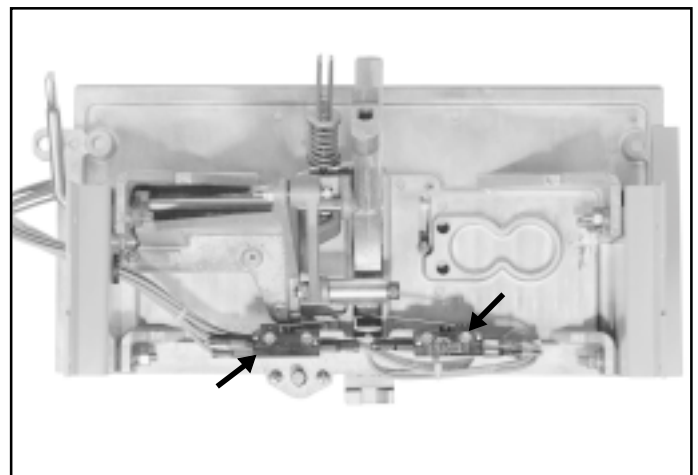

Fig. 32 Auxiliary Switch Installation

**INDEX**

	<u>Page</u>		<u>Page</u>
Ampgard® Components .....	2	Insulation Level .....	17
Auxiliary Contacts for Contactor .....	9	Isolating Switch .....	4
Auxiliary Contacts for Isolating Switch .....	23	Isolating Switch / Contactor Interlock .....	7
Auxiliary Contact Replacement .....	22	Isolating Switch Handle Positions .....	4
Checkout Mechanical .....	16	Isolating Switch Maintenance .....	23
Checkout, Vacuum Interrupters .....	16	Line Stab Insulating Shutter .....	7
Coil Replacement .....	20	Low-Voltage Components .....	2
Contact Wear Check .....	18	Low-Voltage Cut-Off Switch .....	4
Contactor, General Information .....	8	Low-Voltage Cut-Off Switch Replacement .....	23
Contactor Handling .....	11	Lubrication .....	23
Contactor / Isolating Switch Interlock .....	7	Maintenance Precautions .....	16
Contactor Maintenance .....	17	Maintenance Program .....	17
Contactor Positions .....	9	Mechanical Interlocks .....	5
Controller, Ampgard® .....	1	Medium-Voltage Components .....	2
Disassembly, Key Points .....	12	Operating Coil .....	20
Door Interlock .....	5	Start-Up Precautions .....	15
Enclosure .....	5	Vacuum Interrupter Replacement .....	19
Fuses .....	4, 16	Vacuum Interrupters Wear Check .....	18
General Maintenance .....	16	Welded Jaws or Contacts .....	23
Installation .....	11		

**Cutler-Hammer**

221 Heywood Road  
Arden, NC 28704