

# GeneSys™

## Air-Cooled Rotary Screw Chillers

Models AGS 230B to AGS 475B  
230 to 475 Tons, 805 to 1662 kW  
HFC-134a  
60 Hz



**Cutaway View of a Two-Compressor AGS Chiller, Typical of Models AGS 230B through 320B. Models AGS 340B Through AGS 475B Are Similar But With Three Compressors And Three Condenser Sections.**

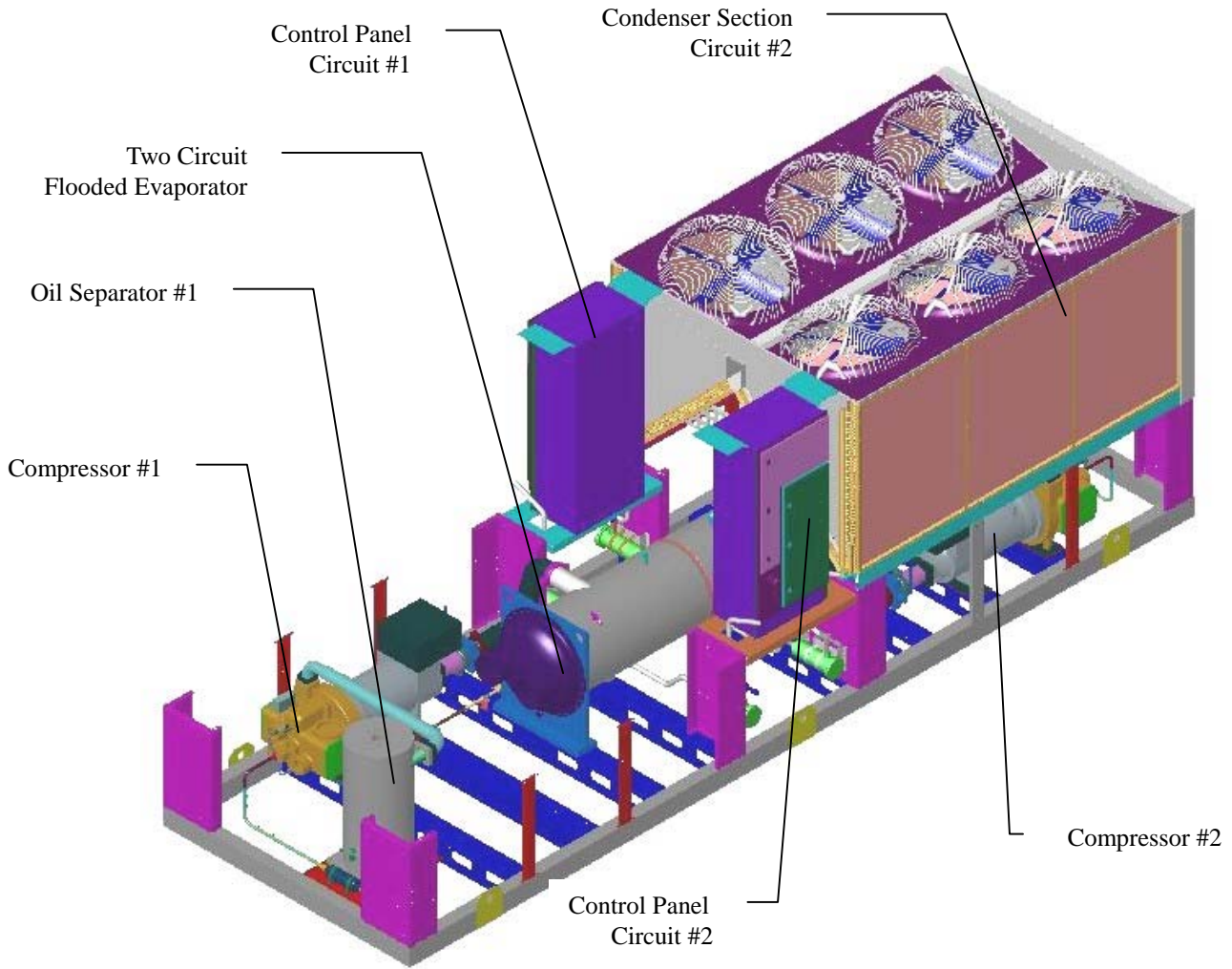

**Model Nomenclature**

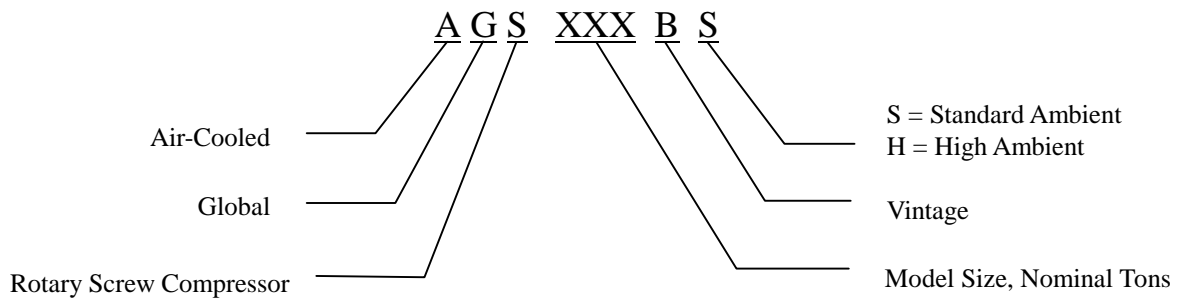

## Table of Contents

Introduction .....	4
Customer Benefits .....	5
<i>GeneSys</i> Features .....	7
Controls .....	10
Protocol Selectability™ .....	11
Selection Procedures .....	13
Performance Adjustment Factors .....	14
Performance Data .....	16
Pressure Drop .....	21
Sound Data .....	22
Electrical Data .....	26
Field Wiring Diagram.....	31
Physical Data.....	32
Dimensions, AGS .....	35
Installation and Application.....	40
Chilled Water Systems .....	49
Electrical Connections.....	53
Standard Features .....	54
Optional Features .....	56
Limited Warranty.....	58
Specifications .....	59



LONMARK<sup>®</sup> 3.3

Unit controllers are LONMARK  
certified with the optional  
LONWORKS communications

## Manufactured in an ISO Certified Facility

Document:	Cat AGSB-60
Issue Date:	May 2005
Replaces:	PM AGS-1

Information covers McQuay International products at the time of publication  
and we reserve the right to make changes in design and construction at anytime without notice.

®™ The following are trademarks or registered trademarks of their respective companies: BACnet from ASHRAE; LONMARK and LONWORKS from Echelon Corporation; GeneSys, McQuay and MicroTech II from McQuay International

# Introduction

---

The GeneSys™ air-cooled screw chillers continue McQuay's legacy of high quality, high efficiency, latest technology and quiet operation. Model AGS units utilize a new compressor design utilizing R-134a refrigerant. Superior control is used with the new MicroTech II® family of controllers with Protocol Selectability. GeneSys continues McQuay's position of being the only air-cooled screw compressor chiller with superior solid state starters as standard equipment. Perhaps most important, GeneSys continues McQuay's reputation for quiet operation, making GeneSys "neighborhood friendly". GeneSys provides the best overall value in air-cooled screw chillers available today!

---

**The AGS chillers are equipped with state-of-the-art solid state starters to provide stepless acceleration, controlled deceleration, and advanced motor/compressor protection features. McQuay is the only manufacturer to provide this advanced technology as standard equipment on air-cooled chillers.**

---

## UNSURPASSED EFFICIENCY

- Exceeds ASHRAE 90.1 October 2001 efficiency standard
- Single-screw compressor design
- Electronic expansion valve control
- Flooded evaporator
- High efficiency lanced condenser fins

## QUIET OPERATION

- Continuing the legacy of McQuay chillers
- Virtually vibration-free operation

## OUTSTANDING RELIABILITY

- Solid State Starters for smooth acceleration and deceleration
- Independent refrigerant circuits
- Rugged compressor design
- Low thrust loads on bearings
- Advanced composite gaterotor material
- Multiple compressors with independent controllers
- Proactive control logic
- Full factory-run-testing to optimize trouble-free operation
- McQuayService start-up

## SUPERIOR CONTROL LOGIC

- Precise control and improved efficiency
- Easy to read 4-line by 20-character LCD display
- Protocol Selectability™ for simple BAS interface, supports LONTALK®, BACnet® or Modbus®
- Superior unit reliability under extreme operating conditions

# Customer Benefits

---

Many customer benefits make GeneSys the best overall value for your cooling needs. Compare GeneSys to other offerings before selecting a chiller.

## Low Operating Costs -- High Efficiency Operation

Any product catalog will mention high efficiency operation. In our case, we have the performance to support this claim. GeneSys uses the new McQuay screw compressor with latest technology. GeneSys was designed with large condenser coil surface areas for maximum heat transfer. Large condenser fans are used to move large volumes of air across the heat exchangers. Flooded evaporators provide superior performance compared to direct expansion type vessels.

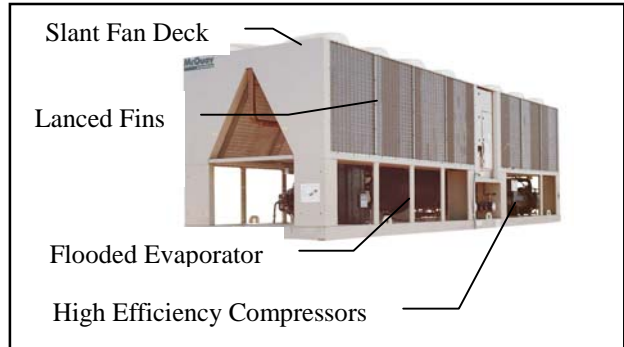

Our performance numbers speak for themselves, beginning on page 16. For two compressor models, the full load EER ranges up to 10.5. Three compressor units have full load EERs up to 10.6. Many other available competitive chillers struggle to reach the minimum allowable full load EER of 9.6 as required by ASHRAE 90.1, October 2001. Part load performance with IPLVs up to 14.0 is part of the GeneSys offering.

## Superior Motor Control -- Solid State Starters -- Our Standard Offering

GeneSys chillers are the ONLY units available that provide the superior motor control of solid-state starters as standard. The benefits are impressive.

A primary benefit is that the compressors are started slowly, requiring from three to seven seconds to go from a stop to full-speed condition. This reduces vibration and compressor stresses for longer life. If liquid refrigerant is present at the compressor intake, the slow acceleration easily moves the liquid out without damage to the compressor.

Perhaps more important is the slow deceleration when operation is no longer required. The traditional jerking and backward rotation allowed by conventional starters is eliminated with solid-state starters. Again, extended compressor life is expected.

Another great benefit is the superior electrical system monitoring. In the event of main electrical power problems, the solid-state starters tightly monitor the power quality and make protective decisions to prevent compressor motor damage. See page 8 for a full description.

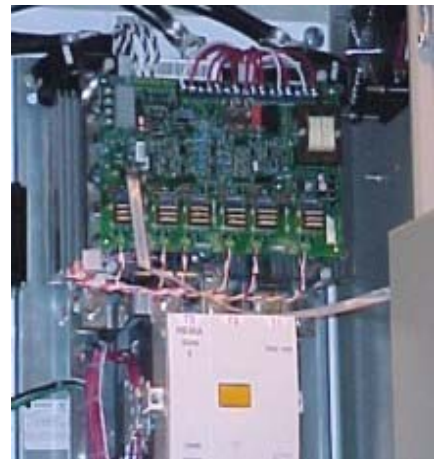



## Quietest Operation – “Neighborhood Friendly”

If there is one feature that sets GeneSys apart from other screw chillers, it is the low operating sound levels. The primary reason for quiet operation is the compressor design itself. McQuay’s latest compressor design continues the philosophy of a single main rotor with two adjacent rotating gaterotors, making gas flow velocities and subsequent noise levels the lowest available. This compressor design is unique and proven by years of excellent service. Condenser fans are selected for both good performance and low sound levels.

**GeneSys** sound data is proudly presented in this catalog for an easy comparison with other competitive offerings. Although others claim low sound levels, it is difficult to find their published sound data to support their claims. See page 23 in this catalog for the details.

## MicroTech II® Controls

The MicroTech II controller provides an easy-to-use control environment. The control logic is designed to provide maximum efficiency, to continue operation in unusual operating conditions and provide a history of operating conditions.



Perhaps the greatest benefit is McQuay’s Protocol Selectability® feature for interfacing with your building automation system. MicroTech II control allows direct interfacing with most building control systems that utilize LONTALK®, BACnet® or Modbus® standard protocols. See the complete control description on page 10 in this catalog.

The AGS units utilize distributed control, with each refrigerant circuit having a dedicated microprocessor, plus a unit controller that looks after issues that affect the entire unit. Unit reliability is greatly improved because if any compressor controller should malfunction, the remaining controllers are unaffected and their compressors will continue to operate normally.

## Summary

Four major benefits separate the GeneSys chiller from a typical air-cooled screw chiller. Consider the following:

1. Superior control with the new MicroTech II controller family
2. Superior motor control with solid state starters
3. Low operating costs with our high efficiency design
4. Very quiet operation

# GeneSys Features

---

## Compressor

### Unsurpassed Efficiency

- Zero clearance fit between the two gaterotors and main screw rotor virtually eliminates leakage between the high and low-pressure sides during compression. Special gaterotor material made from an advanced composite, temperature stable, material makes a zero clearance design possible.
- The AGS air-cooled chiller is equipped with the most advanced means of refrigerant flow control available. An electronic expansion valve, coupled with the MicroTech II controller's control logic, provides excellent efficiencies at both full and part load operation.
- Modulated, stepless unloading precisely matches compressor capacity to load.

### Outstanding Reliability

- Full factory testing of the unit with water hookups helps provides a trouble-free start-up. Extensive quality control checks during testing means that each equipment protection and operating control is properly adjusted and operates correctly before it leaves the factory. Factory-installed options minimize field expenses and startup labor.
- The rugged design of the single-screw compressor makes it tolerant of liquid slugging. The AGS screw chiller will start and operate under conditions that would often destroy other compressors.
- Very low loading enhances the bearing and compressor reliability. Due to symmetrical compression taking place on both sides of the main screw rotor, balanced forces result in the elimination of the large radial force loads inherent in twin-screw compressors.
- Integral to the basic design of the single-screw compressor, the main screw rotor shaft and the gaterotor shafts cross at right angles in the compressor. The result is ample space to locate heavy duty bearings and increase compressor reliability since no limitations are placed on bearing design as found in twin-screw compressors.

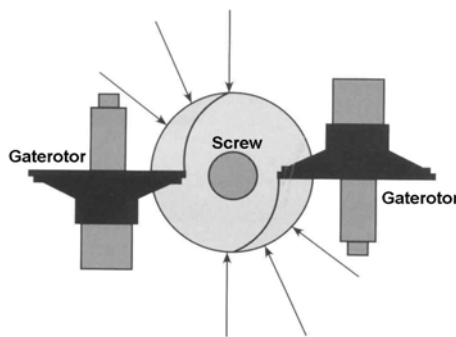

*Balanced radial forces*

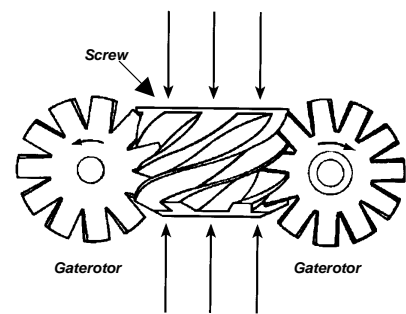

*Balanced axial forces*

- Recent technological advancements have made a composite material available that prevents premature wear on the gaterotor. The composite material is made from a material designed for strength, temperature-stability and durability.

## Flooded Evaporator

- Flooded evaporators are well recognized to be more efficient on large tonnage R-134a chillers than direct expansion evaporators. Water filled tubes are immersed in boiling liquid refrigerant for maximum heat transfer efficiency.

## "W" Shaped Condenser Coils

- The McQuay designed "W" shaped, lanced fin, condenser coil provides the maximum condenser heat transfer per foot of unit length. This translates to a smaller footprint, less structural elements and smaller pad size. McQuay's unique slanted fan deck helps improve unit efficiency and reduces hot air recirculation.

## Excellent Serviceability

- Field serviceability has not been sacrificed to meet design performance objectives. Compressors are equipped with discharge check valves and an optional suction service valve is available.
- Compressors are located on the outside edges of the base allowing ready access.
- The "W" shaped coil provides excellent headroom under the unit for inspection and service.
- The MicroTech II control gives detailed information on the causes of an alarm or fault.

## Standard Solid State Starters

The addition of solid-state starters as standard equipment (a McQuay exclusive) on the AGS units takes a giant step forward in motor/compressor protection against failures from unit or electrical faults. They include self-diagnostics, metering and display. The starters provide smooth, slow, stepless acceleration and controlled, slow, deceleration, reducing mechanical and electrical stress for even greater compressor/motor life. Some of the information available to the operator or service technician on each starter LED display follows:

Operating Messages	Fault Messages
Line voltage not present	System power not three phase
Voltage present, starter ready	Phase sequence incorrect
Motor accelerating	Line frequency less than 25 Hz
Motor at full speed	Line frequency more than 72 Hz
Motor at full speed, ramp time expired	Excessive current unbalance
Stop command received, motor decelerating	Operating parameters lost
overload has reached 90% to 99%	No current after "Run" command
overload at 100%, motor stopped	Undercurrent trip occurred
Passcode enabled	Control power too low
Passcode disabled	Motor stalled during acceleration
% Thermal overload content	External fault

Power Panel



## Platform

The structural steel base, G-90 galvanized steel structural members and sheet-metal panels are painted with corrosion-resistant, 500-hour salt spray paint (per ASTM B117). This finish enhances the appearance of the unit and deters corrosion.



**Figure 1, Piping Schematic with Flooded Evaporator (one circuit shown)**

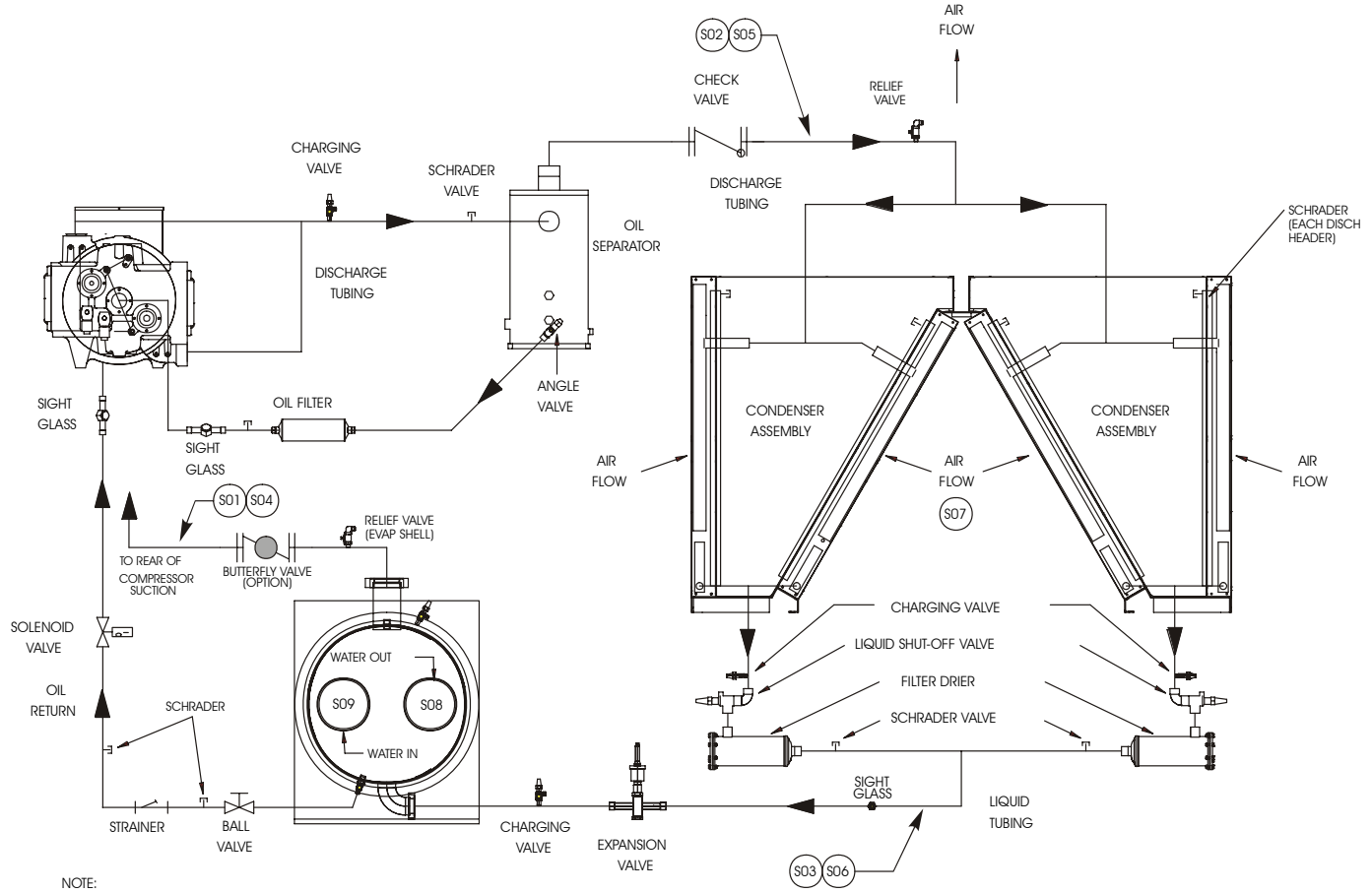

NOTE:  
PIPING SHOWN FOR ONE CIRCUIT OF UNIT.

SENSOR LOCATION CHART			
SENSOR NUMBER	DESCRIPTION	SENSOR NUMBER	DESCRIPTION
S01	EVAP. PRESS. TRANSDUCER	S06	LIQUID LINE TEMPERATURE
S02	DISCH. PRESS. TRANSDUCER	S07	OUTSIDE AIR TEMPERATURE
S03	LIQUID PRESS. TRANSDUCER	S08	EVAP. LEAVING WATER TEMP.
S04	SUCTION TEMPERATURE	S09	EVAP. ENTERING WATER TEMP.
S05	DISCHARGE TEMPERATURE		

## Electronic Expansion Valve

The AGS air-cooled chiller is equipped with the most advanced means of refrigerant flow control available. An electronic expansion valve coupled with the MicroTech II controller provides excellent operating efficiencies both at full and part load operation.

Unlike conventional thermal expansion valves, which require a large pressure drop across the valve and result in higher condenser head pressure, the electronic valve does not need a large pressure drop across it to operate effectively. During part load operation the electronic valve allows the system to operate at lower condensing pressure, minimizes suction line superheat and provides for a more stable system operation. Unit efficiencies are dramatically improved. The electronic expansion valve is an excellent choice of control for the AGS chiller line, providing precise control with a very fast response time.

At unit shutdown, the expansion valve will close tight to provide a positive shut-off downstream of the filter-drier.

# Controls

---

## **MicroTech II<sup>®</sup> Controller, The Ultimate Control System**

The controller provides a user-friendly environment for the operator. The control logic is designed to provide maximum efficiency, to continue safe operation in unusual operating conditions and provide a history of operating conditions.

- Distributed control architecture enhances unit reliability. Each compressor circuit has its own microprocessor controller so that if one controller should be inoperative, the other circuits are unaffected and will continue to run. An independent unit controller tends to issues that affect the entire unit.
- A logic control system employed in the AGS screw chiller looks at several key operating parameters and positions the electronic expansion valve for optimum efficiency at all compressor capacities. Intelligent fan staging and use of variable frequency fan drive also contributes to optimizing unit efficiency at all operating conditions.
- The MicroTech II controller is a new generation of MicroTech control, already considered superior to all other chiller control systems on reciprocating, scroll, and centrifugal chillers. This advanced microprocessor-based control maintains a precise and stable leaving chilled fluid temperature. Utilization of advanced logic means compressor cycling is minimized, reducing wear on both compressor and starting components.
- Stand-alone unit controls designed with the system operator in mind provide access to the unit temperatures, pressures, setpoints, operating states, and alarm messages. The MicroTech II controllers include password protection to guard against unauthorized or accidental setpoint or parameter changes. Each compressor circuit has a dedicated controller. In the event of a compressor-controller failure, the remaining compressor(s) will remain operational.
- Complete instrumentation with state-of-the-art pressure transducers, temperature sensors and optical oil level sensors for unparalleled operator information and diagnostics.
- Superior discharge pressure control that maximizes unit efficiency by determining optimum condenser fan operation. At least 6 and as many as 8 stages of heat rejection per circuit are provided.
- MicroTech II controllers have a proactive limit control feature that keeps the unit online when selected operating parameters start to exceed design settings. For example, should the discharge pressure start to climb for some reason, rather than shutting down the unit, the control will inhibit capacity increase to prevent further heat rejection to the condenser. If the pressure continues to climb, the control will unload the compressor in an attempt to keep the pressure within bounds. Either of these actions will illuminate a signal on the controller and also be recorded in the fault register. If these two defenses fail, and the pressure still continues to rise, the control will shut the compressor off at the shut off setpoint.
- The operator interface is through a 4-line by-20 character/line liquid crystal display and 6-key keypad mounted on the unit controller. Its layout follows.

## Keypad/Display

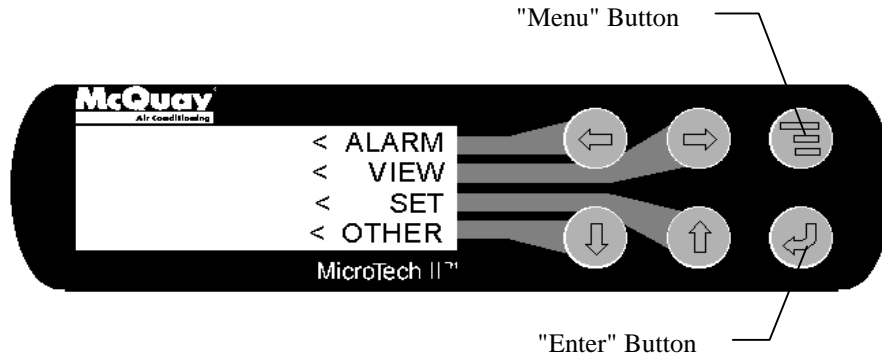

## Protocol Selectability™

Perhaps the greatest benefit is the Protocol Selectability® feature for interfacing with your building automation system. The simple factory addition (or field installation) of an optional communication module to the protocol certified controller allows interface with standard protocol such as:

- BACnet/IP (network physical wire is 4 pair Ethernet cable with minimum transmission of 10 Mbps)
- BACnet MS/TP (network physical wire is twisted pair, RS485)
- BACnet Ethernet
- LONTALK (network physical configuration is FTT-10A)
- Modbus RTU

### Building Automation System of Your Choice



The result can be reduced installation costs, greater reliability, and a seamless operator interface with all equipment in the building. The interface module can also be added in the field to existing units.

**Table 1, Typical MicroTech II Data Points**

Typical Data Points <sup>1</sup> (W = Write, R = Read)					
Active Setpoint	R	Compressor Select	W	Evap Water Pump Status	R
Actual Capacity	R	Compressor Starts	R	Ice Setpoint	W
Capacity Limit Output	R	Cool Setpoint	W	Liquid Line Refrigerant Pressure	R
Capacity Limit Setpoint	W	Current Alarm	R	Liquid Line Refrigerant Temp	R
Chiller Enable	W	Default Values	W	Maximum Send Time	W
Chiller Limited	R	Evap EWT	R	Minimum Send Time	W
Chiller Local/Remote	R	Evap Flow Switch Status	R	Network Clear Alarm	W
Chiller Mode Output	R	Evap LWT for Unit	R	Outdoor Air Temp	R
Chiller Mode Setpoint	W	Evap LWT for Compressor	R	Pump Select	W
Chiller On/Off	R	Evap Pump Run Hours	R	Run Enabled	R
Chiller Status	R	Evap Refrigerant Pressure	R2		
Compressor Discharge Temp	R	Evap Sat. Refrigerant Temp	R2		

NOTE: R = Read, W = Write

## Optional Remote Interface Panel

In addition to the unit-mounted user interface provided with MicroTech II controls, the AGZ chillers can be individually equipped with a remote user interface. It provides convenient access to unit diagnostics and control adjustments, without having to access a rooftop or outdoor location. A separate remote panel is required for each chiller on a job site.

Each remote user interface is similar to its unit-mounted counterpart and offers the same functionality, including:

- Touch sensitive keypad with a 4 line by 20-character display format.
- Digital display of messages in English language.
- All operating conditions, system alarms, control parameters and schedules are monitored.

### Features

- Can be wired up to 1,640 feet (500 meters) from the unit for flexibility in placing each remote user interface within your building.
- The main control is isolated from the remote user interface wiring so that wiring problems are less likely to damage the unit user interface.

### Benefits

- Allows you to access the user interface for each unit from one location, inside the building.
- Users need to learn one format because the remote user interface is identical to the unit-mounted version.
- No additional field commissioning is required for the remote user interface.
- Can be retrofit after unit installation.
- Is fully compatible with the optional BAS communication modules.

**Figure 2, Remote Interface Panel Dimensions**

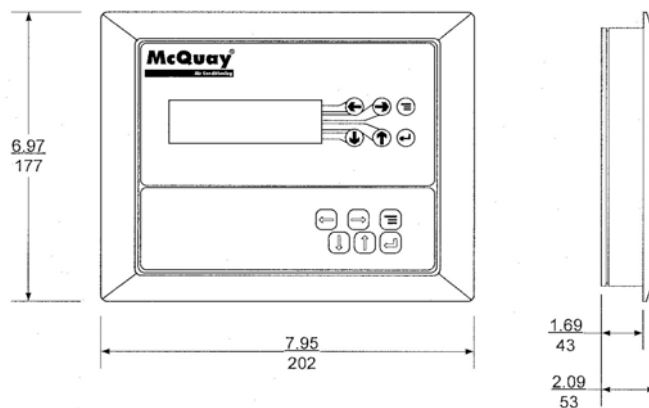

### Cable and Wiring Recommendations

- No more than 1,640 feet (500 meters) of wiring can be used to connect the remote user interface to the unit.
- Power: AWG 22 twisted pair cable.
- Communications: Belden 9841 or equal AWG 22 twisted pair.

See manual *IOM MT II Remote* for wiring and installation information.

# Selection Procedures

---

## 60 Hz - I-P Units

The performance data on the following pages are based on a 10-degree F (5.5-degree C) Delta-T through the evaporator (2.4 gpm/ton). Adjustment factors for other Delta-Ts can be found in Table 4. The minimum leaving chilled water temperature without glycol is 40.0°F (4.4°C). For brine selections refer to Table 2 or Table 3 for ethylene or propylene glycol adjustment factors. Ratings are based on a 0.0001 ft<sup>2</sup> x hr x °F/BTU (0.0176 m<sup>2</sup> x °C/kW) fouling factor in the evaporator and sea level operation. For other fouling factors or elevations refer to Table 4.

For applications outside the catalog ratings contact your local McQuay sales representative.

### Selection Example

Specification: 250 tons

95°F ambient air temperature, 4000 feet elevation

500 gpm, 56°F to 44°F, 0.0001 evaporator fouling factor

1. Use the following formula (for water only) to calculate any missing elements:

$$(\text{gpm} \times \text{Delta-T}) / 24 = \text{tons}$$

2. From Performance Data, IP Units in Table 5, an AGS 270B at the given conditions will produce 267.5 tons with compressor kW input of 307.0 and a unit EER of 10.5. The unit performance at standard conditions must be corrected for both altitude and Delta-T from Table 4.

$$\text{Capacity: } 267.5 \text{ tons} \times 0.986 \text{ (Cap. Correction)} = 263.7 \text{ tons}$$

$$\text{Power: } 307.0 \text{ kW} \times 1.022 \text{ (Power Correction)} = 313.7 \text{ kW}$$

$$\text{EER} = \text{Output} / \text{Input} = 10.5 \times 0.986 / 1.022 = 10.1$$

3. Determine the evaporator pressure drop. Using Figure 3, enter at 500 gpm and follow up to the AGS 270B line intersect. Read horizontally to obtain an evaporator pressure drop of 11.5 ft.

### Selection example utilizing ethylene glycol

Given:

250 tons, 95°F ambient temperature

56°F to 44°F chilled fluid temperature

0.0001 evaporator fouling factor.

Protect against freezing to 0°F

1. From Table 2 select an ethylene glycol concentration of 40% to protect to 0°F.
2. Adjustment factors at 40% glycol from Table 2:

$$\text{Capacity} = 0.943, \quad \text{Power} = 0.973, \quad \text{Flow} = 1.132, \quad \text{Pressure Drop} = 1.664.$$

3. Adjustment Factor for 12 degree chilled water range from Table 4 is 1.000 Capacity and 1.000 Power. The effect of 12-degree Delta-T is negligible. If the correction factor were other than zero, it would be applied to the unit's cataloged performance, in addition to the glycol correction.



- Select an AGS 270B with a capacity of 267.5 tons and correct performance with 40% ethylene glycol factors.

Correct capacity:  $0.943 \times 1.000 \times 267.5 \text{ tons} = 252.3 \text{ tons}$ .

Correct compressor power:  $0.973 \times 1.000 \times 307.0 \text{ kW} = 298.7 \text{ kW}$

- Correct chilled fluid flow:

Fluid flow (water) at 250 tons

$\text{gpm (water)} = (\text{tons} \times 24) / \text{delta-T}$

$\text{gpm} = (250 \text{ tons} \times 24) / 12 \text{ degrees} = 500 \text{ gpm}$

Fluid flow required with 40% EG solution:

$500 \text{ gpm (water)} \times 1.132 \text{ flow correction factor} = 566 \text{ gpm (ethylene glycol)}$

- Determine the evaporator pressure drop. Using Figure 3, enter at 500 gpm (water flow rate, not the glycol flow rate), and follow to the AGS 270B line intersect. Read horizontally to obtain an evaporator pressure drop of 11.5 ft.

- Correct the pressure drop for 40% EG solution:

$11.5 \text{ ft} \times 1.664 \text{ pressure drop correction factor} = 19.1 \text{ ft for ethylene glycol}$ .

## Performance Adjustment Factors

### Ethylene and Propylene Glycol Factors

AGS chiller units are designed to operate with leaving chilled fluid temperatures of 20.0°F to 50.0°F (-6.7°C to 10.0°C). Consult the local McQuay sales office for performance outside these temperatures. Leaving chilled fluid temperatures below 40°F (4.4°C) result in evaporating temperatures at, or below, the freezing point of water and a glycol solution is required. McQuay also recommends double insulation, and the system designer should determine its necessity. The use of glycol will reduce the performance of the unit depending on its concentration. This should be taken into consideration during initial system design. The supplier normally recommends that a minimum of 25% glycol solution by weight be used for protection against corrosion or additional inhibitors should be added.

**Table 2, Ethylene Glycol**

% E.G	Freeze Point		Capacity	Power	Flow	Pressure Drop
	°F	°C				
10	26	-3.3	0.994	0.998	1.036	1.104
20	18	-7.8	0.979	0.990	1.060	1.256
30	7	-13.9	0.964	0.983	1.092	1.424
40	-7	-21.7	0.943	0.973	1.132	1.664
50	-28	-33.3	0.920	0.963	1.182	1.944

**Table 3, Propylene Glycol**

% P.G	Freeze Point		Capacity	Power	Flow	Pressure Drop
	°F	°C				
10	26	-3.3	0.985	0.993	1.017	1.120
20	19	-7.2	0.964	0.983	1.032	1.272
30	9	-12.8	0.932	0.969	1.056	1.496
40	-5	-20.6	0.889	0.948	1.092	1.792
50	-27	-32.8	0.846	0.929	1.139	2.128

## Altitude Correction Factors

Performance tables are based on sea-level altitude. At elevations higher than sea level, the performance of the unit will be decreased due to the lower air density. For performance at elevations other than sea level refer to Table 4.

## Evaporator Temperature Drop Factors

Performance tables are based on a 10-degree F (5.6 degree C) temperature drop through the evaporator. Other delta-Ts will require adjustment factors found in Table 4. Temperature drops outside a 6 to 16 degree F (3.3- to 8.9-degree C) range can adversely affect the system's capability to maintain acceptable control and are not recommended.

The maximum water temperature that can be circulated through the evaporator in a non-operating mode is 100°F (37.8°C). High temperatures can result in poor performance and damage to the equipment.

## Fouling Factor

Performance tables are based on water with a fouling factor of 0.0001 ft<sup>2</sup> x hr x °F/BTU (0.0176 m<sup>2</sup> x °C/kW) per ARI 550/590-98. As fouling is increased, performance decreases. For performance at other fouling factors refer to Table 4.

Foreign matter in the chilled water system will adversely affect the heat transfer capability of the evaporator and could increase the pressure drop and reduce the water flow. For optimum unit operation, proper water treatment and filtration must be maintained.

**Table 4, Correction Factors**

AGS Capacity and Power Multiplier										
Altitude	Chilled Water Delta T		Fouling Factor							
			0.0001 (0.0176)		0.00025 (0.044)		0.00075 (0.132)		0.00175 (0.308)	
	°F	°C	Cap.	Power	Cap.	Power	Cap.	Power	Cap.	Power
Sea Level	7	3.9	1.000	1.000	0.982	0.992	0.927	0.966	0.832	0.923
	8	4.4	1.000	1.000	0.982	0.992	0.927	0.966	0.832	0.923
	10	5.6	1.000	1.000	0.983	0.992	0.927	0.966	0.832	0.923
	12	6.7	1.000	1.000	0.983	0.992	0.927	0.966	0.832	0.923
	14	6.8	1.001	1.000	0.983	0.992	0.927	0.966	0.833	0.924
	16	8.9	1.001	1.001	0.984	0.992	0.928	0.967	0.833	0.924
2000 feet 610 meters	7	3.9	0.993	1.010	0.976	1.002	0.920	0.976	0.826	0.933
	8	4.4	0.993	1.010	0.976	1.002	0.920	0.976	0.826	0.933
	10	5.6	0.993	1.011	0.976	1.002	0.921	0.976	0.827	0.933
	12	6.7	0.994	1.011	0.976	1.002	0.921	0.976	0.827	0.933
	14	6.8	0.994	1.011	0.977	1.003	0.921	0.977	0.827	0.933
	16	8.9	0.995	1.011	0.977	1.003	0.922	0.977	0.828	0.933
4000 feet 1220 meters	7	3.9	0.985	1.022	0.968	1.014	0.913	0.987	0.820	0.944
	8	4.4	0.986	1.022	0.968	1.014	0.913	0.987	0.820	0.944
	10	5.6	0.986	1.022	0.969	1.014	0.914	0.988	0.820	0.944
	12	6.7	0.986	1.022	0.969	1.014	0.914	0.988	0.821	0.944
	14	6.8	0.986	1.023	0.969	1.014	0.914	0.988	0.821	0.944
	16	8.9	0.987	1.023	0.970	1.014	0.915	0.988	0.821	0.944
6000 feet 1830 meters	7	3.9	0.977	1.036	0.960	1.027	0.905	1.001	0.813	0.956
	8	4.4	0.977	1.036	0.960	1.027	0.905	1.001	0.813	0.956
	10	5.6	0.977	1.036	0.960	1.027	0.906	1.001	0.813	0.956
	12	6.7	0.977	1.036	0.960	1.027	0.906	1.001	0.813	0.956
	14	6.8	0.978	1.036	0.961	1.028	0.906	1.001	0.814	0.956
	16	8.9	0.978	1.036	0.961	1.028	0.907	1.001	0.814	0.957

# Performance Data

## IP Units

Table 5, AGS 230B – AGS 340B

AGS Unit Size	Fan Power (kW)	LWT (°F)	Ambient Air Temperature (°F)														
			75			85			95			105			115		
			Unit	PWR	Unit	Unit	PWR	Unit	Unit	PWR	Unit	Unit	PWR	Unit	Unit	PWR	Unit
			Tons	kWi	EER	Tons	kWi	EER	Tons	kWi	EER	Tons	kWi	EER	Tons	kWi	EER
230B	21.6	40	230.4	218.6	12.6	217.4	234.2	11.1	204.1	251.3	9.7	190.6	270.0	8.5	176.8	290.2	7.3
	21.6	42	239.5	223.4	12.9	226.0	239.0	11.3	212.2	256.2	9.9	198.2	274.9	8.7	184.0	295.1	7.5
	21.6	44	248.7	228.3	13.1	234.7	243.9	11.6	<b>220.5</b>	<b>261.1</b>	<b>10.1</b>	206.1	279.8	8.8	191.4	300.1	7.7
	21.6	46	258.1	233.3	13.3	243.7	249.0	11.7	229.0	266.2	10.3	214.1	285.1	9.0	198.9	305.3	7.8
	21.6	48	267.6	238.5	13.5	252.8	254.2	11.9	237.6	271.4	10.5	222.2	290.3	9.2	206.5	310.7	8.0
	21.6	50	277.4	243.9	13.6	262.1	259.6	12.1	246.4	277.0	10.7	230.5	295.7	9.4	214.3	316.1	8.1
250B	25.2	40	254.7	236.9	12.9	240.3	254.5	11.3	225.5	273.7	9.9	210.5	294.8	8.6	195.3	317.6	7.4
	25.2	42	264.7	241.9	13.1	249.8	259.5	11.6	234.6	278.8	10.1	219.1	299.9	8.8	203.4	322.7	7.6
	25.2	44	274.9	246.9	13.4	259.6	264.6	11.8	<b>243.9</b>	<b>284.0</b>	<b>10.3</b>	227.8	305.2	9.0	211.6	328.1	7.7
	25.2	46	285.4	252.2	13.6	269.5	269.9	12.0	253.3	289.3	10.5	236.8	310.6	9.1	220.0	333.5	7.9
	25.2	48	296.0	257.5	13.8	279.7	275.3	12.2	262.9	294.9	10.7	245.9	316.1	9.3	228.5	339.2	8.1
	25.2	50	306.9	263.1	14.0	290.0	280.9	12.4	272.7	300.5	10.9	255.1	321.9	9.5	237.2	344.9	8.3
270B	28.8	40	279.2	255.4	13.1	263.4	274.8	11.5	247.3	296.3	10.0	230.8	319.6	8.7	214.0	345.0	7.4
	28.8	42	290.2	260.4	13.4	273.9	280.1	11.7	257.3	301.5	10.2	240.3	325.1	8.9	222.9	350.4	7.6
	28.8	44	301.5	265.7	13.6	284.7	285.4	12.0	<b>267.5</b>	<b>307.0</b>	<b>10.5</b>	249.9	330.6	9.1	232.0	356.2	7.8
	28.8	46	313.1	271.2	13.9	295.7	290.9	12.2	277.9	312.7	10.7	259.8	336.2	9.3	241.4	361.9	8.0
	28.8	48	324.8	276.7	14.1	306.9	296.5	12.4	288.6	318.4	10.9	269.9	342.0	9.5	250.8	367.8	8.2
	28.8	50	336.8	282.4	14.3	318.3	302.4	12.6	299.4	324.2	11.1	280.1	348.1	9.7	260.5	373.8	8.4
300B	28.8	40	296.2	275.5	12.9	279.2	297.1	11.3	261.9	321.3	9.8	244.2	348.0	8.4	226.2	377.6	7.2
	28.8	42	307.9	281.1	13.1	290.3	302.8	11.5	272.4	327.0	10.0	254.1	353.8	8.6	235.5	383.3	7.4
	28.8	44	319.7	286.8	13.4	301.6	308.6	11.7	<b>283.1</b>	<b>332.9</b>	<b>10.2</b>	264.2	359.7	8.8	245.0	389.2	7.6
	28.8	46	331.9	292.7	13.6	313.2	314.6	11.9	294.1	339.0	10.4	274.6	365.8	9.0	254.8	395.2	7.7
	28.8	48	344.2	298.9	13.8	324.9	320.8	12.2	305.2	345.1	10.6	285.1	372.0	9.2	264.7	401.5	7.9
	28.8	50	356.8	305.1	14.0	336.9	327.1	12.4	316.6	351.6	10.8	295.8	378.5	9.4	274.7	407.9	8.1
320B	28.8	40	315.7	297.0	12.8	297.2	320.7	11.1	278.4	347.6	9.6	259.2	377.5	8.2	239.8	411.1	7.0
	28.8	42	328.1	303.1	13.0	309.0	326.9	11.3	289.5	353.7	9.8	269.7	383.6	8.4	249.6	417.0	7.2
	28.8	44	340.7	309.4	13.2	321.0	333.4	11.6	<b>300.9</b>	<b>360.1</b>	<b>10.0</b>	280.4	390.1	8.6	259.6	423.2	7.4
	28.8	46	353.6	316.1	13.4	333.2	339.9	11.8	312.4	366.6	10.2	291.3	396.6	8.8	269.9	429.8	7.5
	28.8	48	366.7	322.8	13.6	345.7	346.7	12.0	324.2	373.6	10.4	302.4	403.3	9.0	280.2	436.5	7.7
	28.8	50	380.0	329.7	13.8	358.4	353.6	12.2	336.2	380.5	10.6	313.7	410.3	9.2	290.8	443.3	7.9
340B	32.4	40	349.4	330.0	12.7	329.5	353.2	11.2	309.3	378.8	9.8	288.6	406.8	8.5	267.7	437.0	7.4
	32.4	42	363.0	337.2	12.9	342.5	360.4	11.4	321.5	386.2	10.0	300.2	414.1	8.7	278.6	444.4	7.5
	32.4	44	377.0	344.6	13.1	355.8	367.9	11.6	<b>334.1</b>	<b>393.7</b>	<b>10.2</b>	312.1	421.6	8.9	289.7	452.0	7.7
	32.4	46	391.2	352.2	13.3	369.3	375.7	11.8	346.9	401.4	10.4	324.2	429.6	9.1	301.0	459.8	7.9
	32.4	48	405.7	360.0	13.5	383.1	383.6	12.0	360.0	409.3	10.6	336.5	437.6	9.2	312.6	468.1	8.0
	32.4	50	420.5	368.3	13.7	397.1	391.7	12.2	373.3	417.7	10.7	349.0	445.7	9.4	324.3	476.3	8.2

**NOTES:**

1. Rated in accordance with ARI Standard 550/590-1998.
2. Ratings based on HFC-134a, evaporator fouling factor of 0.0001, 10 degree delta-T, evaporator flow of 2.4 gpm/ton and sea level altitude.
3. Interpolation is allowed, extrapolation is not permitted. Consult McQuay for performance outside the cataloged ratings.
4. KW and EER are for the entire unit, including compressors, fan motors and control power.

**Table 6, AGS 370B – AGS 475B**

AGS Unit Size	Fan Power (kW)	LWT (°F)	Ambient Air Temperature (°F)														
			75			85			95			105			115		
			Unit	PWR	Unit	Unit	PWR	Unit	Unit	PWR	Unit	Unit	PWR	Unit	Unit	PWR	Unit
			Tons	kWi	EER	Tons	kWi	EER	Tons	kWi	EER	Tons	kWi	EER	Tons	kWi	EER
370B	36.0	40	376.5	349.7	12.9	355.0	374.8	11.4	333.0	402.4	9.9	310.6	432.7	8.6	287.9	465.5	7.4
	36.0	42	391.4	357.1	13.2	369.1	382.3	11.6	346.4	410.2	10.1	323.3	440.4	8.8	299.8	473.2	7.6
	36.0	44	406.5	364.9	13.4	383.5	390.1	11.8	<b>360.0</b>	<b>418.0</b>	<b>10.3</b>	336.1	448.3	9.0	311.9	481.2	7.8
	36.0	46	422.1	372.8	13.6	398.3	398.2	12.0	374.0	426.1	10.5	349.3	456.5	9.2	324.2	489.4	8.0
	36.0	48	437.9	381.0	13.8	413.3	406.4	12.2	388.2	434.3	10.7	362.7	464.9	9.4	336.8	497.9	8.1
	36.0	50	454.0	389.4	14.0	428.6	414.8	12.4	402.7	442.9	10.9	376.4	473.5	9.5	349.6	506.5	8.3
400B	39.6	40	401.8	368.3	13.1	378.8	395.3	11.5	355.3	425.2	10.0	331.4	457.7	8.7	307.1	493.1	7.5
	39.6	42	417.7	375.9	13.3	393.9	403.2	11.7	369.7	433.1	10.2	345.0	465.8	8.9	319.9	501.1	7.7
	39.6	44	434.0	383.9	13.6	409.4	411.2	11.9	<b>384.3</b>	<b>441.2</b>	<b>10.5</b>	358.8	474.0	9.1	332.9	509.5	7.8
	39.6	46	450.6	392.0	13.8	425.2	419.4	12.2	399.3	449.6	10.7	372.9	482.4	9.3	346.2	518.0	8.0
	39.6	48	467.5	400.4	14.0	441.3	427.9	12.4	414.6	458.1	10.9	387.4	491.0	9.5	359.7	526.8	8.2
	39.6	50	484.8	409.0	14.2	457.8	436.7	12.6	430.2	467.0	11.1	402.0	500.1	9.6	373.5	535.7	8.4
420B	43.2	40	427.3	386.9	13.3	402.8	416.0	11.6	377.8	448.1	10.1	352.3	482.9	8.8	326.5	520.8	7.5
	43.2	42	444.3	394.8	13.5	419.0	424.1	11.9	393.1	456.2	10.3	366.8	491.3	9.0	340.1	529.1	7.7
	43.2	44	461.6	403.0	13.7	435.5	432.3	12.1	<b>408.8</b>	<b>464.5</b>	<b>10.6</b>	381.6	499.7	9.2	354.0	537.9	7.9
	43.2	46	479.4	411.4	14.0	452.4	440.8	12.3	424.8	473.3	10.8	396.8	508.4	9.4	368.2	546.7	8.1
	43.2	48	497.5	419.9	14.2	469.6	449.4	12.5	441.2	482.0	11.0	412.2	517.3	9.6	382.7	555.7	8.3
	43.2	50	515.9	428.6	14.4	487.2	458.5	12.7	457.8	491.0	11.2	427.9	526.7	9.7	397.5	564.9	8.4
440B	43.2	40	447.3	408.6	13.1	421.3	439.9	11.5	394.8	474.5	10.0	367.8	512.6	8.6	340.4	554.5	7.4
	43.2	42	465.1	417.0	13.4	438.2	448.4	11.7	410.7	483.0	10.2	382.8	521.3	8.8	354.5	563.1	7.6
	43.2	44	483.2	425.8	13.6	455.4	457.2	12.0	<b>427.1</b>	<b>491.9</b>	<b>10.4</b>	398.2	530.3	9.0	369.0	572.2	7.7
	43.2	46	501.7	434.8	13.8	473.0	466.2	12.2	443.7	501.1	10.6	413.9	539.4	9.2	383.7	581.4	7.9
	43.2	48	520.6	444.0	14.1	491.0	475.5	12.4	460.7	510.6	10.8	430.0	549.0	9.4	398.7	590.9	8.1
	43.2	50	539.9	453.5	14.3	509.3	485.2	12.6	478.0	520.2	11.0	446.3	558.7	9.6	414.0	600.6	8.3
450B	43.2	40	461.9	427.7	13.0	434.9	461.2	11.3	407.4	498.6	9.8	379.4	540.1	8.4	351.0	586.1	7.2
	43.2	42	480.1	436.5	13.2	452.2	470.1	11.5	423.8	507.5	10.0	394.8	549.0	8.6	365.5	594.9	7.4
	43.2	44	498.6	445.7	13.4	469.8	479.4	11.8	<b>440.5</b>	<b>516.7</b>	<b>10.2</b>	410.6	558.4	8.8	380.3	604.1	7.6
	43.2	46	517.6	455.3	13.6	487.9	488.8	12.0	457.5	526.3	10.4	426.6	567.9	9.0	395.3	613.8	7.7
	43.2	48	537.0	464.9	13.9	506.2	498.6	12.2	474.9	536.3	10.6	443.0	577.7	9.2	410.6	623.5	7.9
	43.2	50	556.6	474.9	14.1	524.9	508.6	12.4	492.6	546.3	10.8	459.7	587.8	9.4	426.2	633.5	8.1
475B	43.2	40	476.5	446.9	12.8	448.6	482.5	11.2	420.1	522.8	9.6	391.1	567.5	8.3	361.7	617.8	7.0
	43.2	42	495.1	456.1	13.0	466.3	491.8	11.4	436.8	532.0	9.9	406.9	576.7	8.5	376.5	626.8	7.2
	43.2	44	514.1	465.7	13.2	484.3	501.6	11.6	<b>453.9</b>	<b>541.6</b>	<b>10.1</b>	423.0	586.5	8.7	391.6	636.1	7.4
	43.2	46	533.6	475.7	13.5	502.8	511.5	11.8	471.3	551.5	10.3	439.4	596.3	8.8	406.9	646.1	7.6
	43.2	48	553.3	485.9	13.7	521.5	521.6	12.0	489.1	562.0	10.4	456.1	606.5	9.0	422.6	656.1	7.7
	43.2	50	573.4	496.3	13.9	540.6	532.1	12.2	507.1	572.5	10.6	473.1	617.3	9.2	438.5	666.5	7.9

**NOTES:**

1. Rated in accordance with ARI Standard 550/590-1998.
2. Ratings based on HFC-134a, evaporator fouling factor of 0.0001, 10 degree delta-T, evaporator flow of 2.4 gpm/ton and sea level altitude.
3. Interpolation is allowed, extrapolation is not permitted. Consult McQuay for performance outside the cataloged ratings.
4. KW and EER are for the entire unit, including compressors, fan motors and control power.

# SI Units

**Table 7, AGS 230B - AGS 340B**

AGS Unit Size	Fan Power (kW)	LWT (°C)	Ambient Air Temperature (°C)														
			25			30			35			40			45		
			Unit kW	PWR kWi	COP	Unit kW	PWR kWi	COP	Unit kW	PWR kWi	COP	Unit kW	PWR kWi	COP	Unit kW	PWR kWi	COP
230B	21.6	5.0	816.9	224.1	3.65	774.9	238.3	3.25	732.1	253.8	2.88	688.6	270.6	2.55	644.4	288.6	2.24
	21.6	6.0	845.4	228.5	3.70	802.2	242.7	3.31	758.1	258.2	2.94	713.2	275.0	2.60	667.7	293.1	2.28
	21.6	7.0	874.5	232.9	3.76	829.9	247.1	3.36	784.5	262.7	2.99	738.3	279.5	2.64	691.4	297.6	2.33
	21.6	8.0	904.1	237.5	3.81	858.2	251.8	3.41	811.4	267.3	3.04	763.8	284.3	2.69	715.5	302.3	2.37
	21.6	9.0	934.2	242.2	3.86	886.9	256.5	3.46	838.8	272.0	3.08	789.8	289.0	2.74	740.0	307.2	2.41
	21.6	10.0	964.8	247.0	3.91	916.1	261.3	3.51	866.6	277.0	3.13	816.1	293.9	2.78	765.0	312.1	2.45
250B	25.2	5.0	902.9	242.9	3.72	856.5	258.9	3.31	809.1	276.3	2.93	760.9	295.2	2.58	711.9	315.6	2.26
	25.2	6.0	934.6	247.4	3.78	886.8	263.5	3.37	838.1	280.9	2.98	788.4	299.9	2.63	737.9	320.3	2.31
	25.2	7.0	967.0	252.1	3.84	917.7	268.1	3.43	867.6	285.6	3.04	816.4	304.7	2.68	764.5	325.2	2.36
	25.2	8.0	999.9	256.8	3.90	949.3	272.9	3.48	897.6	290.4	3.09	845.0	309.6	2.73	791.5	330.1	2.40
	25.2	9.0	1033.4	261.6	3.95	981.3	277.8	3.53	928.1	295.4	3.14	874.0	314.6	2.78	818.9	335.2	2.45
	25.2	10.0	1067.4	266.6	4.01	1013.8	282.8	3.59	959.2	300.5	3.19	903.5	319.7	2.83	846.9	340.3	2.49
270B	28.8	5.0	990.0	261.8	3.79	939.1	279.6	3.36	887.2	298.9	2.97	834.2	320.0	2.61	780.4	342.7	2.28
	28.8	6.0	1025.0	266.5	3.85	972.6	284.4	3.42	919.2	303.7	3.03	864.6	324.9	2.66	809.2	347.6	2.33
	28.8	7.0	1060.6	271.3	3.92	1006.7	289.2	3.48	951.7	308.7	3.08	895.6	329.9	2.72	838.6	352.8	2.38
	28.8	8.0	1096.9	276.2	3.98	1041.5	294.2	3.54	984.9	313.8	3.14	927.2	335.0	2.77	868.5	357.9	2.43
	28.8	9.0	1133.9	281.2	4.04	1076.9	299.3	3.60	1018.7	319.0	3.19	959.3	340.3	2.82	898.9	363.2	2.48
	28.8	10.0	1171.4	286.4	4.10	1112.8	304.6	3.66	1053.0	324.2	3.25	991.9	345.7	2.87	929.8	368.7	2.53
300B	28.8	5.0	1050.0	282.6	3.72	995.2	302.4	3.29	939.4	324.2	2.90	882.4	348.2	2.54	824.7	374.5	2.21
	28.8	6.0	1086.9	287.7	3.78	1030.5	307.6	3.35	973.0	329.4	2.95	914.4	353.5	2.59	854.9	379.7	2.26
	28.8	7.0	1124.4	293.0	3.84	1066.4	312.8	3.41	1007.2	334.7	3.01	946.9	358.9	2.64	885.6	385.1	2.30
	28.8	8.0	1162.6	298.3	3.90	1102.9	318.3	3.47	1042.0	340.2	3.06	979.9	364.3	2.69	916.9	390.6	2.35
	28.8	9.0	1201.4	303.9	3.96	1140.0	323.8	3.52	1077.4	345.8	3.12	1013.5	370.0	2.74	948.7	396.3	2.40
	28.8	10.0	1240.9	309.5	4.01	1177.8	329.6	3.58	1113.4	351.6	3.17	1047.7	375.8	2.79	981.0	402.0	2.44
320B	28.8	5.0	1118.7	304.8	3.68	1059.2	326.5	3.25	998.6	350.7	2.85	936.9	377.5	2.48	874.5	407.3	2.15
	28.8	6.0	1157.9	310.4	3.74	1096.5	332.1	3.30	1034.1	356.3	2.90	970.6	383.2	2.54	906.2	412.8	2.20
	28.8	7.0	1197.7	316.2	3.79	1134.5	338.0	3.36	1070.3	362.0	2.96	1004.9	389.0	2.59	938.6	418.6	2.25
	28.8	8.0	1238.2	322.2	3.85	1173.2	343.9	3.41	1107.1	368.0	3.01	1039.7	394.9	2.64	971.5	424.5	2.29
	28.8	9.0	1279.4	328.2	3.90	1212.5	350.0	3.47	1144.4	374.3	3.06	1075.1	401.0	2.68	1004.9	430.5	2.34
	28.8	10.0	1321.3	334.5	3.96	1252.5	356.3	3.52	1182.4	380.5	3.11	1111.1	407.3	2.73	1038.8	436.7	2.38
340B	32.4	5.0	1238.5	338.3	3.67	1174.4	359.4	3.27	1109.2	382.5	2.90	1042.8	407.6	2.56	975.6	434.7	2.25
	32.4	6.0	1281.7	344.8	3.72	1215.7	366.0	3.32	1148.5	389.2	2.95	1080.1	414.3	2.61	1010.8	441.4	2.29
	32.4	7.0	1325.7	351.5	3.78	1257.7	372.8	3.38	1188.5	396.0	3.00	1118.1	421.2	2.66	1046.7	448.3	2.34
	32.4	8.0	1370.6	358.5	3.83	1300.5	379.9	3.43	1229.3	403.0	3.05	1156.7	428.4	2.70	1083.2	455.4	2.38
	32.4	9.0	1416.1	365.6	3.88	1344.0	387.0	3.48	1270.7	410.1	3.10	1196.0	435.6	2.75	1120.2	462.8	2.42
	32.4	10.0	1462.5	373.0	3.93	1388.3	394.3	3.52	1312.7	417.7	3.14	1235.9	442.9	2.79	1157.9	470.2	2.47

**NOTES:**

1. Rated in accordance with ARI Standard 550/590-1998.
2. Ratings based on HFC 134a, evaporator fouling factor of 0.0176, 5.6°C degree delta-T, and sea level altitude.
3. Interpolation is allowed, extrapolation is not permitted. Consult McQuay for performance outside the cataloged ratings.
4. KW and COP are for the entire unit, including compressors, fan motors and control power.



**Table 8, AGS 370B - AGS 475B**

AGS Unit Size	Fan Power (kW)	LWT (°C)	Ambient Air Temperature (°C)														
			25			30			35			40			45		
			Unit	PWR	Unit	Unit	PWR	Unit	Unit	PWR	Unit	Unit	PWR	Unit	Unit	PWR	Unit
			kW	kWi	COP	kW	kWi	COP	kW	kWi	COP	kW	kWi	COP	kW	kWi	COP
370B	36.0	5.0	1334.9	358.4	3.73	1265.4	381.3	3.32	1194.6	406.3	2.94	1122.6	433.5	2.59	1049.7	462.8	2.27
	36.0	6.0	1381.9	365.3	3.79	1310.3	388.2	3.38	1237.4	413.3	2.99	1163.2	440.5	2.64	1088.0	469.8	2.32
	36.0	7.0	1429.8	372.3	3.85	1356.0	395.3	3.43	1280.9	420.4	3.05	1204.5	447.7	2.69	1127.1	477.1	2.37
	36.0	8.0	1478.6	379.5	3.90	1402.6	402.6	3.49	1325.3	427.7	3.10	1246.6	455.2	2.74	1166.9	484.5	2.41
	36.0	9.0	1528.2	386.9	3.95	1450.0	410.0	3.54	1370.4	435.2	3.15	1289.4	462.7	2.79	1207.3	492.2	2.46
	36.0	10.0	1578.7	394.5	4.01	1498.2	417.7	3.59	1416.3	442.9	3.20	1332.9	470.4	2.84	1248.3	499.9	2.50
400B	39.6	5.0	1424.6	377.5	3.78	1350.4	402.3	3.36	1274.8	429.2	2.97	1197.9	458.5	2.61	1119.9	490.0	2.29
	39.6	6.0	1475.0	384.6	3.84	1398.5	409.4	3.42	1320.7	436.4	3.03	1241.4	465.8	2.67	1161.1	497.4	2.34
	39.6	7.0	1526.3	391.8	3.90	1447.6	416.7	3.48	1367.4	443.7	3.08	1285.8	473.2	2.72	1203.1	505.0	2.39
	39.6	8.0	1578.6	399.2	3.96	1497.6	424.1	3.53	1415.1	451.3	3.14	1331.1	480.9	2.77	1245.8	512.6	2.43
	39.6	9.0	1631.8	406.8	4.02	1548.5	431.8	3.59	1463.5	459.0	3.19	1377.0	488.7	2.82	1289.3	520.5	2.48
	39.6	10.0	1686.0	414.5	4.07	1600.2	439.7	3.64	1512.8	467.0	3.24	1423.8	496.7	2.87	1333.5	528.6	2.53
420B	43.2	5.0	1515.1	396.7	3.82	1436.1	423.3	3.40	1355.6	452.1	3.00	1273.7	483.6	2.64	1190.6	517.4	2.31
	43.2	6.0	1568.8	404.0	3.89	1487.5	430.6	3.46	1404.7	459.5	3.06	1320.3	491.2	2.69	1234.7	525.0	2.36
	43.2	7.0	1623.6	411.4	3.95	1539.9	438.1	3.52	1454.6	467.1	3.11	1367.8	498.8	2.74	1279.6	532.9	2.41
	43.2	8.0	1679.5	418.9	4.01	1593.4	445.7	3.58	1505.6	475.0	3.17	1416.1	506.7	2.80	1325.4	540.8	2.45
	43.2	9.0	1736.3	426.7	4.07	1647.7	453.6	3.64	1557.4	482.9	3.22	1465.3	514.7	2.85	1371.9	548.9	2.50
	43.2	10.0	1794.1	434.6	4.13	1702.9	461.8	3.69	1610.0	491.0	3.28	1515.4	523.1	2.90	1419.3	557.3	2.55
440B	43.2	5.0	1585.7	419.1	3.79	1501.8	447.6	3.36	1416.4	478.7	2.96	1329.5	513.1	2.59	1241.5	550.4	2.26
	43.2	6.0	1641.9	426.8	3.85	1555.4	455.4	3.42	1467.4	486.6	3.02	1377.9	521.0	2.65	1287.3	558.3	2.31
	43.2	7.0	1699.1	434.8	3.91	1610.1	463.4	3.48	1519.5	494.7	3.07	1427.3	529.2	2.70	1333.9	566.5	2.36
	43.2	8.0	1757.5	442.9	3.97	1665.8	471.6	3.54	1572.5	503.0	3.13	1477.6	537.5	2.75	1381.4	574.9	2.41
	43.2	9.0	1816.8	451.3	4.03	1722.4	480.0	3.59	1626.4	511.6	3.18	1528.7	546.1	2.80	1429.7	583.5	2.45
	43.2	10.0	1877.2	459.8	4.09	1780.0	488.7	3.65	1681.2	520.2	3.23	1580.6	554.9	2.85	1478.7	592.2	2.50
450B	43.2	5.0	1637.0	438.8	3.74	1550.0	469.4	3.31	1461.5	503.1	2.90	1371.4	540.4	2.54	1280.2	581.3	2.21
	43.2	6.0	1694.6	446.9	3.80	1605.0	477.5	3.36	1513.8	511.2	2.96	1421.0	548.6	2.59	1327.0	589.4	2.26
	43.2	7.0	1753.2	455.3	3.86	1660.9	485.9	3.42	1567.0	519.6	3.02	1471.5	557.1	2.64	1374.7	597.9	2.30
	43.2	8.0	1812.9	463.9	3.91	1717.9	494.5	3.48	1621.2	528.3	3.07	1522.9	565.7	2.69	1423.2	606.5	2.35
	43.2	9.0	1873.6	472.7	3.97	1775.8	503.4	3.53	1676.3	537.3	3.12	1575.0	574.6	2.74	1472.5	615.3	2.40
	43.2	10.0	1935.3	481.6	4.02	1834.7	512.4	3.58	1732.3	546.3	3.17	1628.1	583.7	2.79	1522.5	624.4	2.44
475B	43.2	5.0	1688.5	458.7	3.69	1598.4	491.2	3.26	1506.7	527.4	2.86	1413.5	567.7	2.49	1319.0	612.3	2.16
	43.2	6.0	1747.4	467.1	3.75	1654.7	499.7	3.31	1560.2	535.9	2.91	1464.2	576.2	2.54	1366.9	620.5	2.21
	43.2	7.0	1807.4	475.9	3.80	1711.9	508.6	3.37	1614.7	544.6	2.96	1515.8	585.0	2.59	1415.6	629.2	2.25
	43.2	8.0	1868.5	484.9	3.86	1770.2	517.5	3.42	1670.1	553.6	3.02	1568.3	593.9	2.64	1465.1	638.2	2.30
	43.2	9.0	1930.6	494.1	3.91	1829.4	526.7	3.48	1726.3	563.0	3.07	1621.5	603.1	2.69	1515.4	647.3	2.35
	43.2	10.0	1993.6	503.5	3.97	1889.5	536.1	3.53	1783.5	572.5	3.12	1675.6	612.8	2.74	1566.4	656.7	2.39

**NOTES:**

1. Rated in accordance with ARI Standard 550/590-1998.
2. Ratings based on HFC 134a, evaporator fouling factor of 0.0176, 5.6°C degree delta-T, and sea level altitude.
3. Interpolation is allowed, extrapolation is not permitted. Consult McQuay for performance outside the cataloged ratings.
4. KW and COP are for the entire unit, including compressors, fan motors and control power.

# Part Load Data

**Table 9, AGS 230B – AGS 475B**

Unit Size	% Load	Capacity Tons	Power Unit kW	EER	IPLV
230B	100.00	220.6	261.1	10.1	13.0
	75.00	165.4	171.1	11.6	
	50.00	110.3	90.7	14.6	
	25.00	55.1	54.2	12.2	
250B	100.00	243.8	284.0	10.3	13.1
	75.00	182.9	179.6	12.2	
	50.00	121.9	102.7	14.2	
	25.00	61.0	62.0	11.8	
270B	100.00	267.5	307.0	10.5	13.7
	75.00	200.6	183.2	13.1	
	50.00	133.7	110.2	14.6	
	25.00	66.9	62.6	12.8	
300B	100.00	283.1	332.9	10.2	13.7
	75.00	212.4	199.4	12.8	
	50.00	141.6	114.8	14.8	
	25.00	70.8	65.6	12.9	
320B	100.00	300.9	360.1	10.0	13.1
	75.00	225.7	217.6	12.4	
	50.00	150.4	127.9	14.1	
	25.00	75.2	74.2	12.2	
340B	100.00	334.1	393.7	10.2	13.0
	75.00	250.6	238.2	12.6	
	50.00	167.1	150.8	13.3	
	25.00	83.5	76.7	13.1	

Unit Size	% Load	Capacity Tons	Power Unit kW	EER	IPLV
370B	100.00	360.0	418.0	10.3	13.0
	75.00	270.0	257.1	12.6	
	50.00	180.0	161.0	13.4	
	25.00	90.0	81.8	13.2	
400B	100.00	384.3	441.2	10.5	13.4
	75.00	288.3	274.6	12.6	
	50.00	192.2	162.4	14.2	
	25.00	96.1	87.4	13.2	
420B	100.00	408.8	464.5	10.6	14.0
	75.00	306.6	294.7	12.5	
	50.00	204.4	164.0	15.0	
	25.00	102.2	77.4	15.9	
440B	100.00	427.1	491.9	10.4	13.9
	75.00	320.3	309.8	12.4	
	50.00	213.5	172.0	14.9	
	25.00	106.8	80.3	16.0	
450B	100.00	440.5	516.7	10.2	13.6
	75.00	330.4	324.9	12.2	
	50.00	220.2	182.6	14.5	
	25.00	110.1	83.1	15.9	
475B	100.00	453.9	541.6	10.1	13.3
	75.00	340.4	339.7	12.0	
	50.00	226.9	193.3	14.1	
	25.00	113.5	91.9	14.8	

**NOTE:** Rated in accordance with the ARI Water-Chilling Packages Using the Vapor Compression Cycle Certification Program, which is based on ARI Standard 550/590-1998.

# Pressure Drop

Figure 3, Evaporator Pressure Drop, AGS 230B - AGS 475B

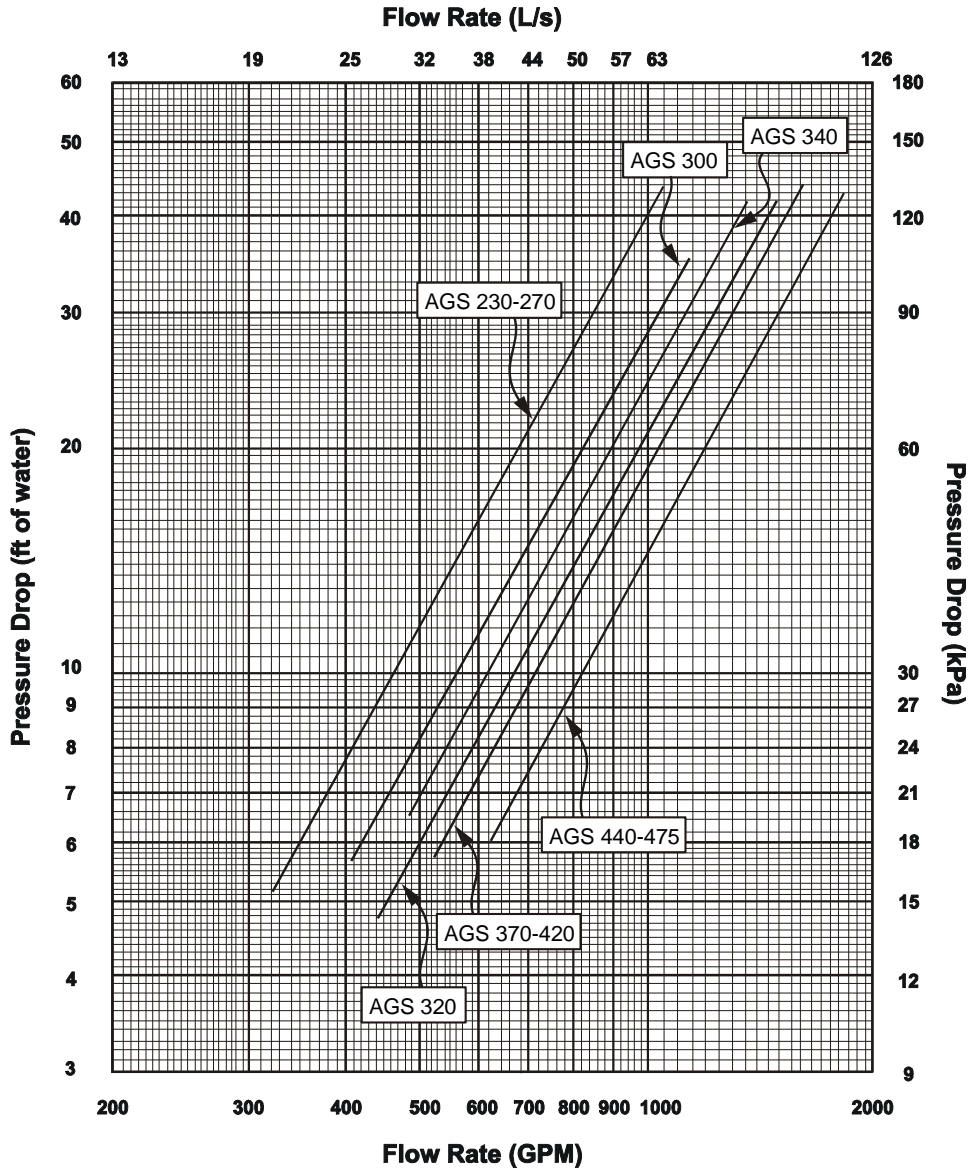

Minimum/Nominal/Maximum Flow Rates

AGS Unit Size	Minimum Flow		Nominal Flow		Maximum	
	Flow	$\Delta P$	Flow	$\Delta P$	Flow	$\Delta P$
	gpm	ft.	gpm	ft.	gpm	ft.
230B	330	5.3	529	12.8	882	32.0
250B	365	6.5	585	15.3	975	37.5
270B	401	7.8	642	18.2	1070	44.0
300B	424	6.1	679	14.2	1132	35.2
320B	451	4.9	722	11.5	1203	39.0
340B	501	7.0	801	16.0	1336	42.0
370B	540	6.1	864	14.4	1440	36.0
400B	576	6.8	922	16.0	1537	40.0
420B	613	7.5	981	18.2	1635	44.0
440B	640	6.4	1025	15.2	1708	38.0
450B	660	6.7	1057	16.4	1762	41.0
475B	680	7.1	1089	17.0	1815	43.0

# Sound Data

---

Sound levels can be as important as unit cost and efficiency, and must be addressed before the start of any project design. Efforts by McQuay design engineers to design chillers that are sensitive to the sound requirements of the market, combined with McQuay's inherently quiet rotary screw compressors, have paid off.

## Standards

ARI has established standards to provide uniform methods for the determination of the sound levels of equipment. For large air-cooled chillers it is ARI Standard 370, *Sound Ratings of Large Outdoor Refrigeration and Air-Conditioning Equipment*.

## Background Information

Sound is a vibration in an elastic medium and is essentially a pressure and particle displacement phenomena. A vibrating body produces compression waves and as the waves are emitted from the vibrating body, molecules are ultimately compressed. These values are transmitted through gases, liquids or solids—anything that is elastic or viscous.

The sound data provided in this section is presented with both sound pressure and sound power levels. Sound power is the total sound energy radiated by a source per unit of time integrated over the surface through which the sound is radiated. Sound power is a calculated quantity and cannot be measured directly like sound pressure. Sound power is not dependent on the surrounding environment or distance from the source.

Sound pressure varies with the distance from the source and is dependent on its surroundings. For example, a brick wall located 10 feet from a unit (two reflecting surfaces, the roof and the wall) will affect the sound pressure measurements differently than a unit mounted on a roof with only one reflecting surface (the roof). Sound pressure is measured in decibels (dB), which is a dimensionless ratio (on a logarithmic scale) between measured sound pressure and a reference sound pressure level.

## Sound Pressure Levels - Full Load

All sound pressure tables give the overall "A" weighted sound pressure levels which are considered typical of what can be measured in a hemispherical field with a hand held sound meter in the absence of any nearby reflective surfaces other than the ground itself. The sound pressure in Table 10 measured at 30 feet from the side of the unit, at 100% unit load, no reflecting walls ( $Q=2$ ), and ARI conditions; 95°F (35°C) ambient air temperature and 54/44°F (12/7°C) chilled water temperatures.

## Sound Power Levels

Acoustical consultants can require sound power octave band data to perform a detailed acoustical analysis. Sound measurements are taken over a prescribed area around the unit and the data is mathematically calculated to give the sound power in dB.

**Table 10, Sound Pressure Octave Band Data, 60 Hz**

Unit Model	Octave Band & Center Frequency, Hz.								Overall A-Weighted
	63	125	250	500	1000	2000	4000	8000	
230B	70	73	71	69	69	66	58	51	73
250B	71	74	71	70	70	67	59	52	74
270B	70	72	69	69	70	66	57	50	74
300B	70	72	69	69	70	66	57	50	74
320B	70	72	69	69	70	66	57	50	74
340B	72	75	72	71	72	68	59	53	76
370B	73	74	73	70	70	67	60	54	75
400B	74	75	74	71	71	69	62	56	76
420B	74	75	74	71	71	69	62	56	76
440B	74	75	74	71	71	69	62	56	76
450B	74	75	74	71	71	69	62	56	76
475B	76	76	75	72	72	70	63	57	77

Note: Data at:  
 r=30 ft., .sound pressure at 30 feet (9.1 meters) from unit  
 Q=2, unit on a flat roof or ground with no adjacent wall(s).

**Table 11, Sound Power Octave Band Data, 60 Hz**

Unit Model	Octave Band & Center Frequency, Hz.								Overall A-Weighted
	63	125	250	500	1000	2000	4000	8000	
230B	97	100	98	96	96	93	85	78	100
250B	98	101	98	97	97	94	86	79	101
270B	97	99	96	96	97	93	84	77	101
300B	97	99	96	96	97	93	84	77	101
320B	97	99	96	96	97	93	84	77	101
340B	99	102	99	98	99	95	86	80	103
370B	100	101	100	97	97	94	87	81	102
400B	100	102	100	98	98	96	89	83	103
420B	100	102	101	98	98	96	89	83	103
440B	100	102	101	98	98	96	89	83	103
450B	100	102	101	98	98	96	89	83	103
475B	103	103	102	99	99	97	90	84	104

Note: Sound power octave band data, dB per ARI Standard 370.

### Sound Reduction Due to Distance from a Unit

The distance between a source of sound and the location of the sound measurement plays an important role in minimizing sound problems. The equation below can be used to calculate the *sound pressure level* at any distance if the *sound power* is known. Results for typical distances are tabulated in Table 12. Another way of determining the effect of distance is to work from sound pressure only. “Q”, the directionality factor, is a dimensionless number that compensates for the type of sound reflection from the source. For example, a unit sitting on a flat roof or ground with no other reflective surfaces or attenuation due to grass, snow, etc., between source and receiver: Q=2.

**Figure 4, "Q" Definition, Plan View, Unit Located in Center**

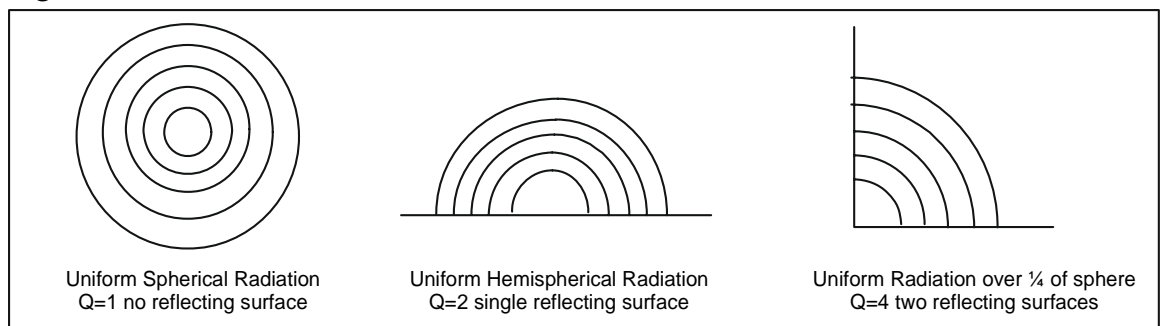



Sound pressure can be calculated at any distance from the unit if the sound power is known.

$$L_p = L_w - (20 \log r) + (10 \log Q) - .5$$

$L_p$  = sound pressure

$r$  = distance from unit in feet

$L_w$  = sound power

$Q$  = directionality factor

With  $Q=1$ , Unit suspended in space (theoretical condition), the equation simplifies to:

$$L_p = L_w - (20)(\log r) - 0.5$$

With  $Q=2$ , for a unit sitting on a flat roof or ground with no adjacent vertical wall as a reflective surface, the equation simplifies to:

$$L_p = L_w - (20)(\log r) + 2.5$$

With  $Q=4$  for a unit sitting on a flat roof or ground with one adjacent vertical wall as a reflective surface, the equation simplifies to:

$$L_p = L_w - (20)(\log r) + 5.5$$

The equations are reduced to table form in Table 12 for various distances and the two most usual cases of “Q” type of location.

**Table 12, dB Conversion of Sound Power to Pressure for Distance**

Distance from Sound Source ft. (m)	dB Reduction from Sound Power at the Source to Sound Pressure at Referenced Distance	
	Q=2	Q=4
30 (9)	27.1	24.0
50 (15)	31.6	28.5
75 (23)	35.1	32.0
100 (30)	37.6	34.5
150 (46)	41.1	38.0
200 (61)	43.6	40.5
300 (91)	47.6	44.0

Figure 5 gives the reduction in *sound pressure* due to distance.

**Figure 5, Sound Pressure Attenuation Due to Distance from Unit**

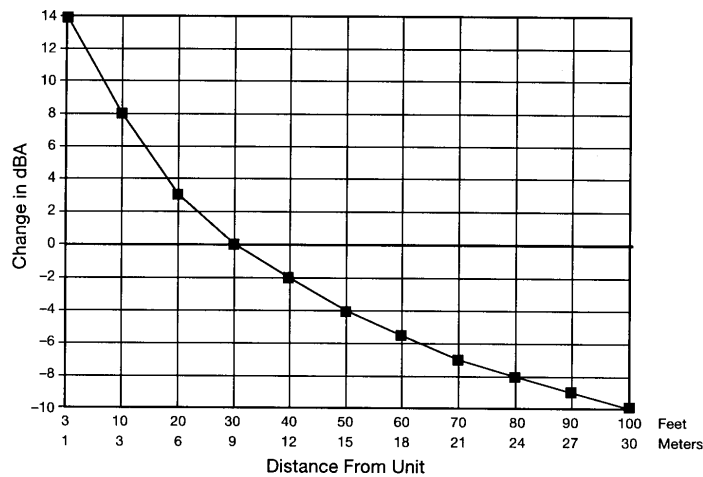

## Sound Reduction

The low sound level for the AGS screw chiller satisfies most customer requirements. However, there can be applications where even lower sound levels can be required. The most effective isolation method is to locate the unit away from sound sensitive areas. Avoid locations beneath windows or between structures where normal-operating sounds can be objectionable. Isolating water lines, electrical conduit and the unit itself can reduce structurally transmitted sound. Wall sleeves and rubber isolated piping hangers can be used to reduce transmission of water or pump noise into occupied spaces, and flexible electrical connections can be used to isolate sound through electrical conduit. Spring isolators are effective in reducing the low amplitude sound generated by screw compressors and can be used for unit isolation in sound sensitive areas.

McQuay offers sound isolation for the oil separators and discharge lines as an option. The unit sound level is reduced by the dBA values shown below.

AGS Model	230	250	270	300	320	340	370	400	420	440	450	475
Power "A"	-2.5	-2.7	-3.2	-3.2	-3.2	-2.7	-3.1	-2.7	-3.1	-3.1	-3.1	-3.1
Pressure "A"	-2.7	-2.8	-3.2	-3.2	-3.2	-2.7	-3.1	-2.7	-3.1	-3.1	-3.1	-3.1

## Sound Pressure Levels, Low Ambient Operation

Unit operation at a lower ambient temperature than 95°F will also result in lower sound pressure levels. The sound pressure level will decrease approximately 1 dBA for ambient air temperatures between 85°F and 94°F, approximately 2 dBA for ambient air temperatures between 75°F and 84°F, and approximately 3 dBA for ambient air temperatures between 65°F and 74°F.

## Sound Pressure Levels, Multiple Units

Multiple air-cooled unit installations will have a higher sound level than a single unit. Two units will have approximately 3 dB higher sound level of one unit, 4 units will be approximately 6 dB louder, and 8 units approximately 9 dB louder than one unit.

## Sound Control

Walls adjacent to a unit (20 feet {6.1 meters} or less) will reflect sound outwards, increasing the sound pressure on the side away from the wall. This sound increase could be as high as 3 dB for one wall and as high as 6 dB for a corner

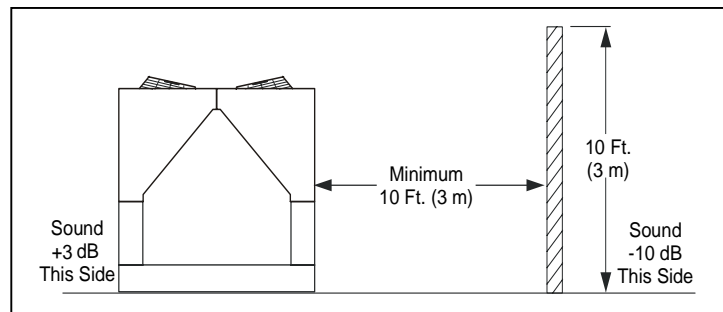

location. Unit orientation and/or distance as noted above will decrease sound levels.

Sound levels can also be controlled by the installation of barrier walls. To be effective as sound blockers, walls must be solid with no open penetrations. Sound tends to leak out of openings. Block walls with filler material and slots on the side facing the unit are especially effective. The wall should be about 10 feet high (two feet higher than the unit) and located at least 10 feet away so as not to affect unit performance. A three-sided enclosure will be the most effective solution and will reduce sound levels by about 10 dB. Remember that the sound blocker wall will *increase* the sound level on the side of the unit opposite it by 3 to 6 dB (one or three sided wall).

**Note:** The effect of adjacent walls on air recirculation and restriction must always be considered when employing sound barrier walls.

# Electrical Data

**Table 13, AGS 230B – AGS 475B, Electrical Data, Optional Single-Point**

AGS UNIT SIZE	VOLTS	HZ	MINIMUM CIRCUIT AMPACITY (MCA)	POWER SUPPLY				FIELD FUSE SIZE or HACR BREAKER SIZE	
				FIELD WIRE		HUB (Conduit Connection)		RECOMMENDED	MAXIMUM
				QTY	WIRE GAUGE	QTY	NOMINAL SIZE (In.)		
230	460	60	475	6	250	2	2.5	600	600
	575		418	6	4/0	2	2.0	500	500
250	460	60	519	6	300	2	3.0	600	700
	575		447	6	4/0	2	2.0	500	600
270	460	60	555	6	300	2	3.0	700	700
	575		471	6	250	2	2.5	600	600
300	460	60	586	6	350	2	3.0	700	800
	575		496	6	250	2	2.5	600	700
320	460	60	611	6	350	2	3.0	700	800
	575		516	6	300	2	3.0	600	700
340	460	60	688	12	4/0	2	3.0	800	800
	575		605	12	3/0	2	3.0	700	700
370	460	60	732	12	250	2	4.0	800	800
	575		634	12	3/0	2	3.0	700	800
400	460	60	768	12	250	2	4.0	800	800
	575		658	12	4/0	2	3.0	800	800
420	460	60	804	12	250	2	4.0	1000	1000
	575		683	12	4/0	2	3.0	800	800
440	460	60	835	12	300	2	4.0	1000	1000
	575		708	12	4/0	2	3.0	800	800
450	460	60	860	12	300	2	4.0	1000	1000
	575		728	12	4/0	2	3.0	800	800
475	460	60	885	12	300	2	4.0	1000	1000
	575		748	12	250	2	4.0	800	800

**NOTES**

1. Table based on 75°C field wire.
2. A "HACR" breaker is a circuit breaker designed for use on equipment with multiple motors. It stands for Heating, Air Conditioning, and Refrigeration.
3. Complete notes are on page 30.

**Table 14, AGS 230B – AGS 320B, Electrical Data, Standard Multiple-Point, Two-Circuit Units**

AGS UNIT SIZE	VOLTS	HZ	ELECTRICAL CIRCUIT 1 (COMP 1)							ELECTRICAL CIRCUIT 2 (COMP 2)								
			MINIMUM CIRCUIT AMPS (MCA)	POWER SUPPLY			FIELD FUSING				MINIMUM CIRCUIT AMPS (MCA)	POWER SUPPLY			FIELD FUSING			
				FIELD WIRE		HUB (Conduit Connection)		REC FUSE SIZE	MAX FUSE SIZE	FIELD WIRE		HUB (Conduit Connection)		REC FUSE SIZE	MAX FUSE SIZE			
				QTY	WIRE GAUGE	QTY	HUB SIZE			QTY		WIRE GAUGE	QTY			HUB SIZE		
230	460	60	262	6	3/0 (3)	1	3.0	350	450	262	6	3/0 (3)	1	3.0	350	450		
	575		230	3	250	1	2.5	300	400	230	3	250	1	2.5	300	400		
250	460	60	262	6	3/0 (3)	1	3.0	350	450	306	6	3/0	1	3.0	400	500		
	575		230	3	250	1	2.5	300	400	260	6	3/0 (3)	1	3.0	350	400		
270	460	60	306	6	3/0	1	3.0	400	500	306	6	3/0	1	3.0	400	500		
	575		260	6	3/0 (3)	1	3.0	350	400	260	6	3/0 (3)	1	3.0	350	400		
300	460	60	306	6	3/0	1	3.0	400	500	337	6	4/0	1	3.0	450	500		
	575		260	6	3/0 (3)	1	3.0	350	400	285	6	3/0	1	3.0	350	450		
320	460	60	337	6	4/0	1	3.0	450	500	337	6	4/0	1	3.0	450	500		
	575		285	6	3/0	1	3.0	350	450	285	6	3/0	1	3.0	350	450		

**NOTES:**

1. Table based on 75°C field wire.
2. Complete notes are on page 30.
3. 3/0 wire is required for the disconnect switch option, 2/0 may be used for power block connection.

**Table 15, AGS 340B–AGS 475B, Electrical Data, Standard Multiple-Point, (Circuits # 1 & 2)**

AGS UNIT SIZE	VOLTS	HZ	ELECTRICAL CIRCUIT 1 (COMP 1)							ELECTRICAL CIRCUIT 2 (COMP 2)							
			MINIMUM CIRCUIT AMPS (MCA)	POWER SUPPLY				FIELD FUSING			MIN. CIRCUIT AMPS (MCA)	POWER SUPPLY				FIELD FUSING	
				FIELD WIRE		HUB (Conduit Connection)		REC FUSE SIZE	MAX FUSE SIZE	FIELD WIRE		HUB (Conduit Connection)		REC FUSE SIZE	MAX FUSE SIZE		
				QTY	WIRE GAUGE	QTY	HUB SIZE			QTY		WIRE GAUGE	QTY			HUB SIZE	
340	460	60	262	6	3/0 (3)	1	3.0	350	450	262	6	3/0 (3)	1	3.0	350	450	
	575		230	3	250	1	2.5	300	400	230	3	250	1	2.5	300	400	
370	460	60	262	6	3/0 (3)	1	3.0	350	450	262	6	3/0 (3)	1	3.0	350	450	
	575		230	3	250	1	2.5	300	400	230	3	250	1	2.5	300	400	
400	460	60	262	6	3/0 (3)	1	3.0	350	450	306	6	3/0	1	3.0	400	500	
	575		230	3	250	1	2.5	300	400	260	6	3/0 (3)	1	3.0	350	400	
420	460	60	306	6	3/0	1	3.0	400	500	306	6	3/0	1	3.0	400	500	
	575		260	6	3/0 (3)	1	3.0	350	400	260	6	3/0 (3)	1	3.0	350	400	
440	460	60	306	6	3/0	1	3.0	400	500	306	6	3/0	1	3.0	400	500	
	575		260	6	3/0 (3)	1	3.0	350	400	260	6	3/0 (3)	1	3.0	350	400	
450	460	60	306	6	3/0	1	3.0	400	500	337	6	4/0	1	3.0	450	500	
	575		260	6	3/0 (3)	1	3.0	350	400	285	6	3/0	1	3.0	350	450	
475	460	60	337	6	4/0	1	3.0	450	500	337	6	4/0	1	3.0	450	500	
	575		285	6	3/0	1	3.0	350	450	285	6	3/0	1	3.0	350	450	

**NOTES:**

1. Table based on 75°C field wire.
2. Complete notes are on page 30.
3. 3/0 wire is required for the disconnect switch option, 2/0 may be used for power block connection.

**(Circuit #3)**

AGS UNIT SIZE	VOLTS	HZ	ELECTRICAL CIRCUIT 3 (COMP 3)						
			MINIMUM CIRCUIT AMPS (MCA)	POWER SUPPLY				FIELD FUSING	
				FIELD WIRE		HUB (Conduit Connection)		REC FUSE SIZE	MAX FUSE SIZE
				QTY	WIRE GAUGE	QTY	HUB SIZE		
340	460	60	262	6	3/0 (3)	1	3.0	350	450
	575		230	3	250	1	2.5	300	400
370	460	60	306	6	3/0	1	3.0	400	500
	575		260	6	3/0 (3)	1	3.0	350	400
400	460	60	306	6	3/0	1	3.0	400	500
	575		260	6	3/0 (3)	1	3.0	350	400
420	460	60	306	6	3/0	1	3.0	400	500
	575		260	6	3/0 (3)	1	3.0	350	400
440	460	60	337	6	4/0	1	3.0	450	500
	575		285	6	3/0	1	3.0	350	450
450	460	60	337	6	4/0	1	3.0	450	500
	575		285	6	3/0	1	3.0	350	450
475	460	60	337	6	4/0	1	3.0	450	500
	575		285	6	3/0	1	3.0	350	450

**NOTES:**

1. Table based on 75°C field wire.
2. Complete notes are on page 30.
3. 3/0 wire is required for the disconnect switch option, 2/0 may be used for power block connection.

**Table 16, AGS230B–AGS 475B, Compressor and Condenser Fan Motor Amp Draw**

AGS UNIT SIZE	VOLTS	HZ	RATED LOAD AMPS			NO OF FAN MOTORS	FAN MOTORS FLA (EACH)	L R A FAN MOTORS (EACH)
			CIRCUIT #1	CIRCUIT #2	CIRCUIT #3			
230	460	60	195	195	-	12	3.0	20
	575		171	171	-		2.7	18
250	460	60	195	225	-	14	3.0	20
	575		171	190	-		2.7	18
270	460	60	225	225	-	16	3.0	20
	575		190	190	-		2.7	18
300	460	60	225	250	-	16	3.0	20
	575		190	210	-		2.7	18
320	460	60	250	250	-	16	3.0	20
	575		210	210	-		2.7	18
340	460	60	195	195	195	18	3.0	20
	575		171	171	171		2.7	18
370	460	60	195	195	225	20	3.0	20
	575		171	171	190		2.7	18
400	460	60	195	225	225	22	3.0	20
	575		171	190	190		2.7	18
420	460	60	225	225	225	24	3.0	20
	575		190	190	190		2.7	18
440	460	60	225	225	250	24	3.0	20
	575		190	190	210		2.7	18
450	460	60	225	250	250	24	3.0	20
	575		190	210	210		2.7	18
475	460	60	250	250	250	24	3.0	20
	575		210	210	210		2.7	18

**Table 17, AGS 230B – AGS 475B, Customer Wiring Information With Single-Point Power**

AGS UNIT SIZE	VOLTS	HZ	WIRING TO STANDARD UNIT POWER BLOCK		WIRING TO OPTIONAL NONFUSED DISCONNECT SWITCH IN UNIT	
			TERMINAL SIZE AMPS	CONNECTOR LUG RANGE PER PHASE (COPPER WIRE ONLY)	SIZE	CONNECTOR LUG RANGE PER PHASE (COPPER WIRE ONLY)
230	460	60	1000	#6-350	800	#6-350
	575		1000	#6-350	800	#6-350
250	460	60	1000	#6-350	800	#6-350
	575		1000	#6-350	800	#6-350
270	460	60	1000	#6-350	800	#6-350
	575		1000	#6-350	800	#6-350
300	460	60	1000	#6-350	800	#6-350
	575		1000	#6-350	800	#6-350
320	460	60	1000	#6-350	800	#6-350
	575		1000	#6-350	800	#6-350
340	460	60	1000	#6-350	1000	#6-350
	575		1000	#6-350	800	#6-350
370	460	60	1000	#6-350	1000	#6-350
	575		1000	#6-350	800	#6-350
400	460	60	1000	#6-350	1000	#6-350
	575		1000	#6-350	800	#6-350
420	460	60	1000	#6-350	1000	#6-350
	575		1000	#6-350	800	#6-350
440	460	60	1000	#6-350	1000	#6-350
	575		1000	#6-350	800	#6-350
450	460	60	1000	#6-350	1000	#6-350
	575		1000	#6-350	800	#6-350
475	460	60	1000	#6-350	1000	#6-350
	575		1000	#6-350	800	#6-350

1. Terminal size amps are the maximum amps that the power block is rated for.
2. Complete notes are on page 30.

**Table 18, AGS 230B–AGS 475B, Wiring Information with Multiple-Point**

AGS UNIT SIZE	VOLTS	HZ	WIRING TO UNIT POWER BLOCK					
			TERMINAL SIZE (AMPS)			CONNECTOR WIRE RANGE PER PHASE (COPPER WIRE ONLY)		
			CKT 1	CKT 2	CKT 3	CKT 1	CKT 2	CKT 3
230	460	60	400	400	--	#6-350	#6-350	--
	575							
250	460	60	400	400	--	#6-350	#6-350	--
	575							
270	460	60	400	400	--	#6-350	#6-350	--
	575							
300	460	60	400	400	--	#6-350	#6-350	--
	575							
320	460	60	400	400	--	#6-350	#6-350	--
	575							
340	460	60	400	400	400	#6-350	#6-350	#6-350
	575							
370	460	60	400	400	400	#6-350	#6-350	#6-350
	575							
400	460	60	400	400	400	#6-350	#6-350	#6-350
	575							
420	460	60	400	400	400	#6-350	#6-350	#6-350
	575							
440	460	60	400	400	400	#6-350	#6-350	#6-350
	575							
450	460	60	400	400	400	#6-350	#6-350	#6-350
	575							
475	460	60	400	400	400	#6-350	#6-350	#6-350
	575							

1. Terminal size amps are the maximum amps that the power block is rated for.
2. Complete notes are on page 30.

**Table 19, AGS 230B–AGS 475B, Wiring Information with Multiple-Point**

AGS UNIT SIZE	VOLTS	HZ	WIRING TO UNIT DISCONNECT SWITCH					
			TERMINAL SIZE (AMPS)			CONNECTOR WIRE RANGE PER PHASE (COPPER WIRE ONLY)		
			CKT 1	CKT 2	CKT 3	CKT 1	CKT 2	CKT 3
230	460	60	400	400	-	3/0 - 500	3/0 - 500	-
	575							
250	460	60	400	400	-	3/0 - 500	3/0 - 500	-
	575							
270	460	60	400	400	-	3/0 - 500	3/0 - 500	-
	575							
300	460	60	400	400	-	3/0 - 500	3/0 - 500	-
	575							
320	460	60	400	400	-	3/0 - 500	3/0 - 500	-
	575							
340	460	60	400	400	400	3/0 - 500	3/0 - 500	3/0 - 500
	575							
370	460	60	400	400	400	3/0 - 500	3/0 - 500	3/0 - 500
	575							
400	460	60	400	400	400	3/0 - 500	3/0 - 500	3/0 - 500
	575							
420	460	60	400	400	400	3/0 - 500	3/0 - 500	3/0 - 500
	575							
440	460	60	400	400	400	3/0 - 500	3/0 - 500	3/0 - 500
	575							
450	460	60	400	400	400	3/0 - 500	3/0 - 500	3/0 - 500
	575							
475	460	60	400	400	400	3/0 - 500	3/0 - 500	3/0 - 500
	575							

## Electrical Data Notes

1. Allowable voltage limits  
Unit nameplate 460V/60Hz/3Ph: 414V to 506V  
Unit nameplate 575V/60Hz/3Ph: 518V to 632V
2. Unit wire size ampacity (MCA) is equal to 125% of the largest compressor-motor RLA plus 100% of RLA of all other loads in the circuit.
3. Single point power supply requires a single disconnect to supply electrical power to the unit. This power must be fused.
4. All field wiring to unit power block or optional nonfused disconnect switch must be copper.
5. External disconnect switch(s) or HACR breakers must be field supplied.

---

**Note:** A non-fused disconnect switch in the cabinet is available as an option for single-point or multi-point power connections.

---

6. All wiring must installed as NEC Class 1 wiring system with conductor rated 600 volts and be done in accordance with applicable local and national codes.
7. Recommended time delay fuse size or HACR circuit breakers are equal to 150% of the largest compressor motor RLA plus 100% of remaining compressor RLAs and the sum of condenser fan FLAs.
8. Maximum time delay fuse size or HACR circuit breakers are equal to 225% of the largest compressor-motor RLA plus 100% of remaining compressor RLAs and the sum of condenser fan FLAs.
9. If the evaporator heater is to be powered during winter shutdown and it is desired to disconnect the main power to the unit, then the unit-mounted 3 kva control transformer can be unwired and a field 115-volt, 30 amp power source wired to terminals TB1-1 and TB1-2. The MicroTech II control must be powered in order for the heater to work.
10. If: 1) the evaporator heater is to be powered during winter shutdown and 2) it is desired to disconnect 400 volt power to the unit, then the unit-mounted 3 kva control transformer can be unwired and a field 110-volt power source wired to terminals TB1-1 and TB1-2. The MicroTech II control must be powered in order for the heater to work.
11. Ground lug is good for #6 to 250MCM wire.

## Optional Protocol Selectability Connection

Optional Protocol Selectability BAS interfaces. The locations and interconnection requirements for the various standard protocols are found in their respective installation manuals, obtainable from the local McQuay sales office and also shipped with each unit:

Modbus IM 743

LONWORKS IM735

BACnet IM736

## Power Limitations:

1. Voltage within  $\pm 10$  percent of nameplate rating.
2. Voltage unbalance not to exceed 2% with a resultant current unbalance of 6 to 10 times the voltage unbalance per NEMA MG-1, 1998 Standard.

# Field Wiring Diagram

**Figure 6, Typical Field Wiring Diagram, Circuit #1 Control Box**

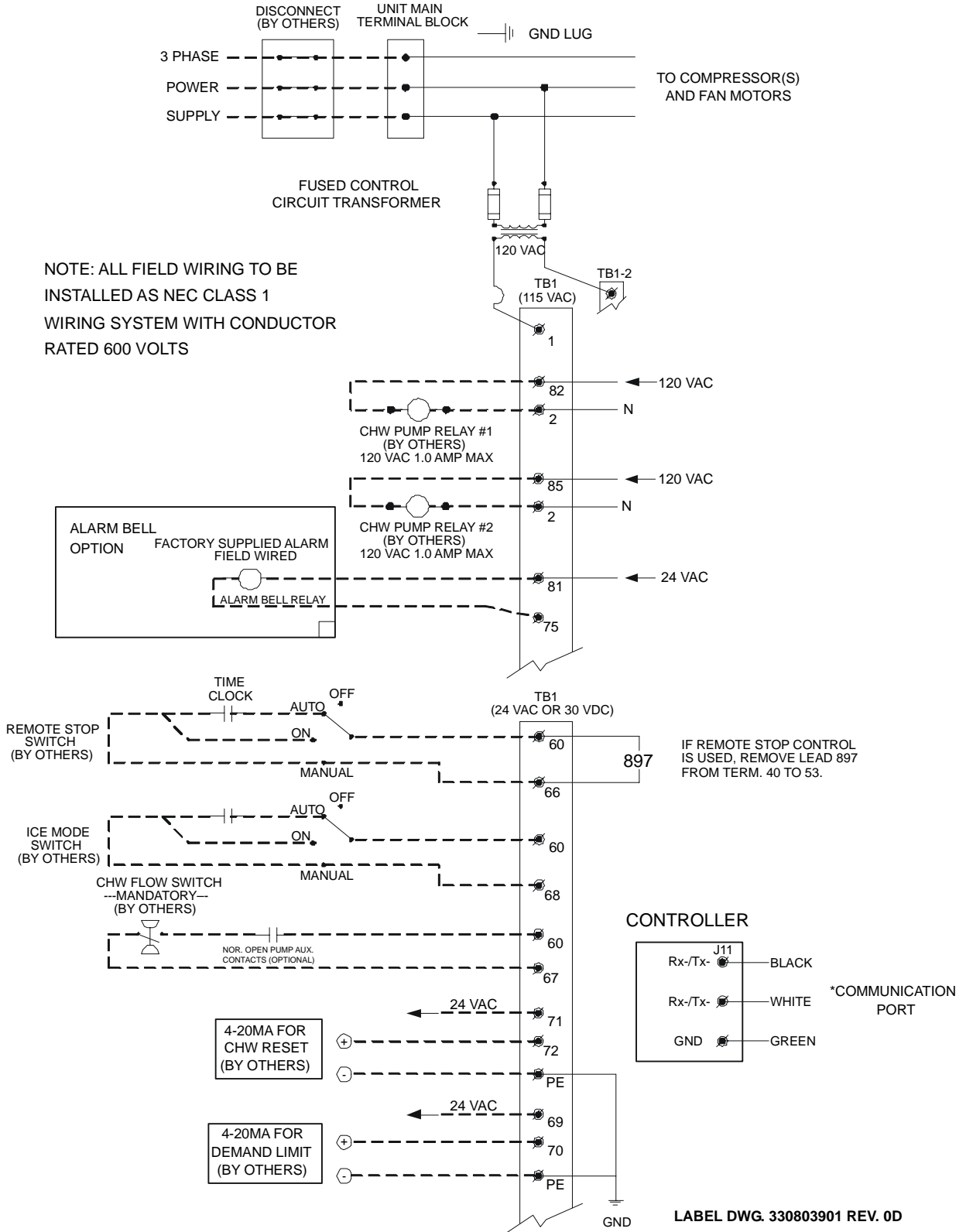



# Physical Data

**Table 20, Physical Data, AGS 230B – AGS 270B**

DATA	AGS MODEL NUMBER					
	230B		250B		270B	
	Ckt 1	Ckt 2	Ckt 1	Ckt 2	Ckt 1	Ckt 2
<b>BASIC DATA</b>						
Unit Cap. @ ARI Conditions, tons (kW)	220.5 (774)		243.9 (856)		267.5 (939)	
Unit Operating Charge lbs (kg)	298 (135)	298 (135)	298 (135)	321 (145)	321 (145)	321 (145)
Cabinet Dimensions L x W x H, in. (mm)	278 x 88 x 100 (7087 x 2235 x 2550)		317 x 88 x 100 (8052 x 2235 x 2550)		355 x 88 x 100 (9017 x 2235 x 2550)	
Unit Operating Weight (1), lbs. (kg)	16285 (7394)		17301 (7855)		18319 (8317)	
Unit Shipping Weight (1), lbs (kg)	15862 (7201)		16877 (7662)		17895 (8124)	
<b>COMPRESSORS, SCREW, SEMI-HERMETIC</b>						
Nominal Capacity, tons (kW)	100 (350)	100 (350)	100 (350)	125 (437)	125 (437)	125 (437)
<b>CONDENSERS, HIGH EFFICIENCY FIN AND TUBE TYPE WITH INTEGRAL SUBCOOLER</b>						
Coil Face Area, ft <sup>2</sup> . (m <sup>2</sup> )	159 (14.8)	159 (14.8)	159 (14.8)	213 (19.8)	213 (19.8)	213 (19.8)
Fins Per Inch x Rows Deep	16 x 3	16 x 3	16 x 3	16 x 3	16 x 3	16 x 3
<b>CONDENSER FANS, DIRECT DRIVE PROPELLER TYPE</b>						
No. of Fans -- Fan Dia., in. (mm)	12 – 30 (762)		14 – 30 (762)		16 – 30 (762)	
No. of Motors -- hp (kW)	12 – 2 (1.5)		14 – 2 (1.5)		16 – 2 (1.5)	
Fan & Motor RPM, 60Hz	1140		1140		1140	
60 Hz Fan Tip Speed, fpm	8954		8954		8954	
60 Hz Total Unit Airflow, cfm (l/s)	129,600		151,200		172,800	
<b>EVAPORATOR, FLOODED SHELL AND TUBE</b>						
Shell Dia.-Tube Length in.(mm) - in. (mm)	24 (610) – 96 (2438)		24 (610) – 96 (2438)		24 (610) – 96 (2438)	
Evaporator R-134a Charge lbs (kg)	182 (37)	182 (37)	182 (37)	182 (37)	182 (37)	182 (37)
Water Volume, gallons (liters)	48 (182)		48 (182)		48 (182)	
Max. Water Pressure, psi (kPa)	150 (1034)		150 (1034)		150 (1034)	
Max. Refrigerant Press., psi (kPa)	200 (1379)		200 (1379)		200 (1379)	

NOTE: 1. Add 158 lbs (72 kg) per fan for copper fin coils.

**Table 21, Physical Data, AGS 300B – AGS 320B**

DATA	AGS MODEL NUMBER			
	300B		320B	
	Ckt 1	Ckt 2	Ckt 1	Ckt 2
<b>BASIC DATA</b>				
Unit Cap. @ ARI, tons (kW)	283.1 (994)		300.9 (1056)	
Unit Operating Charge lbs (kg)	335 (152)	335 (152)	360 (163)	360 (163)
Cabinet Dimensions L x W x H, in. (mm)	355 x 88 x 100 (9017 x 2235 x 2550)		355 x 88 x 100 (9017 x 2235 x 2550)	
Unit Operating Weight (1), lbs. (kg)	18447 (8375)		18787 (8266)	
Unit Shipping Weight(1), lbs (kg)	17995 (8170)		18272 (8295)	
<b>COMPRESSORS, SCREW, SEMI-HERMETIC</b>				
Nominal Capacity, tons (kW)	125 (437)	150 (525)	150 (525)	150 (525)
<b>CONDENSERS, HIGH EFFICIENCY FIN AND TUBE TYPE WITH INTEGRAL SUBCOOLER</b>				
Coil Face Area, ft <sup>2</sup> . (m <sup>2</sup> )	213 (19.8)	213 (19.8)	213 (19.8)	213 (19.8)
Fins Per Inch x Rows Deep	16 x 3	16 x 3	16 x 3	16 x 3
<b>CONDENSER FANS, DIRECT DRIVE PROPELLER TYPE</b>				
No. of Fans -- Fan Dia., in. (mm)	16 – 30 (762)		16 – 30 (762)	
No. of Motors -- hp (kW)	16 – 2 (1.5)		16 – 2 (1.5)	
Fan & Motor RPM, 60Hz	1140		1140	
60 Hz Fan Tip Speed, fpm	8954		8954	
60 Hz Total Unit Airflow, cfm (l/s)	172,800		172,800	
<b>EVAPORATOR, FLOODED SHELL AND TUBE</b>				
Shell Dia.-Tube Length in.(mm) - in. (mm)	24 (610) – 96 (2438)		26 (660) – 96 (2438)	
Evaporator R-134a Charge lbs (kg)	196 (89)	196 (89)	221 (100)	221 (100)
Water Volume, gallons (liters)	51 (195)		59 (221)	
Max. Water Pressure, psi (kPa)	150 (1034)		150 (1034)	
Max. Refrigerant Press., psi (kPa)	200 (1379)		200 (1379)	

NOTE: 1. Add 158 lbs (72 kg) per fan for copper fin coils.

**Table 22, Physical Data, AGS 340B – AGS 400B**

DATA	AGS MODEL NUMBER								
	340B			370B			400B		
	Ckt. 1	Ckt. 2	Ckt. 3	Ckt. 1	Ckt. 2	Ckt. 3	Ckt. 1	Ckt. 2	Ckt. 3
<b>BASIC DATA</b>									
Unit Cap. @ ARI, tons (kW)	334.1 (1173)			360.0 (1264)			384.3 (1349)		
Unit Operating Charge, lbs (kg)	285 (129)	285 (129)	285 (129)	312 (141)	312 (141)	312 (141)	312 (141)	335 (152)	335 (152)
Cabinet Dim., L x W x H, in. (mm)	434 x 88 x 100 (11024 x 2235 x 2550)			472 x 88 x 100 (11989 x 2235 x 2550)			510 x 88 x 100 (12954 x 2235 x 2550)		
Operating Weight(1), lbs. (kg)	23507 (10672)			25645 (11643)			26667 (11734)		
Shipping Weight(1), lbs (kg)	22958 (10101)			25034 (11015)			26056 (11829)		
<b>COMPRESSORS, SCREW, SEMI-HERMETIC</b>									
Nominal Capacity, tons (kW)	100 (350)	100 (350)	100 (350)	100 (350)	100 (350)	125 (437)	100 (350)	125 (437)	125 (437)
<b>CONDENSERS, HIGH EFFICIENCY FIN AND TUBE TYPE WITH INTEGRAL SUBCOOLER</b>									
Coil Face Area, ft <sup>2</sup> . (m <sup>2</sup> )	159 (14.8)	159 (14.8)	159 (14.8)	159 (14.8)	159 (14.8)	213 (19.9)	159 (14.8)	213 (19.9)	213 (19.9)
Fins Per Inch x Rows Deep	16 x 3	16 x 3	16 x 3	16 x 3	16 x 3	16 x 3	16 x 3	16 x 3	16 x 3
<b>CONDENSER FANS, DIRECT DRIVE PROPELLER TYPE</b>									
No. of Fans - Fan Dia., in. (mm)	18 – 30 (762)			20 – 30 (762)			22 – 30 (732)		
No. of Motors -- hp (kW)	18 – 2 (1.5)			20 – 2 (1.5)			22 – 2 (1.5)		
Fan & Motor RPM, 60Hz	1140			1140			1140		
60 Hz Fan Tip Speed, fpm	8954			8954			8954		
60 Hz Total Unit Airflow, cfm (l/s)	194,400			216,000			237,600		
<b>EVAPORATOR, FLOODED SHELL AND TUBE</b>									
Shell Dia., Tube Length in.(mm)	26 (660) – 108 (2743)			30 (762) – 108 (2743)			30 (762) – 108 (2743)		
Evaporator R-134a Charge lbs (kg)	164 (74)	164 (74)	164 (74)	191 (86)	191 (86)	191 (86)	191 (86)	191 (86)	191 (86)
Water Volume, gallons (liters)	63 (237)			70 (263)			70 (263)		
Max. Water Pressure, psi (kPa)	150 (1034)			150 (1034)			150 (1034)		
Max. Refrigerant Press., psi (kPa)	200 (1379)			200 (1379)			200 (1379)		

NOTE: 1. Add 158 lbs (72 kg) per fan for copper fin coils.

**Table 23, Physical Data, AGS 420B – AGS 440B**

DATA	AGS MODEL NUMBER					
	420B			440B		
	Ckt. 1	Ckt. 2	Ckt. 3	Ckt. 1	Ckt. 2	Ckt. 3
<b>BASIC DATA</b>						
Unit Cap. @ ARI, tons (kW)	408.8 (1435)			427.1 (1499)		
Unit Operating Charge, lbs (kg)	335 (152)	335 (152)	335 (152)	358 (162)	358 (162)	358 (162)
Cabinet Dim., L x W x H, in. (mm)	548 x 88 x 100 (13919 x 2235 x 2550)			548 x 88 x 100 (13919 x 2235 x 2550)		
Unit Operating Weight, lbs. (kg)	27684 (12568)			28042 (12731)		
Unit Shipping Weight, lbs (kg)	27072 (12291)			27345 (12415)		
<b>COMPRESSORS, SCREW, SEMI-HERMETIC</b>						
Nominal Capacity, tons (kW)	125 (437)	125 (437)	125 (437)	125 (437)	125 (437)	150 (525)
<b>CONDENSERS, HIGH EFFICIENCY FIN AND TUBE TYPE WITH INTEGRAL SUBCOOLER</b>						
Coil Face Area, ft <sup>2</sup> . (m <sup>2</sup> )	213 (19.9)	213 (19.9)	213 (19.9)	213 (19.9)	213 (19.9)	213 (19.9)
Fins Per Inch x Rows Deep	16 x 3	16 x 3	16 x 3	16 x 3	16 x 3	16 x 3
<b>CONDENSER FANS, DIRECT DRIVE PROPELLER TYPE</b>						
No. of Fans -- Fan Dia., in. (mm)	24 – 30 (762)			24 – 30 (762)		
No. of Motors -- hp (kW)	24 – 2 (1.5)			24 – 2 (1.5)		
Fan & Motor RPM, 60Hz	1140			1140		
60 Hz Fan Tip Speed, fpm	8954			8954		
60 Hz Total Unit Airflow, cfm (l/s)	259,200			259,200		
<b>EVAPORATOR, FLOODED SHELL AND TUBE</b>						
Shell Dia. -- Tube Length in.(mm) - in. (mm)	30 (762) – 108 (2743)			30 (762) – 108 (2743)		
Evaporator R-134a Charge lbs (kg)	191 (86)	191 (86)	191 (86)	214 (97)	214 (97)	214 (97)
Water Volume, gallons (liters)	70 (263)			79 (300)		
Max. Water Pressure, psi (kPa)	150 (1034)			150 (1034)		
Max. Refrigerant Press., psi (kPa)	200 (1379)			200 (1379)		

NOTE: 1. Add 158 lbs (72 kg) per fan for copper fin coils.

**Table 24, Physical Data, AGS 450B – AGS 475B**

DATA	AGS MODEL NUMBER					
	450B			475B		
	Ckt. 1	Ckt. 2	Ckt. 3	Ckt. 1	Ckt. 2	Ckt. 3
<b>BASIC DATA</b>						
Unit Cap. @ ARI, tons (kW)	440.5 (1546)			453.9 (1593)		
Unit Operating Charge, lbs (kg)	358 (162)	358 (162)	358 (162)	358 (162)	358 (162)	358 (162)
Cabinet Dim., L x W x H, in. (mm)	548 x 88 x 100 (13919 x 2235 x 2550)			548 x 88 x 100 (13919 x 2235 x 2550)		
Operating Weight (1), lbs. (kg)	28042 (12731)			28042 (12731)		
Shipping Weight(1), lbs (kg)	27345 (12415)			27345 (12415)		
<b>COMPRESSORS, SCREW, SEMI-HERMETIC</b>						
Nominal Capacity, tons (kW)	125 (437)	150 (525)	150 (525)	150 (525)	150 (525)	150 (525)
<b>CONDENSERS, HIGH EFFICIENCY FIN AND TUBE TYPE WITH INTEGRAL SUBCOOLER</b>						
Coil Face Area, ft <sup>2</sup> . (m <sup>2</sup> )	213 (19.9)	213 (19.9)	213 (19.9)	213 (19.9)	213 (19.9)	213 (19.9)
Fins Per Inch x Rows Deep	16 x 3	16 x 3	16 x 3	16 x 3	16 x 3	16 x 3
<b>CONDENSER FANS, DIRECT DRIVE PROPELLER TYPE</b>						
No. of Fans -- Fan Dia., in. (mm)	24 – 30 (762)			24 – 30 (762)		
No. of Motors -- hp (kW)	24 – 2 (1.5)			24 – 2 (1.5)		
Fan & Motor RPM, 60Hz	1140			1140		
60 Hz Fan Tip Speed, fpm	8954			8954		
60 Hz Total Unit Airflow, cfm (l/s)	259,200			259,200		
<b>EVAPORATOR, FLOODED SHELL AND TUBE</b>						
Shell Dia. -- Tube Length in.(mm) - in. (mm)	30 (762) – 108 (2743)			30 (762) – 108 (2743)		
Evaporator R-134a Charge lbs (kg)	214 (97)	214 (97)	214 (97)	214 (97)	214 (97)	214 (97)
Water Volume, gallons (liters)	79 (300)			79 (300)		
Max. Water Pressure, psi (kPa)	150 (1034)			150 (1034)		
Max. Refrigerant Press. psi (kPa)	200 (1379)			200 (1379)		

**NOTE:** 1. Add 158 lbs (72 kg) per fan for copper fin coils.

# Dimensions, AGS

**Figure 7, Dimensions, AGS 230B – AGS 320B**

**Note:** See page 37 for lifting locations, mounting locations, weights and mounting loads.

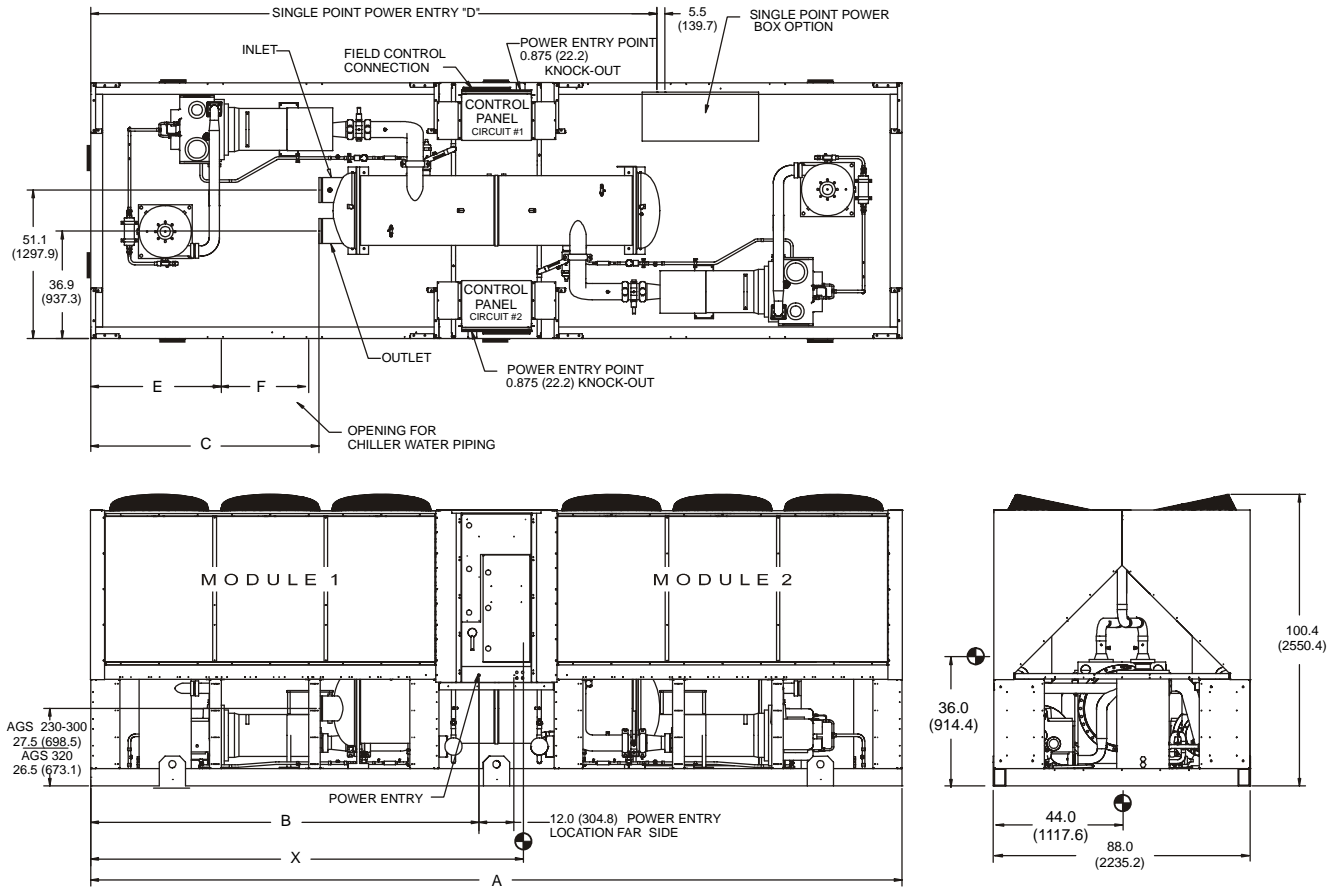

DWG. 330556901-R3

**NOTES:**

1. Chilled water piping must enter and exit the unit platform in the opening between the base rail and the bottom of the condenser coil as shown in the plan view above.
2. Victaulic connections are standard. Flanged connection available as an option. Mating flange is field-supplied.

AGS Unit Size	Dimensions inches (mm)				Water Piping inches (mm)		Connection Sizes inches (mm)	Center of Gravity in. (mm) X	Fan Modules		
	A	B	C	D	E	F			No. of Fans	1	2
AGS 230	278.8 (7081.5)	133.4 (3388.4)	78.4 (1991.4)	192.6 (4892.0)	44.8 (1137.4)	30.0 (762.8)	8 (203.2)	139 (3531)	12 Fan	6	6
AGS 250	316.9 (8049.3)	133.4 (3388.4)	78.4 (1991.4)	192.6 (4892.6)	44.8 (1137.4)	30.0 (762.8)	8 (203.2)	146 (3708)	14 Fan	6	8
AGS 270-320	355.2 (9022.1)	171.6 (4358.6)	116.6 (2961.6)	230.8 (5862.3)	80.9 (2054.8)	31.4 (797.6)	8 (203.2)	177 (4496)	16 Fan	8	8

**Figure 8, Dimensions, AGS 340B–475B**

**Note:** See page 38 for lifting locations, mounting locations, weights and mounting loads.

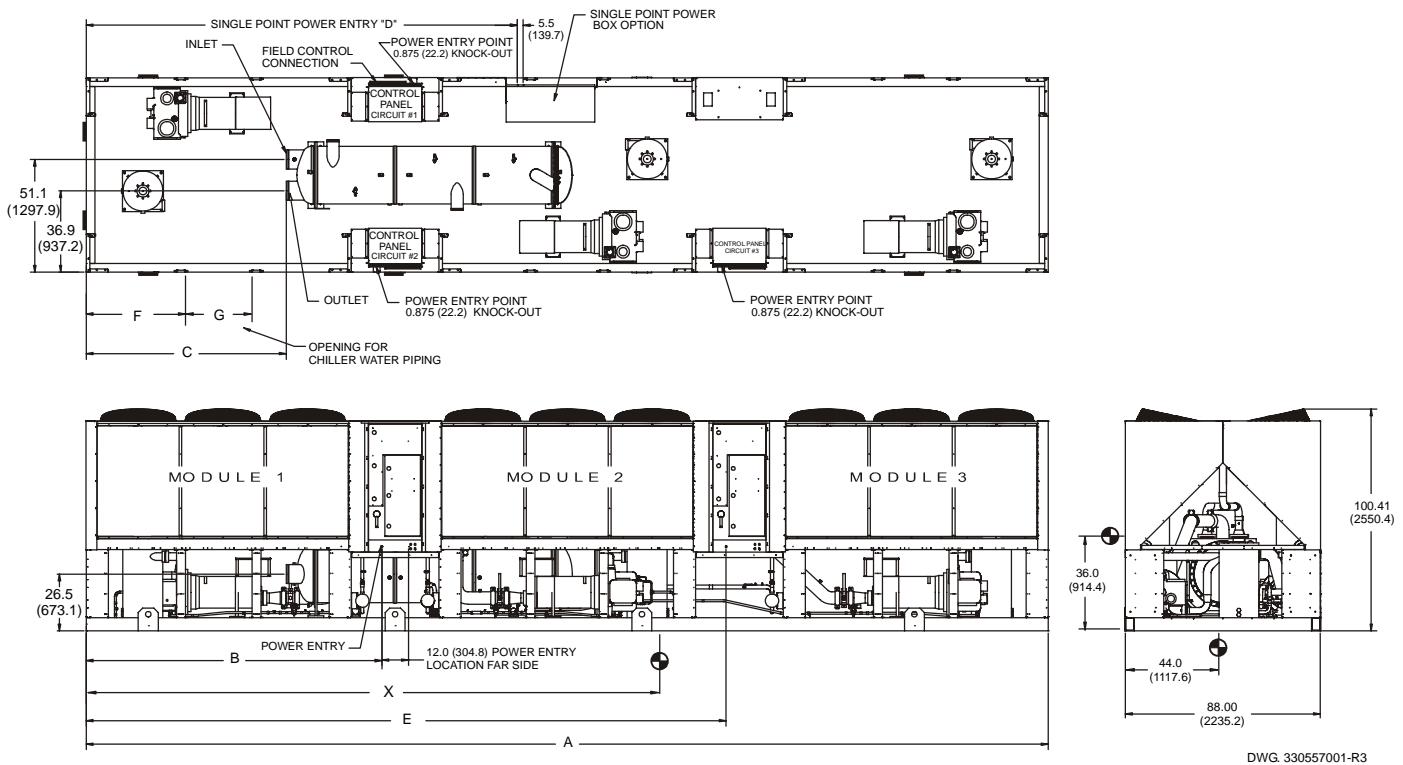

**NOTES:**

1. Chilled water piping must enter and exit the unit platform in the opening between the base rail and the bottom of the condenser coil as shown in the plan view above.
2. Victaulic connections are standard. Flanged connection available as an option. Mating flange is field-supplied.

AGS Unit Size	Dimensions Inches (mm)					Water Piping inches (mm)		Connection Sizes inches (mm)	Center of Gravity in. (mm)	Fan Modules			
	A	B	C	D	E	F	G			No. of Fans	1	2	3
	X												
340	434.2 (11027.9)	133.4 (3388.0)	90.3 (2292.4)	192.6 (4892.0)	288.8 (7335.5)	44.7 (1137.4)	30.0 (762.8)	8 (203.2)	210 (5334)	18	6	6	6
370	472.4 (11998.2)	133.4 (3388.1)	90.3 (2292.4)	192.6 (4892.0)	288.8 (7335.5)	44.7 (1137.4)	30.0 (762.8)	10 (254.0)	215 (5461)	20	6	6	8
400	510.6 (12968.5)	133.4 (3388.1)	87.3 (2140.0)	192.6 (4892.0)	327.0 (8305.8)	44.7 (1137.4)	30.0 (762.8)	10 (254.0)	228 (5791)	22	6	8	8
420-475	548.8 (13939.0)	171.6 (4358.4)	125.5 (3186.4)	230.8 (5862.3)	365.2 (9276.1)	80.9 (2054.8)	31.4 (797.6)	10 (254.0)	260 (6604)	24	8	8	8

**Figure 9, AGS 230B – AGS 250B Lifting and Mounting Locations**

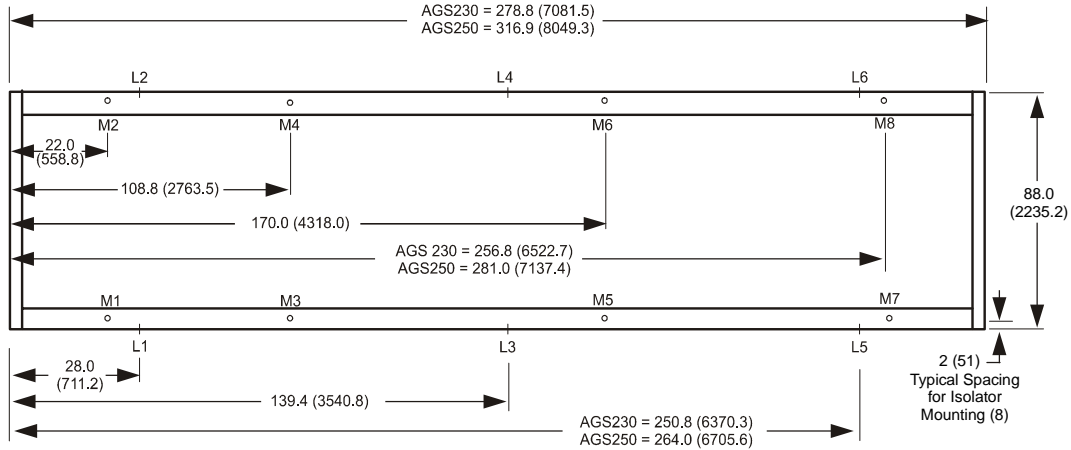

**Figure 10, AGS 270B - AGS 320B Lifting and Mounting Locations**

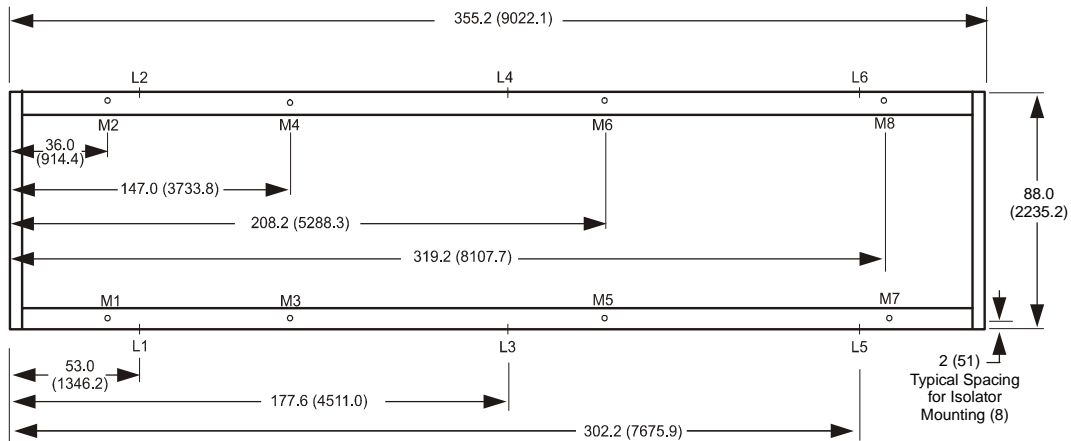

**Table 25, AGS 230B - AGS 320B Lifting and Mounting Weights (Aluminum Fin)**

AGS Model		Lifting Weight for Each Point lb (kg)						Mounting Loads for Each Point lb. (kg)							
		L1	L2	L3	L4	L5	L6	M1	M2	M3	M4	M5	M6	M7	M8
230B	Lbs.	2183	3043	2563	2563	3043	2183	1683	2325	1681	2322	2322	1681	2325	1683
	(kg)	991	1382	1164	1164	1382	991	764	1055	763	1054	1054	763	1055	764
250B	Lbs.	2183	3043	2700	2704	3374	2509	1683	2325	1681	2322	2693	2018	2421	1814
	(kg)	991	1382	1226	1228	1532	1139	764	1055	763	1054	1223	916	1099	824
270B	Lbs.	2509	3374	2841	2841	3374	2509	1814	2421	2018	2693	2693	2018	2421	1814
	(kg)	1139	1532	1290	1290	1532	1139	824	1099	916	1223	1223	916	1099	824
300B	Lbs.	2520	3383	2871	2871	3383	2520	1821	2425	2043	2721	2721	2043	2425	1821
	(kg)	1144	1536	1304	1304	1536	1144	827	1101	928	1235	1235	928	1101	827
320B	Lbs.	2550	3407	2956	2956	3407	2550	1838	2435	2111	2797	2797	2111	2435	1838
	(kg)	1158	1547	1342	1342	1547	1158	834	1106	958	1270	1270	958	1106	834

**NOTES:**

1. Lifting tabs with 2½ in. (63.5 mm) holes at location "L" on side of base rail.
2. 1 in. (25.4 mm) mounting holes at location "M" on bottom of base rails.

**Table 26, AGS 230B - AGS 320B Lifting and Mounting Weights (Copper Fin)**

AGS Model		Lifting Weight for Each Point lb (kg)						Mounting Loads for Each Point lb. (kg)							
		L1	L2	L3	L4	L5	L6	M1	M2	M3	M4	M5	M6	M7	M8
230B	Lbs.	2499	3359	2879	2879	3359	2499	1920	2562	1918	2559	2559	1918	2562	1920
	(kg)	1135	1525	1307	1307	1525	1135	872	1163	871	1162	1162	871	1163	872
250B	Lbs.	2552	3412	3069	3073	3743	2878	1960	2602	1958	2599	2970	2295	2698	2091
	(kg)	1158	1549	1393	1395	1699	1306	890	1181	889	1180	1348	1042	1225	949
270B	Lbs.	2930	3795	3262	3262	3795	2930	2130	2737	2334	3009	3009	2334	2737	2130
	(kg)	1330	1723	1481	1481	1723	1330	967	1243	1060	1366	1366	1060	1243	967
300B	Lbs.	2941	3804	3292	3292	3804	2941	2137	2741	2359	3037	3037	2359	2741	2137
	(kg)	1335	1727	1495	1495	1727	1335	970	1244	1071	1379	1379	1071	1244	970
320B	Lbs.	2971	3828	3377	3377	3828	2971	2154	2751	2427	3113	3113	2427	2751	2154
	(kg)	1349	1738	1533	1533	1738	1349	978	1249	1102	1413	1413	1102	1249	978

**NOTES:**

1. Lifting tabs with 2½ in. (63.5 mm) holes at location "L" on side of base rail.
2. 1 in. (25.4 mm) mounting holes at location "M" on bottom of base rails.

**Figure 11, AGS 340B – AGS 400B Lifting and Mounting Locations**

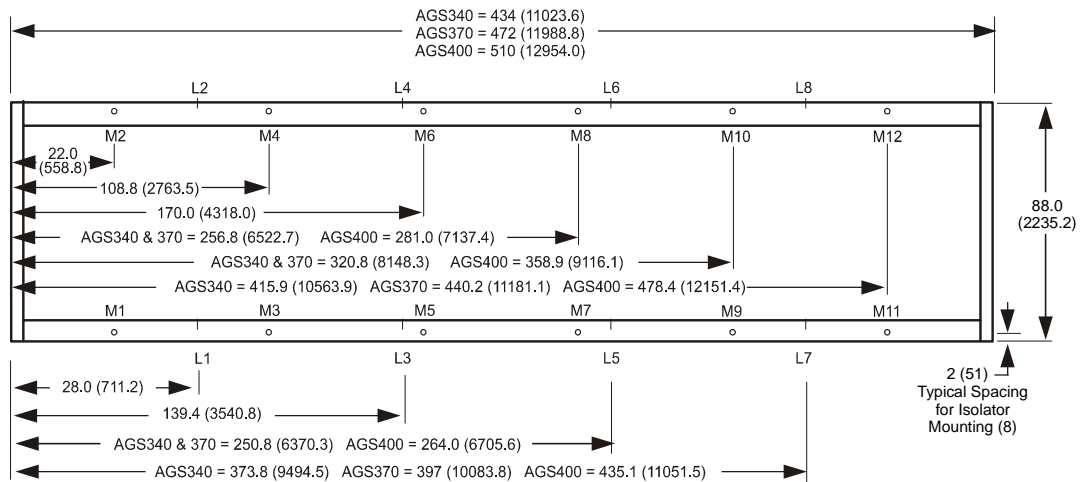

**Figure 12, AGS 420B - AGS 475B Lifting and Mounting Locations**

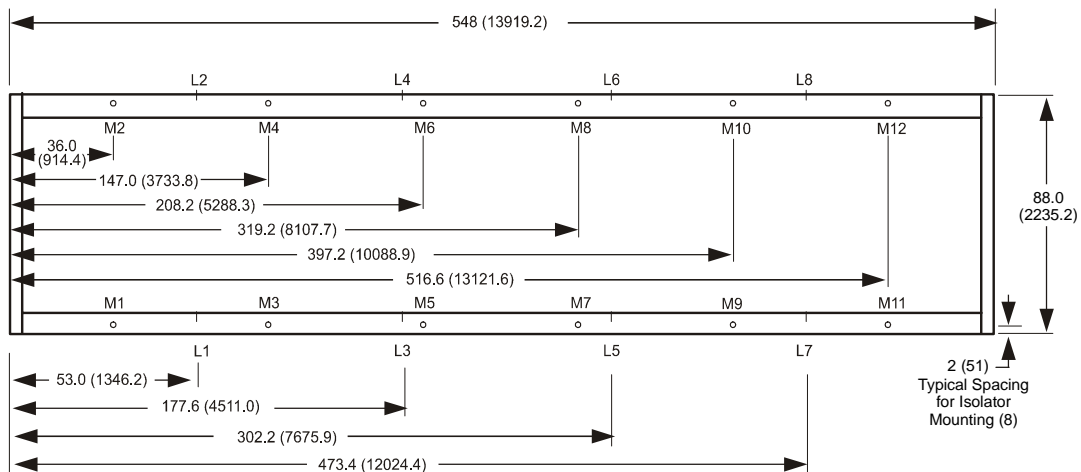

**Table 27, AGS 340B - AGS 475B Lifting Weights (Aluminum Fin)**

AGS Model		Lifting Weight for Each Point lb. (kg)							
		L1	L2	L3	L4	L5	L6	L7	L8
340B	lbs	2312	3173	2681	2681	3352	2473	3192	2880
	(kg)	1050	1441	1217	1217	1522	1123	1449	1307
370B	lbs	2449	3296	2951	2951	3617	2742	3519	3216
	(kg)	1112	1496	1340	1340	1642	1245	1597	1460
400B	lbs	2449	3296	3119	3117	3917	3044	3519	3216
	(kg)	1112	1496	1416	1415	1778	1382	1597	1460
420B	lbs	2751	3596	3285	3285	3917	3044	3519	3216
	(kg)	1249	1633	1491	1491	1778	1382	1597	1460
440B	lbs	2783	3624	3361	3361	3945	3076	3519	3216
	(kg)	1263	1645	1526	1526	1791	1396	1597	1460
450B	lbs	2783	3624	3361	3361	3945	3076	3519	3216
	(kg)	1263	1645	1526	1526	1791	1396	1597	1460
475B	lbs	2783	3624	3361	3361	3945	3076	3519	3216
	(kg)	1263	1645	1526	1526	1791	1396	1597	1460

**Table 28, AGS 340B - AGS 475B Lifting Weights (Copper Fin)**

AGS Model		Lifting Weight for Each Point lb. (kg)							
		L1	L2	L3	L4	L5	L6	L7	L8
340B	lbs	2668	3529	3037	3037	3708	2829	3548	3236
	(kg)	1211	1602	1379	1379	1683	1284	1611	1469
370B	lbs	2844	3691	3346	3346	4012	3137	3914	3611
	(kg)	1291	1676	1519	1519	1821	1424	1777	1639
400B	lbs	2884	3731	3554	3552	4352	3479	3954	3651
	(kg)	1309	1694	1613	1612	1976	1579	1795	1657
420B	lbs	3225	4070	3759	3759	4391	3518	3993	3690
	(kg)	1464	1848	1707	1707	1994	1597	1813	1675
440B	lbs	3257	4098	3835	3835	4419	3550	3993	3690
	(kg)	1479	1860	1741	1741	2006	1612	1813	1675
450B	lbs	3257	4098	3835	3835	4419	3550	3993	3690
	(kg)	1479	1860	1741	1741	2006	1612	1813	1675
475B	lbs	3257	4098	3835	3835	4419	3550	3993	3690
	(kg)	1479	1860	1741	1741	2006	1612	1813	1675

**Table 29, AGS 340B - AGS 475B Mounting Weights (Aluminum Fin)**

AGS Model		Mounting Loads for Each Point lb. (kg)											
		M1	M2	M3	M4	M5	M6	M7	M8	M9	M10	M11	M12
340B	lbs	1798	2442	1787	2426	2426	1787	2442	1798	1726	1557	1645	1484
	kg	816	1109	811	1101	1101	811	1109	816	784	707	747	674
370B	lbs	1885	2511	1981	2638	2638	1981	2511	1885	1973	1803	1867	1706
	kg	856	1140	899	1198	1198	899	1140	856	896	819	847	775
400B	lbs	1885	2511	1981	2638	3055	2357	2562	1977	1973	1803	1867	1706
	kg	856	1140	899	1198	1387	1070	1163	897	896	819	847	775
420B	lbs	1977	2562	2357	3055	3055	2357	2562	1977	1973	1803	1867	1706
	kg	897	1163	1070	1387	1387	1070	1163	897	896	819	847	775
440B	lbs	1999	2579	2425	3128	3128	2425	2579	1999	1973	1803	1867	1706
	kg	908	1171	1101	1420	1420	1101	1171	908	896	819	847	775
450B	lbs	1999	2579	2425	3128	3128	2425	2579	1999	1973	1803	1867	1706
	kg	908	1171	1101	1420	1420	1101	1171	908	896	819	847	775
475B	lbs	1999	2579	2425	3128	3128	2425	2579	1999	1973	1803	1867	1706
	kg	908	1171	1101	1420	1420	1101	1171	908	896	819	847	775



**Table 30, AGS 340B - AGS 475B Mounting Weights (Copper Fin)**

AGS Model		Mounting Loads for Each Point lb. (kg)											
		M1	M2	M3	M4	M5	M6	M7	M8	M9	M10	M11	M12
340B	lbs	2035	2679	2024	2663	2663	2024	2679	2035	1963	1794	1882	1721
	kg	924	1216	919	1209	1209	919	1216	924	891	814	854	781
370B	lbs	2148	2774	2244	2901	2901	2244	2774	2148	2236	2066	2130	1969
	kg	975	1260	1019	1317	1317	1019	1260	975	1015	938	967	894
400B	lbs	2175	2801	2271	2928	3345	2647	2852	2267	2263	2093	2157	1996
	kg	987	1272	1031	1329	1518	1202	1295	1029	1027	950	979	906
420B	lbs	2293	2878	2673	3371	3371	2673	2878	2293	2289	2119	2183	2022
	kg	1041	1307	1214	1530	1530	1214	1307	1041	1039	962	991	918
440B	lbs	2315	2895	2741	3444	3444	2741	2895	2315	2289	2119	2183	2022
	kg	1051	1314	1244	1564	1564	1244	1314	1051	1039	962	991	918
450B	lbs	2315	2895	2741	3444	3444	2741	2895	2315	2289	2119	2183	2022
	kg	1051	1314	1244	1564	1564	1244	1314	1051	1039	962	991	918
475B	lbs	2315	2895	2741	3444	3444	2741	2895	2315	2289	2119	2183	2022
	kg	1051	1314	1244	1564	1564	1244	1314	1051	1039	962	991	918

## Installation and Application

### Rigging

Care must be taken to avoid dropping the unit during unloading or moving as this can result in serious property damage and personal injury. Do not push or pull the unit. Do not lift the unit with a fork lift truck. To lift the unit, three (or four depending on unit size) 2 1/2 inch (65 mm) diameter lifting holes are provided on each side in the base of the unit. All lifting holes must be used when lifting the unit. Lengthwise and crosswise spreader bars must be used between rigging lines to prevent damage to the condenser coils or unit cabinet and to keep the lines coming up from the rigging holes to the spreaders vertical.



### WARNING

**Improper lifting or moving unit can result in property damage, severe personal injury or death. Carefully follow rigging and moving instructions located in the unit installation manual.**

### Unit Placement

For roof mounted applications, the unit must be installed on a steel channel or I-beam frame to support the unit above the roof. For ground level applications, the unit must be installed on a substantial base that will not settle. McQuay recommends a one piece concrete slab with footings extended below the frost line, and the installation engineer should determine its necessity. The foundation must be level within 1/2 inch (13mm) over its length and width and strong enough to support the unit's operating weight as listed in the Physical Data tables.

On ground level applications fin protection against vandalism is recommended, either by the optional factory installed lower guards or a field installed screen fence. Note that the fence must allow free flow of air to the condenser coil for proper unit operation. Wire mesh coil guards are standard.

## Operating Limits:

Maximum standby ambient temperature, 130°F (55°C)

Maximum operating ambient temperature, 115°F (46°C) or 125°F (52°C) with optional high ambient package

Minimum operating ambient temperature (standard), 35°F (2°C)

Minimum operating ambient temperature (optional low-ambient control), 0°F (-18°C)

Leaving chilled water temperature, 40°F to 50°F (4.4°C to 10°C)

Leaving chilled fluid temperature (with anti-freeze), 20°F to 50°F (7°C to 10°C)

Operating Delta-T range, 6 to 16 degrees F (3.3 to 8.8 degrees C)

Maximum operating inlet fluid temperature, 66°F (19°C)

Maximum startup inlet fluid temperature, 90°F (32°C)

Maximum non-operating inlet fluid temperature, 100°F (38°C)

---

**NOTE:** Contact the local McQuay sales office for operation outside of these limits.

---

## Ice Mode

No special options are required for ice mode operation. The standard controller software will require “ice” setpoint changes and a digital signal into the controller is required to change to the ice mode and back to standard cooling. See Figure 6 for connection location. The unit will operate at full load until the shutoff temperature is reached. Optional double evaporator insulation is recommended.

## Clearances

Air-cooled units require free air flow to and from the condenser coils. Installed units per the listed installation clearances. There must be **no obstructions** above the fan discharge that can cause air recirculation. Air restriction and recirculation can cause high pressure trips and will reduce capacity, efficiency, and compressor life. Do not install ductwork on condenser fans. Structures, other equipment, fencing, plants, and trees must be considered for air flow interference. Ventilators and any sources of contaminated or heated discharges gases and air will affect system performance. Pit type installation must meet McQuay’s requirements.

The power wiring connection is made at the lower left front of each control panel (optional single-point connection is to a separate box located on the unit base). Do not block access to the filter-driers mounted on the base under the control panel.

## Service Access

Compressors, filter-driers, and manual liquid line shutoff valves are accessible on each side of the unit adjacent to the control box. The evaporator heater is controlled by the MicroTech controller sensing the water temperature inside the evaporator.

Each compressor (two or three depending on unit size) has its own duplex control panel located on the sides of the chiller. The outer control box contains the compressor microprocessor. The box for circuit #1 also contains the unit microprocessor controller. The solid state starter, fan control and other power equipment are in the inner panel.

The side clearance required for air flow provides sufficient service clearance.

On all AGS units the condenser fans and motors can be removed from the top of the unit. The complete fan/motor assembly can be removed for service.

Do not block access to the sides or ends of the unit with piping or conduit. These areas must be open for service access. Do not block any access to the control panels with a field-mounted disconnect switches. In particular, be sure that the power conduit to each panel does not interfere with access to the filter-driers located on the unit base under the panels.

**Figure 13, Clearance Requirements, AGS 230B – 475B**

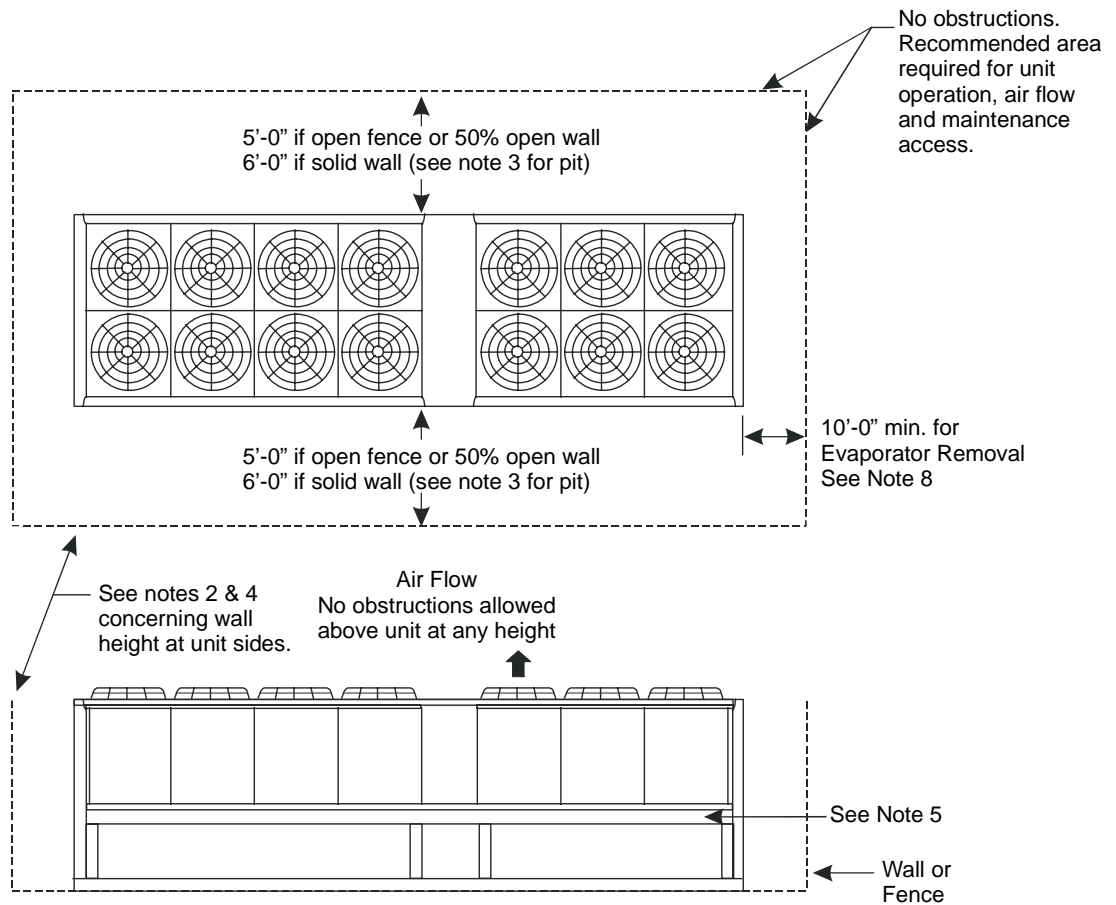

**Notes:**

1. Minimum side clearance between two units is 12 feet (3.7 meters).
2. Unit must not be installed in a pit or enclosure that is deeper or taller than the height of the unit unless extra clearance is provided per note 4.
3. Minimum clearance on each side is 8 feet (2.4 meters) when installed in a pit no deeper than the unit height.
4. Minimum side clearance to a side wall or building taller than the unit height is 6 feet (1.8 meters) provided no solid wall above 6 feet (1.8 meters) is closer than 12 feet (3.7 meters) to the opposite side of the unit.
5. Do not mount electrical conduits where they can block service access to compressor controls, refrigerant filter-driers or valves.
6. There must be no obstruction of the fan discharge.
7. Field installed switches must not interfere with service access or air flow.
8. The 10-ft. clearance required for removal of the evaporator is on the end that the evaporator connections face. See dimension drawings for detail.

# Restricted Air Flow

## General

The clearances required for design operation of AGS air-cooled condensers are described in the previous section. Occasionally, these clearances cannot be maintained due to site restrictions such as units being too close together or a fence or wall restricting airflow, or both.

Fortunately the McQuay AGS chillers have several features that can mitigate the penalties attributable to restricted airflow.

- The condenser section is “W” shaped, as shown below. This allows inlet air for these coils to come in from both sides and the bottom. All the coils in one “W” section serve one compressor. Every compressor always has its own independent refrigerant circuit.
- The MicroTech II control is proactive in response to “off-design conditions”. In the case of single or compounded influences restricting airflow to the unit, the microprocessor will act to keep the compressor(s) running (at reduced capacity) rather than allowing a shut-off on high discharge pressure.

**Figure 14, Coil and Fan Arrangement**

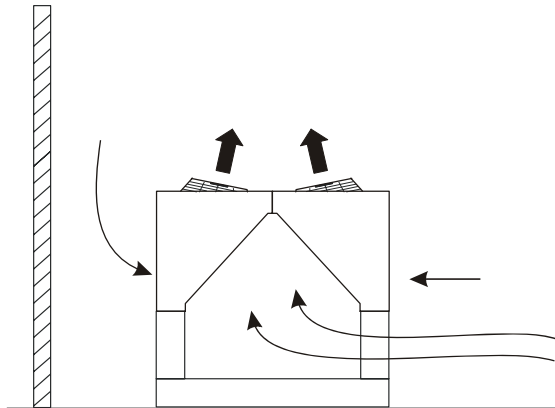

The following sections discuss the most common situations of condenser air restriction and give capacity and power adjustment factors for each. Note that in unusually severe conditions, the MicroTech II controller would adjust the unit operation to remain online until a less severe condition is reached.

### Case 1, Building or Wall on One Side of One Unit

The existence of a screening wall or the wall of a building in close proximity to an air-cooled chiller is common in both rooftop and ground level applications. Hot air recirculation on the coils adjoining the wall will increase compressor discharge pressure, decreasing capacity and increasing power consumption.

When close to a wall, it is desirable to place chillers on the North or East side of them. It is also desirable to have prevailing winds blowing parallel to the unit's long axis. The worst case is to have wind blowing hot discharge air into the wall.

**Figure 15, Unit Adjacent to Wall**

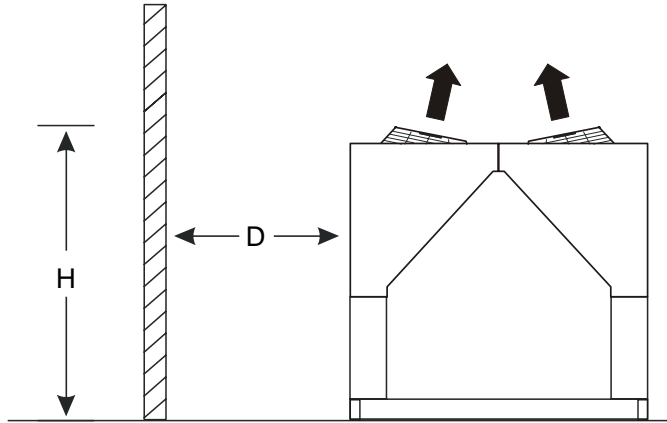

**Figure 16, Adjustment Factors**

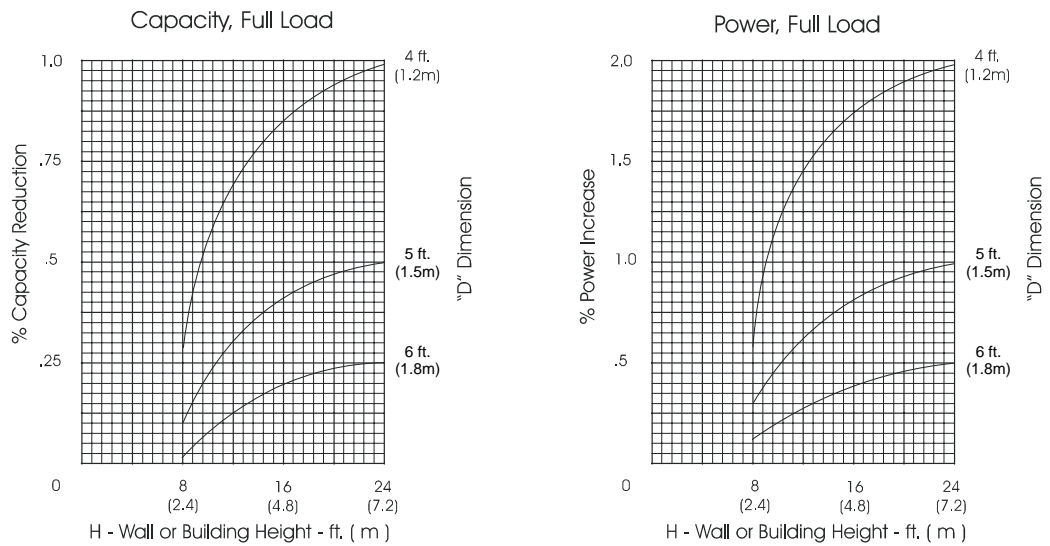

## Case 2, Two Units Side By Side

Two or more units sited side by side are common. If spaced closer than 12 feet (3.7 meters) it is necessary to adjust the performance of each unit; circuits adjoining each other are affected. If one of the two units also has a wall adjoining it, see Case 1. Add the two adjustment factors together and apply to the unit located between the wall and the other unit.

Mounting units end to end will not necessitate adjusting performance. Depending on the actual arrangement, sufficient space must be left between the units for access to the control panel door opening and/or evaporator tube removal. See "Clearance" section of this guide for requirements for specific units.

Pit or solid wall surrounds should not be used where the ambient air temperature exceeds 105°F (40°C).

**Figure 17, Two Units Side by Side**

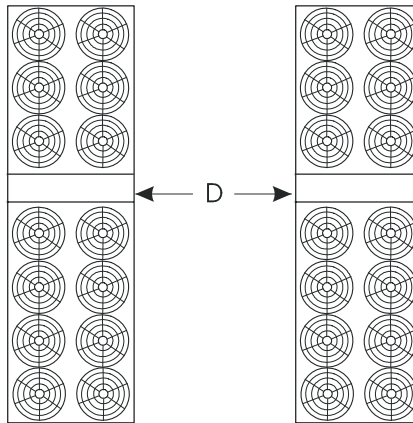

**Figure 18, Adjustment Factor**

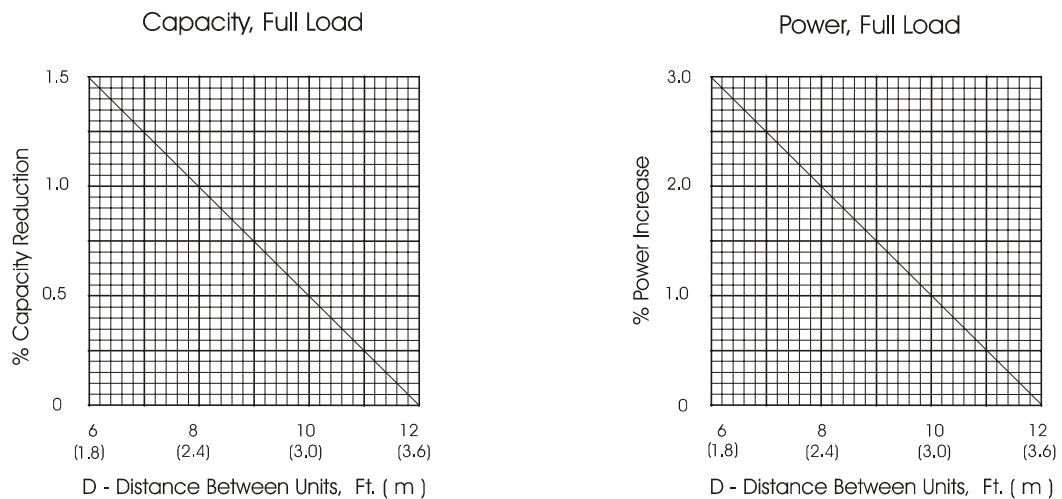

### Case 3, Three or More Units Side By Side

When three or more units are side by side, the outside chillers (1 and 3 in this case) are influenced by the middle unit only on their inside circuits. Their adjustment factors will be the same as Case 2. All inside units (only number 2 in this case) are influenced on both sides and must be adjusted by the factors shown below.

**Figure 19, Three or More Units**

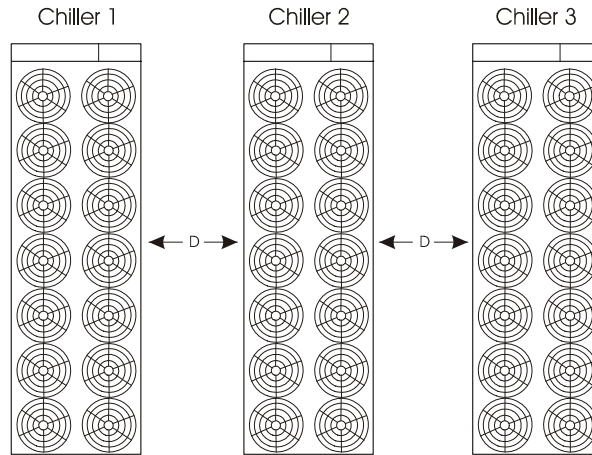

**Figure 20, Adjustment Factor**

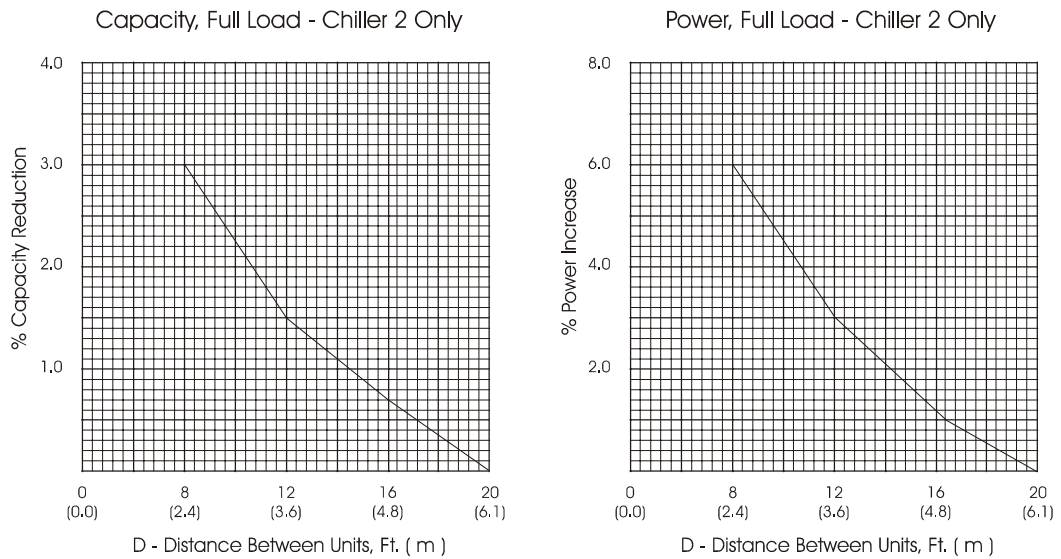

### Case 3, Open Screening Walls

Decorative screening walls are often used to help conceal a unit either on grade or on a rooftop. These walls should be designed such that the combination of their open area and distance from the unit do not require performance adjustment. It is assumed that the wall height is equal to or less than the unit height when mounted on its base support. This is usually satisfactory for concealment. If the wall height is greater than the unit height, see Case 4, Pit Installation.

The distance from the sides of the unit to the side walls should be sufficient for service, opening control panel doors.

If each side wall is a different distance from the unit, the distances can be averaged providing either wall is not less than 8 feet (2.4 meters) from the unit. For example, do not average 4 feet and 20 feet to equal 12 feet.

**Figure 21, Open Screening Walls**

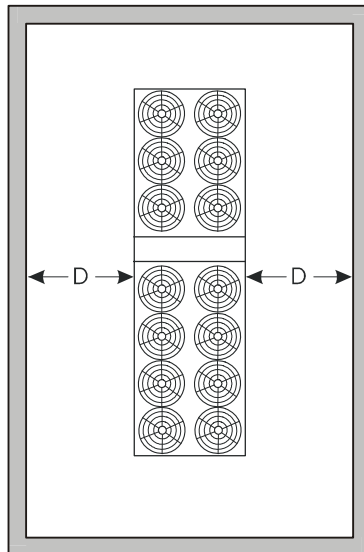

**Figure 22, Wall Free Area vs Distance**

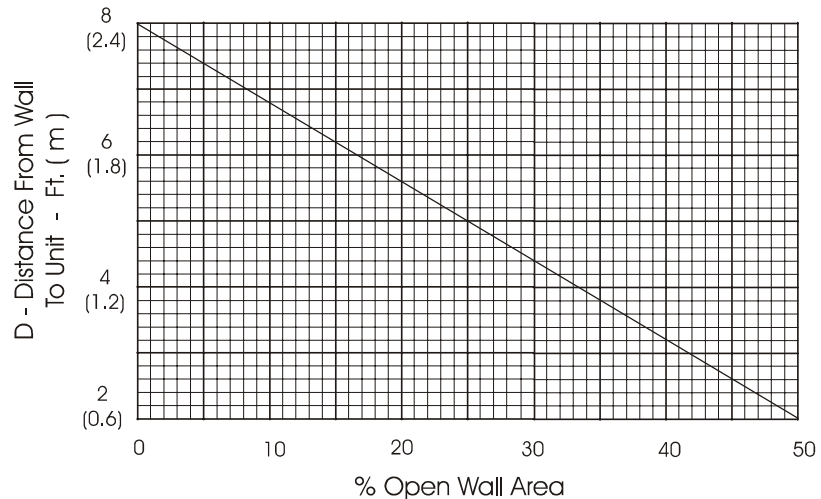



### Case 4, Pit/Solid Wall Installation

Pit installations can cause operating problems and great care should be exercised if they are to be used on an installation. Recirculation and restriction can both occur. A solid wall surrounding a unit is substantially the same as a pit and the data presented here should be used.

Steel grating is sometimes used to cover a pit to prevent accidental falls or trips into the pit. The grating material and installation design must be strong enough to prevent such accidents, yet provide abundant open area or serious recirculation problems will occur. Have any pit installation reviewed by McQuay application engineers prior to installation to make sure it has sufficient air-flow characteristics. The installation design engineer must approve the work to avoid an unreasonable risk of accident.

**Figure 23, Pit Installation**

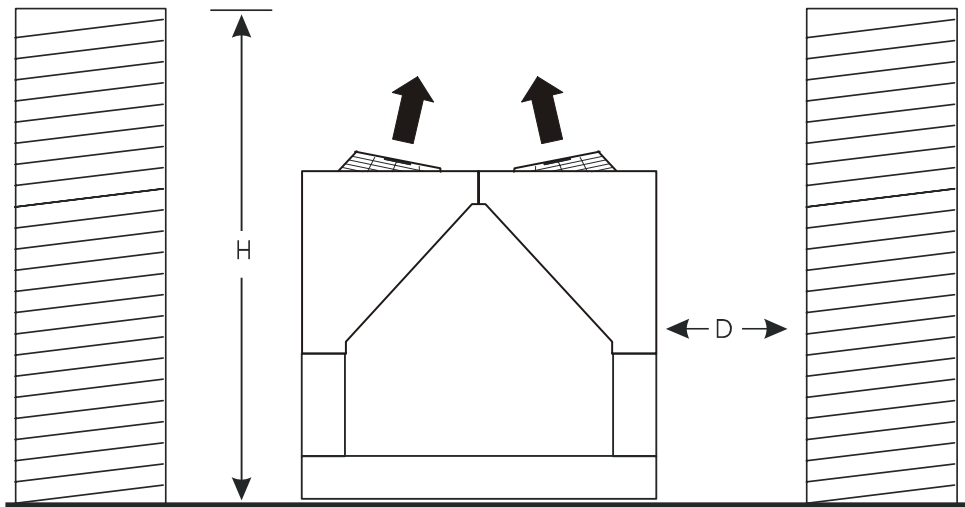

**Figure 24, Adjustment Factor**

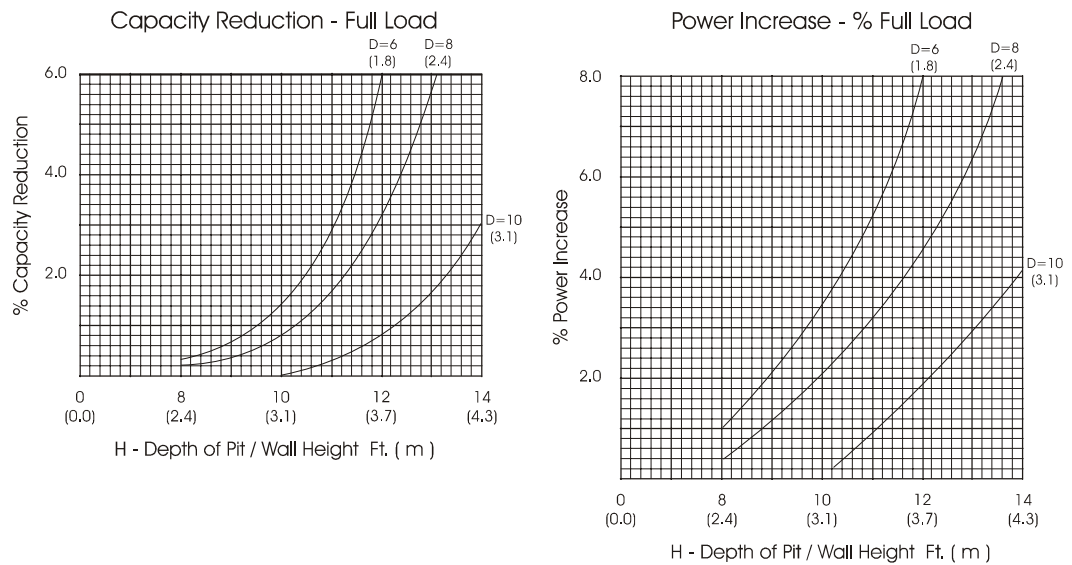

# Chilled Water Systems

---

McQuay requires that chilled water piping for its chillers be designed and installed in conformance with the system recommendations described in (American Society of Heating Refrigeration and Air-Conditioning Engineers, Inc.) ASHRAE Handbooks.

## Multiple Units

Chillers are frequently installed in multiple. Doing so provides standby reliability and improved performance, and is recommended. Multiplicity of machines however can result in unexpected problems where chiller controls or capacity reduction are overlooked in the design. Single chiller installations are equally susceptible to application oversight. The following offers supplemental information to that discussed in ASHRAE for the purpose of minimizing installation problems.

## Water Flow

Chilled water systems are normally designed with leaving chilled water temperatures of 40°F to 46°F (4.4°C to 7.8°C), a 10 degree F (6 degree C) water temperature difference and 0.0001 fouling factor. Catalog performance tables display data for the chillers at these conditions. Actual design can be different, and this catalog includes adjustment factors or special rating tables to account for other conditions.

1. Addition of secondary coolants such as ethylene glycol.
2. Variances from 10 degree F (5.5 degree C) water temperature differences.
3. Greater than standard water fouling.
4. Elevation and ambient air temperatures.

Specifications and start-up procedures should:

1. Confirm that the chilled water piping system had been properly flushed out before being connected to the chiller vessel.
2. Confirm that the piping contains:
  - a) A cleanable strainer to remove impurities before they reach the chiller vessel.
  - b) An expansion tank in the piping.
  - c) An air vent located at the system high point to purge trapped air in the piping system. A vent connection is also located in the water head of the flooded vessel evaporator and should have a vent if it is the high point in the system.

All water systems include air in solution with the water. The percentage of air that can be retained in solution is a function of the water temperature and water pressure. Since these two values change in both chilled and hot water systems, the presence of both "b" and "c" components listed above are vital to the successful operation of the system.

The presence of a cleanable filter or strainer (2a above) in a chilled water piping system is frequently taken for granted. The fact is that the filter or strainer may be inadequate for the installation or may be installed in the wrong location.

Many chiller installations today are replacements for older less efficient machines or chillers with CFC refrigerants. Existing piping is drained down, opened to atmosphere, and reconnected to the new chiller vessel. Rust formed over the years and during the replacement process can break loose, pass through a conventional strainer, and settle in the chiller vessel that is frequently the lowest point in the piping system. Not only is a higher capacity filter required for these installations, but chemical treatment of the water is recommended immediately and should be maintained throughout the equipment life.

**Figure 25, Typical Chilled Water Piping**

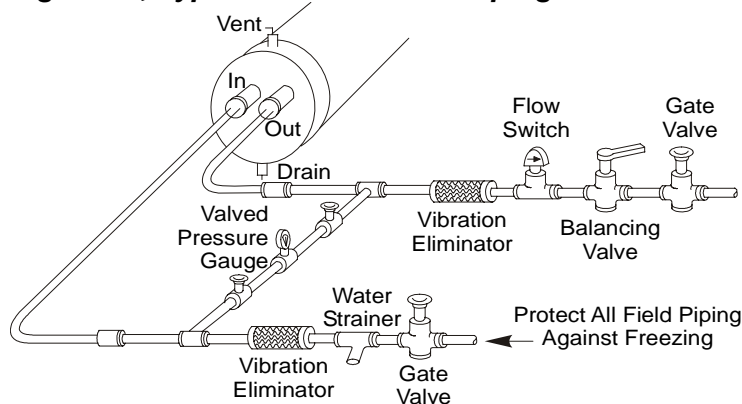

**Notes:**

1. Connections for vent and drain fittings are located on the top and bottom of both evaporator water heads.
2. Piping must be supported to avoid putting strain on the evaporator nozzles.

## Checking Water Flow

The simplest method of checking water flow in a clean system (the chiller vessel has not been fouled nor is air bound), is to read the entering and leaving pressures and compare the actual pressure drop to the value published in the product catalog.

Pressure drops at the job are read in psi or feet of water (kPa). Published values are displayed in feet of water. Use the following formula to convert from one to another.

$$2.31 \times \text{PSI} = \text{Feet of water}$$

*or*

$$\text{Feet of water} \times 0.433 = \text{PSI}$$

## System Water Volume

It is important to have adequate water volume in the system to provide an opportunity for the chiller to sense a load change, adjust to the change and stabilize. As the expected load change becomes more rapid, a greater water volume is needed. The system water volume is the total amount of water in the evaporator, air handling products and associated piping. If the water volume is too low, operational problems can occur including rapid compressor cycling, rapid loading and unloading of compressors, erratic refrigerant flow in the chiller, improper motor cooling, shortened equipment life and other undesirable occurrences.

For normal comfort cooling applications where the cooling load changes relatively slowly, we recommend a minimum system volume of three minutes times the flow rate (gpm). For example, if the design chiller flow rate is 600 gpm, we recommend a minimum system volume of 1800 gallons (600 gpm x 3 minutes).

For process applications where the cooling load can change rapidly, additional system water volume is needed. A process example would be the cooling of hot metal objects. The load would be very stable until the hot metal is dipped into the water tank. Then, the load would increase drastically. For this type of application, we recommend the normal comfort cooling recommendation addressed above plus three minutes of ballast for every 10% quick change in load. For example, if the hot-metal example load changes from a stable 50% load to an immediate 100% load for metal cooling, the recommended system volume would increase to 7600 gallons.

System volume = {600 gpm x 3 minutes} + {(5 increment of 10% increase) x (3 minutes) x 600 gpm} = 10,800 gallons

Since there are many other factors that can influence performance, systems can successfully operate below these suggestions. However, as the water volume decreases below these suggestions, the possibility of problems increases. We believe that these guidelines should be an industry standard and not just recommendations from McQuay.

## Freeze Protection

Flooded evaporators are popular with chiller manufacturers because of their inherent high efficiency. Care must be exercised in the equipment design and in the operation of these evaporators to prevent freezing between 32°F and -20°F.

For freeze protection down to 0°F (-18°C), the AGS chillers are equipped with thermostatically controlled evaporator heaters that help protect against freeze-up provided the chiller goes through its normal pumpdown cycle. Several occurrences can prevent this normal pumpdown from happening:

1. A power failure will prevent pumpdown and there is a potential for freezing outdoor equipment in systems using 100 percent water as the chilled fluid.
2. Unit shutdown due to a fault will cause immediate compressor shutdown without the pumpdown cycle. This situation can be remedied by correcting the fault, restarting the unit, and allowing it to go through its normal shutdown pumpdown.

The heaters come from the factory connected to the control power circuit. The control power (not just the heater power since the unit microprocessor must also be powered) can be rewired to a separate 115V supply. If this is done, the disconnect switch should be clearly marked to avoid accidental deactivation of the heater during freezing temperatures. Exposed chilled water piping also requires protection.

For additional protection to -20°F (-29°C) and to protect against the consequences described above, it is recommended that at least one of the following procedures be used during periods of sub-freezing temperatures;

1. Addition of a concentration of a glycol anti-freeze with a freeze point 10 degrees below the lowest expected temperature. This will result in decreased capacity and increased pressure drop.

---

**Note:** Do not use automotive grade antifreezes as they contain inhibitors harmful to chilled water systems. Only use glycols specifically designated for use in building cooling systems.

---

2. Draining the water from outdoor equipment and piping and blowing the chiller tubes dry from the chiller. Do not energize the chiller heater when water is drained from the vessel.



## CAUTION

**If fluid is absent from the evaporator, the evaporator heater must be de-energized to avoid burning out the heater and causing damage from the high temperatures.**

3. Providing operation of the chilled water pump, circulating water through the chilled water system and through the evaporator. The chiller microprocessor will automatically start up the pump if so wired.

**Table 31, Freeze Protection**

Temperature °F (°C)	Percent Volume Glycol Concentration Required			
	For Freeze Protection		For Burst Protection	
	Ethylene Glycol	Propylene Glycol	Ethylene Glycol	Propylene Glycol
20 (6.7)	16	18	11	12
10 (-12.2)	25	29	17	20
0 (-17.8)	33	36	22	24
-10 (-23.3)	39	42	26	28
-20 (-28.9)	44	46	30	30
-30 (-34.4)	48	50	30	33
-40 (-40.0)	52	54	30	35
-50 (-45.6)	56	57	30	35
-60 (-51.1)	60	60	30	35

**Note:** These figures are examples only and can not be appropriate to every situation. Generally, for an extended margin of protection, select a temperature at least 10°F lower than the expected lowest ambient temperature. Inhibitor levels should be adjusted for solutions less than 25% glycol.

## Chilled Water Pump

It is required that the chilled water pumps' starter be wired to and controlled by the chiller's microprocessor. The controller will energize the pump whenever at least one circuit on the chiller is *enabled* to run, whether there is a call for cooling or not. The pump will also be energized when the controller senses a near-freezing temperature at the chiller outlet sensor to assist in cold weather freeze protection. Connection points are shown in Figure 6 on page 31.

## Variable Speed Pumping

Variable water flow involves changing the water flow through the evaporator as the load changes. McQuay chillers are designed for this duty provided that the rate of change in water flow is slow and the minimum and maximum flow rates for the vessel are not exceeded.

The recommended maximum change in water flow is 10 percent of the change per minute.

The water flow through the vessel must remain between the minimum and maximum values listed on Figure 3. If flow drops below the minimum allowable, large reductions in heat transfer can occur. If the flow exceeds the maximum rate, excessive pressure drop and tube erosion can occur.

# Electrical Connections

All wiring must be done in accordance with applicable local and national codes.

AGS units can be ordered with standard multiple point power or optional single point connections. Wiring within the unit is sized in accordance with the U.S.A. National Electrical Code. Separate field-supplied or factory-supplied disconnects are required for each circuit.

**Table 32, Electric Power Connection Options**

AGS 230 - 320	AGS 340 - 475
Standard: 2 power blocks, no disconnect switches, no compressor isolation circuit breakers	Standard: 3 power blocks, no disconnect switches, no compressor isolation circuit breakers
Optional: 2 disconnect switches replacing the power blocks, no compressor isolation circuit breakers	Optional: 3 disconnect switches replacing the power blocks, no compressor isolation circuit breakers
Optional: 1 power block, 2 compressor isolation circuit breakers	Optional: 1 power block, 3 compressor isolation circuit breakers
Optional: 1 disconnect switch replacing the power block, 2 compressor isolation circuit breakers	Optional: 1 disconnect switch replacing the power block, 3 compressor isolation circuit breakers
Optional: 1 high interrupt disconnect switch, 2 compressor isolation circuit breakers, in a high short circuit rated panel	Optional: 1 high interrupt disconnect switch, 3 compressor isolation circuit breakers, in a high short circuit rated panel

**NOTES:**

1. Disconnect switches are molded case construction with lockable through-the-door handles. They can be used to remove the unit/circuit from the power system.
2. The individual compressor isolation circuit breakers for each circuit isolate the compressor and do *not* have through-the-door handles. They are operable only after the panel doors are opened.
3. The high short circuit rated panel means that a short circuit current up to the ratings shown in Table 33 will be contained in the panel. There is a short period of time when the circuit breaker will pass a short circuit before opening a circuit that can damage downstream components. In other words, the enclosure is stronger than a standard enclosure. It has a high interrupt rated disconnect switch(es).
4. The factory-mounted control power transformer is protected by fuses.
5. Condenser fans are protected and isolated by circuit breakers.

**Table 33, Interrupt Ratings (kAmps)**

VOLTAGE	STANDARD SHORT CIRCUIT PANEL RATING	HIGH INTERRUPT DISCONNECT SWITCH	HIGH SHORT CIRCUIT RATED PANEL
460	35 kA	100 kA	65 kA
575	10 kA	25 kA	25 kA

Disconnecting means are addressed by Article 440 of the U.S.A. National Electrical Code (NEC) which requires "disconnecting means capable of disconnecting air conditioning and refrigerating equipment including motor-compressors, and controllers from the circuit feeder." The disconnect switch should be selected and located within the NEC guidelines. Maximum recommended fuse sizes are given in the electrical data tables of this catalog for help in sizing the disconnect.

Terminals are provided in a unit control center for optional field hookup of the control circuit to a separate fused 115 volt power supply. A control circuit transformer is factory installed to eliminate the requirement for a separate power supply to the control circuit.

# Standard Features

---

## Full Factory Testing

Factory run tests with water hookups on all units prior to shipment help provide a trouble free start-up. Each unit is pressure tested, evacuated, and charged with a full operating charge of R-134a refrigerant and oil. McQuay performs extensive quality control checks and individual unit tests so that all controls are properly adjusted and operating correctly. Job site start-up and expenses are kept to a minimum as the unit is shipped ready to operate.

## Rigging

Designed for easy handling and low installation costs, the AGS air-cooled screw chillers are assembled on a rugged structural steel and painted base. The channel base distributes the unit weight for uniform low roof loading. Rigger preferred, lifting tabs with holes are provided in the base of the unit to simplify lifting. See dimension drawing for location.

## Construction

The structural steel base and G-90 galvanized steel structural members and sheet-metal casings are painted with a corrosion-resistant 500-hour salt spray paint (per ASTM B117). This finish enhances the appearance of the unit and deters corrosion.

## Compressors

All units feature multiple compressors with independent refrigerant circuits. The compressor is a direct drive, 3600-rpm, single-screw type with one main rotor that meshes with two diametrically opposed gaterotors. The two exactly opposed gaterotors create two opposed compression cycles resulting in a well-balanced compression cycle.

Unloading is modulated from 100 to 25 percent, depending on conditions, on each compressor. Each compressor is equipped with a discharge check valve downstream of the oil separator. An optional suction service shutoff valve is available.

## Evaporator

The evaporator is a flooded, shell-and-tube type with water flowing in the tubes and refrigerant boiling in the shell side. The vessel is divided vertically into multiple refrigerant circuits, one per compressor with liquid feed in the bottom and the suction gas connection on the top of each section.

The evaporator is constructed with a carbon steel shell and seamless high efficiency copper tubes. Roll expansion anchors the refrigerant tubes in the carbon steel end and intermediate tube sheets.

Water heads are constructed of carbon steel and are removable to permit access to the tubes from either end. For easy draining and venting of the shell, 3/8 inch vent and drain plugs are provided on the top and bottom of each head.

The evaporator is insulated with 3/4 inch thick vinyl nitrate polymer sheet insulation and provided with insertion heaters to help provide freeze protection down to 0°F (-17.8°C) ambient air temperature.

The evaporator insulation has a K factor of 0.28 at 75°F (24°C). The insulation is fitted and cemented in place. Double insulation is available as an option.

The shell side maximum working pressure is 200 psi (1379 kPa). The standard water side working pressure is 150 psi (1034 kPa) with 300 psi (2068kPa) available as an option. Victaulic connections are standard with an option for flanges. All evaporators are designed, constructed, inspected and stamped in accordance with the requirements of the ASME Boiler and Pressure Vessel Code.

## Condenser Fans and Motors

Multiple direct-drive propeller fans operate in formed bell shaped orifices at low tip speeds for maximum static efficiency and minimum noise and vibration. Each fan is protected by a heavy-gauge, close meshed PVC coated fan guard and is positioned within the unit cabinet for maximum protection against the elements.

The fan deck and fans are canted inward to help reduce air recirculation and improve condenser coil efficiency by providing more equal air distribution.

A heavy-duty, 3-phase TEAO motor with rain shield, VFD rated, with permanently lubricated ball bearings and inherent overload protection direct drives each condenser fan. Factory circuit breakers provide positive protection from short-circuiting.

Optional VFD head pressure control on the first two fans permits unit operation down to -18°C (0°F) ambient (balance of fans are staged on and off). However, since the actual minimum ambient can be dependent on wind conditions, wind baffles are also available.

## Condenser Coils

The condenser coils are constructed with internally enhanced seamless copper tubes arranged in a staggered row pattern and mechanically expanded into McQuay lanced and rippled aluminum fins with full fin collars. The fins have full drawn collars to completely cover the copper tube for protection against atmospheric corrosion and provide excellent heat transfer. An integral subcooler on the air inlet side provides sufficient subcooling to effectively reduce the possibility of liquid flashing and increase unit efficiency. Standard PVC coated wire mesh guards protect the coils.

## Control Centers

The AGS screw chiller is shipped with all operating and equipment protection controls, phase voltage monitor, control transformer and solid-state motor starting and protection equipment, all factory-wired, operationally tested, and ready for service. The solid-state starter provides:

Controlled acceleration	Electronic thermal overload	Stalled motor protection
Controlled deceleration	Over/under current protection	Single phase protection
Phase rotation protection	Current unbalance protection	High load current

Each compressor has its own controller and control panel. This provides an important reliability feature in that if one compressor's controller should malfunction, the other compressor(s) will continue to operate normally.

The controls for each circuit are located in a weather-resistant, hinged control center, with tool-locked doors to prevent unauthorized entry. The microprocessor controllers are located in a separate box within the main panel to separate it from power wiring and components.

## Power Connections

The standard power connection arrangement is multi-point. One feed to a power block on each circuit (2 or 3). No circuit breakers or disconnects.

## Microprocessor Control

The AGS chillers are equipped with the new McQuay MicroTech II™ controller, a new version of the very highly regarded MicroTech™ control family. The MicroTech II has all the features of previous controllers plus simplified Building Automation System interface with Protocol Selectability™. The control is described in more detail beginning on page 10.



# Optional Features

---

## Controls

### Low Ambient Head Pressure Control

Optional VFD head pressure control on first two fans permits unit operation down to 0°F (-18°C) ambient (balance of fans are staged on and off. However, since the actual minimum ambient can be dependent on wind conditions, wind baffles are also available. Selection of this option also requires the addition of the High Ambient Option to provide a heat dissipation means for the VFDs.

### Ice Storage

The unit is equipped with control logic to handle the low temperatures associated with thermal storage applications. Additional evaporator insulation is recommended.

### Water Flow Switch

(Part Number 01750330) A water flow switch is available for field installation in the chilled water piping to protect against evaporator freeze-up under low or no flow conditions. Terminals are provided in the unit control center for field hook up of the water flow detection switch. Installation of a flow detection device is required.

### High Ambient Operation

Option required for operation at ambient temperatures above 115°F (46°C) or when the unit is equipped with the VFD low ambient fan control option. The kit includes a thermostat controlled, panel ventilation fan and inlet grille with filter. The option can be ordered with any unit. Ordering a “High Efficiency” unit does not automatically include this kit, it must be ordered separately. Compressor loading and unloading is adaptively determined by system load, ambient air temperature and other inputs to the MicroTech II control algorithms.

### Building Automation System (BAS) Interface

This is the Protocol Selectability® option to the MicroTech II controller. The addition of this optional communications module to the standard unit controller enables the controller to communicate using standard protocols such as LONTALK®, Modbus® and BACnet® using any of the following data link layer options: BACnet MS/TP, BACnet/IP, BACnet Ethernet or LONTALK (FTT-10A). It is necessary to identify the data link layer that will be used when entering an order. The communications module can also be added later in the field to an existing controller.

### Remote Communication Panel

A remote panel, field wired to the unit controller, that provides remote viewing of operating parameters, clearing of alarms and changing of setpoints. See page 12.

### Alarm Bell

Field installed and wired to the control panel to provide remote alarm signal.

## Electrical

### Single-Point Power Block

A single power supply to a power block mounted in a box located on the unit's frame. Each circuit is factory-wired from the box to a power block in each circuit's power panel. See dimension drawings for the box location. Includes factory wiring to a circuit breaker located in each circuit's power panel. Multiple-point power block (one circuit per compressor) is standard.

### **Multi-Point w/Disconnect Switch**

Separate power supply to each circuit's power panel which is equipped with a disconnect switch with a through-the-door handle. Each disconnect switch can isolate its circuit for service purposes.

### **Single-Point w/ Disconnect Switch**

Single power supply to a factory-mounted disconnect switch. Includes factory wiring to a circuit breaker located in each circuit's power panel.

### **High- Short Circuit Current Protection**

The control panels and single point connection box (if ordered) will have the high short circuit current rating as shown below. A high interrupt circuit breaker is included. See Table 33 on page 53 for ratings.

### **115 Volt Convenience Outlet**

A 10.0 amp, 115-volt convenience outlet mounted inside the control panel is available as an option on all units. The outlet is located in the #2 circuit control box.

### **Lightning Arrestor per Compressor**

## **Unit**

### **Black Fin Coil**

Aluminum fin stock is precoated with a phenolic-epoxy coating with 1000 hour salt spray resistance (ASTM B117-90).

### **Copper Fin Condenser Coils**

Copper fin condenser coils are available as an option on all models.

### **Baked Epoxy Condenser Coil Coating**

*Electro Fin*<sup>™</sup> flexible dip and baked epoxy protective coating with 3000+ hour salt spray resistance (ASTM B117-90) is available on the condenser coils and coil frames. Provides protection against adverse environments such as salt air as found on seacoast applications and many chemical environments. The coating can be applied to copper or aluminum coils. Consult the local McQuay sales office for complete specification and chemical resistance chart.

### **Fan Discharge Chimneys**

Six-inch high fan discharge chimneys help direct discharge air vertically.

### **Protective Base Guards**

Optional factory installed wire mesh lower base guards provide protection for ground level installations. Coil guards are standard.

### **Wind Baffles/Hail Guard**

The presence of wind will have an adverse affect on any air-cooled chiller. Wind across a condenser coil will not allow a chiller to operate as efficiently, or possibly not even start, at low ambient temperatures. Wind in effect raises the minimum ambient temperature in which the chiller can operate. The AGS air-cooled chillers are available with field installed wind baffles which allow the chiller to operate effectively down to the ambient temperature for which it was designed.

Hail can have a damaging effect on the performance of an air-cooled condenser. As the finned area is flattened against the coil, restricting airflow, the efficiency of the coil is reduced.

If desired, the wind/hail guards can be purchased for only one side of a unit in cases where an adjacent wall provides protection.

## **Louvers**

Stamped metal louvers for the coil section (upper part of unit) or combined with lower louvers to cover the full height of the side of the unit, for field installation. They provide protection from hail and vandalism and add a decorative appearance to the unit.

## **Vibration Isolators**

Spring vibration isolators are available for field installation under the unit base frame on sound sensitive applications. Consult the local McQuay sales office for seismic isolation.

## **Water Connections**

Standard connections are 150 psi victaulic. Options include 300 psi victaulic, 150 psi flanges and 300 psi flanges. The water-side is designed and constructed to ASME standards but not stamped.

## **Evaporator Insulation**

Double evaporator thermal insulation is available and recommended for low fluid temperature applications.

## **Suction Butterfly Valve**

An optional factory-mounted suction butterfly shutoff valve is available to assist in isolating the compressor for service.

## **High Ambient Operation**

Option required for operation between 115°F and 125°F (46°C and 52°C). Compressor loading and unloading is adaptively determined by system load, ambient air temperature and other inputs to the MicroTech control algorithms.

## **Unit Sound Blankets**

Sound isolation of the oil separators and discharge lines to reduce unit sound levels per table on page 25.

# **Limited Warranty**

---

Consult your local McQuay Representative for warranty details. Refer to Form 933-43285Y. To find your local McQuay Representative, go to [www.mcquay.com](http://www.mcquay.com).

# Specifications

---

The specification is available in MSWord from the local McQuay sales office.

## **SECTION 15XXX**

### **AIR-COOLED ROTARY SCREW CHILLERS**

#### **PART 1 - GENERAL**

##### 1.01 SUMMARY

Section includes design, performance criteria, refrigerants, controls, and installation requirements for air-cooled rotary screw packaged chillers.

##### 1.02 REFERENCES

Comply with applicable Standards/Codes of ARI 550/590, ANSI/ASHRAE 15, ASHRAE 90.1 October 2001 requirements, and ASME Section VIII.

##### 1.03 SUBMITTALS

- A. Submit shop drawings and product data in accordance with specification requirements.
- B. Submittals shall include the following:
  - 1. Dimensioned plan and elevation view drawings, required clearances, and location of all field connections.
  - 2. Summary of all auxiliary utility requirements such as electricity, water, compressed air, etc. Summary shall indicate quality and quantity of each required utility.
  - 3. Single line schematic drawing of the power field hookup requirements, indicating all items that are furnished.
  - 4. Schematic diagram of control system indicating points for field connection. Diagram shall fully delineate field and factory wiring.
  - 5. Certification of factory run test signed by company officer.
  - 6. Installation manuals.

##### 1.04 QUALITY ASSURANCE

- A. Qualifications; Equipment manufacturer must specialize in the manufacture of the products specified and have five years experience with the equipment and refrigerant offered.
- B. Regulatory Requirements: Comply with the codes and standards specified.
- C. Chiller manufacturer's facility must be ISO registered.

1.05 DELIVERY AND HANDLING

- A. Chillers shall be delivered to the job site completely assembled and charged with refrigerant and oil by the manufacturer.
- B. Comply with the manufacturers instructions for rigging and handling.

1.06 WARRANTY

The refrigeration equipment manufacturer's warranty shall be for a period of one year from date of equipment start up but not more than 18 months from shipment. It shall cover defects in material and workmanship having proven defective within the above period-**OR**-describe extended warranty.

**PART 2--PRODUCTS**

2.01 ACCEPTABLE MANUFACTURERS

- A. Basis of Design - McQuay model AGS, including the standard product features, and all special features required per the plans and specifications.
- B. Equal Products - Equipment manufactured by [ENTER MANUFACTURER NAME HERE] may be acceptable as an equal. Naming these products as equal does not imply that their standard construction or configuration is acceptable or meets the specifications. Equipment proposed "as equal", must meet the specifications including all architectural, mechanical, electrical, and structural details, all scheduled performance and the job design, plans and specifications.

2.02 UNIT DESCRIPTION

Provide and install as shown on the plans, factory assembled, factory charged with R-134a, and factory-run-tested air-cooled rotary screw compressor packaged chillers in the quantity specified. Each chiller shall consist of multiple semi-hermetic screw compressors, flooded evaporator, air-cooled condenser section, control system and all components necessary for controlled unit operation.

2.03 DESIGN REQUIREMENTS

- A. General: Provide a complete rotary screw packaged chiller as specified herein and as shown on the drawings. The unit shall be in accordance with the standards referenced in section 1.02 and any local codes in effect.

- B. Performance: Refer to the schedule of performance on the drawings. The chiller shall be capable of stable operation to a minimum of 12.5 percent of full load without hot gas bypass. The unit shall be capable of operating to 35°F (4.4°C) –**OR-** 0°F (-18°F) ambient air temperature. Performance shall be in accordance with ARI Standard 550/590-98.
- C. Acoustics: Sound pressure levels for the units shall meet or be lower than \_\_\_\_ dBA on the overall “A” weighted sound pressure level. Measurements to be taken at full load at a distance of 30 feet (9.14 meters) from the side of the unit.

#### 2.04 CHILLER COMPONENTS

- A. Compressors: The compressors shall be semi-hermetic, single-screw type with one main helical rotor meshing with two opposed gaterotors. The gaterotors’ contact elements shall be constructed of a composite material designed for extended life. If a twin-screw compressor is used, the manufacturer shall provide an extended 5-year parts and labor warranty covering all moving parts due to the large bearing loads inherent with this design.  
Electric motors shall be two-pole, semi-hermetic, squirrel-cage induction type and cooled by suction gas.
- B. Evaporator: The evaporator shall be of the flooded type with carbon steel shell, and high efficiency finned copper tubes rolled into steel tubesheets. The evaporator shall be insulated with 3/4 inch (19mm) closed cell polyurethane insulation and heated with an electric heater in both heads to help freeze protection. The evaporator shall be designed, inspected, and stamped in accordance with ASME Section VIII requirements.
- C. Condenser: The condenser coils shall have seamless copper tubes mechanically bonded into plate type fins. The fins shall have full drawn collars to completely cover the tubes. A subcooling coil shall be an integral part of the main condenser coil. Condenser fans shall be propeller type arranged for vertical air discharge and individually driven by direct drive fan motors. Each fan shall be equipped with a heavy-gauge fan guard. Fan motors shall be totally enclosed, air-over, three-phase, direct-drive, 1140 rpm. Coils shall be protected by a vinyl coated, wire mesh guard.

- D. Refrigerant Circuit: The unit must have refrigerant circuits completely independent of each other with one compressor per circuit. Each circuit shall include an oil separator, electronic expansion valve, compressor suction shutoff valve, discharge check valve, liquid line shutoff valves, replaceable core filter-driers, sightglass with moisture indicator and insulated suction line.
- E. Unit casing and all structural members and rails shall be fabricated of continuous G90 galvanized steel and painted to meet ASTM B117, 500-hour salt spray test. The control enclosure and unit panels shall be corrosion resistant painted before assembly.
- F. Solid-State Motor Starters (for each compressor): Starter shall be designed using the current generation of reliable solid-state technology. Each starter shall provide controlled motor acceleration and deceleration, and shall extend protections covering the following conditions: phase rotation, electronic thermal overload, over/under current, stalled motor, single phase, high load current and current unbalance. Across-the-line or wye-delta starters are not acceptable. Acceptable solid-state starter manufacturers are GE, Cutler-Hammer, Benshaw or Reliance. The solid state starters shall be capable of self-diagnostics, metering, and have an LED display to include the following operating and fault messages:

Operating Messages:

Line voltage not present  
Voltage present, starter ready  
Motor accelerating  
Motor at full speed  
Motor at full speed, ramp time expired  
Stop command received, motor decelerating  
Thermal overload has reached 90% to 99%  
Thermal overload at 100%, motor stopped  
Thermal overload reduced to 60%, motor can restart  
Passcode enabled  
Passcode disabled  
Thermal overload content in percentage

Fault Messages:

System power not three phase  
Phase sequence incorrect  
Line frequency less than 25 Hz

Line frequency more than 72 Hz  
Excessive current unbalance  
Operating parameters lost  
No current after "Run" command  
Undercurrent trip occurred  
Overcurrent trip occurred  
Control power too low  
Motor stalled during acceleration  
External fault.

G. Microprocessor based control system: Weatherproof control panels shall contain the field power connection points, control interlock terminals, and control system. Power and starting components shall include factory fusing of fan motors and control circuit; fan motor contactors, inherent fan motor overload protection and unit power terminal blocks for connection to remote disconnect switch. Terminals shall also be provided for power supply to the evaporator heater circuit. Hinged access doors shall be tool-lockable. Barrier panels or separate panel sections are required to protect against accidental contact with line voltage when accessing the control system.

The system shall stage the unit based on the leaving water temperature. Equipment protection functions controlled by the microprocessor shall include high discharge pressure, loss of refrigerant, loss of water flow, freeze protection, and low refrigerant pressure. Controls shall include auto/stop switch, chilled water setpoint adjustment, anti-recycle timer, and digital display with water temperature and setpoint, operating temperatures and pressures, and diagnostic messages. The following features and functions shall be included:

1. The LCD type display shall have a minimum of 4-line by 20-characters with all messages in English. Units of measure will be I-P. Coded messages and LED displays are not acceptable.
2. Critical parameters shall have their own section of control and be password protected.
3. Resetting chilled water temperature by a remote 4-20 mA signal.
4. A soft-load function to prevent the system from operating at full load during the chilled fluid pulldown period.



5. Auto restart after a power failure without an external battery back-up or auxiliary power for maintaining program memory.
6. Safety shutdowns shall be date and time stamped with system temperatures and pressures recorded. A minimum of six previous occurrences shall be kept in a revolving memory.
7. Start-to-start and stop-to-start timers to provide minimum compressor off-time with maximum motor protection.
8. Lead-lag by manual selection or automatically by circuit run hours.
9. Discharge pressure control through intelligent cycling of fans.
10. Pro-active compressor unloading in response to high discharge pressure or low evaporator pressure.
11. Continuous diagnostic checks of unit operation to provide a pre-alarm signal in advance of a shutdown allowing time for remedial action to be taken.
12. Unit controller shall be compatible with standard BAS protocols.

Factory mounted DDC controller(s) shall support operation on a BACnet®, Modbus® or LONMARKS ® network via one of the data link / physical layers listed below as specified by the successful Building Automation System (BAS) supplier.

- BACnet MS/TP master (Clause 9)
- BACnet IP, (Annex J)
- BACnet ISO 8802-3, (Ethernet)
- LONMARKS FTT-10A. The unit controller shall be LONMARKS ® certified.

The information communicated between the BAS and the factory mounted unit controllers shall include the reading and writing of data to allow unit monitoring, control and alarm notification as specified in the unit sequence of operation and the unit points list.

For chillers communicating over a LONMARKS network, the corresponding LONMARKS eXternal Interface File (XIF) shall be provided with the chiller submittal data.

All communication from the chiller unit controller as specified in the points list shall be via standard BACnet objects. Proprietary BACnet objects shall not be allowed. BACnet communications shall conform to the BACnet protocol (ANSI/ASHRAE135-2001). Provided a BACnet Protocol Implementation Conformance Statement (PICS) along with the unit submittal.

## 2.05 OPTIONS AND ACCESSORIES

The following options are to be included:

- Nonfused service disconnect switch, factory mounted
- Single-point power connection
- Low ambient head pressure control to 0°F (-18°C), factory mounted
- Copper fin condenser coils
- Baked epoxy condenser coating
- Black fin - precoated fin option
- Chilled water flow switch to be field mounted by contractor in the chilled water line and field wired to terminals in the control panel.
- Spring vibration isolators for field installation
- Protective epoxy-coated wire mesh lower base guards
- 115 volt convenience outlet mounted in control panel
- Wind baffles and hail guards for field installation by installing contractor
- High fault short circuit current protection, to 65 kA at 480 volts
- Lightning arrestor per compressor
- 300 psi water side with victaulic connections
- 150 psi water side with flanged connections
- 300 psi water side with flange connections
- High ambient operation above 115°F
- Unit sound blankets
- Remote communication panel

## **PART 3 - EXECUTION**

### 3.01 INSTALLATION

- A. Install in strict accordance with manufacturer's requirements, shop drawings, and contract documents.
- B. Adjust and level chiller in alignment on supports.
- C. Coordinate electrical installation with electrical contractor.
- D. Coordinate controls with control contractor.
- E. Provide all appurtenances required to insure a fully operational and functional chiller.

### 3.02 START-UP

- A. Provide proper charge of refrigerant and oil.
- B. Provide Authorized Factory starting of chillers, and instruction to the owner on proper operation and maintenance.





This document contains the most current product information as of this printing. For the most up-to-date product information, please go to [www.mcquay.com](http://www.mcquay.com).

