

## 1992 Tranter PHE, Inc. Superchanger Plate Heat Exchanger

Mfg: Tranter PHE, Inc

Model: UX-216-UP-255

Stock No. 12.CA39.3

Serial No. 57396

1992 Tranter PHE, Inc. Superchanger Plate Heat Exchanger. Model UX-216-UP-255, S/N 57396. 316 Stainless steel plates: (255). Heat transfer area: Approx. 1000 sq ft. Max. flow: 1060 gpm. NBR gaskets. Design temp of 270° F. Design pressure: 150 psi. Test pressure: 195 psi. Chevron patterned plates are ideally suited for handling aqueous solutions. Fixed end ports: (2) 4 in. Movable end ports: (2) 4 in. Overall dimensions: 85-1/2 in. L x 25 in. W x 64 in. H.

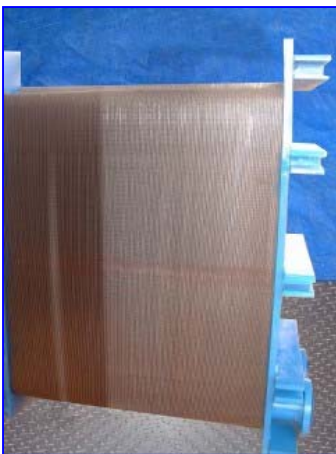
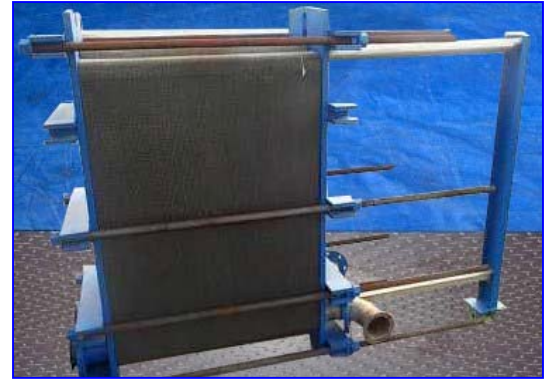
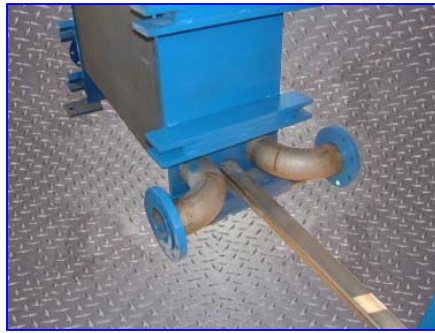
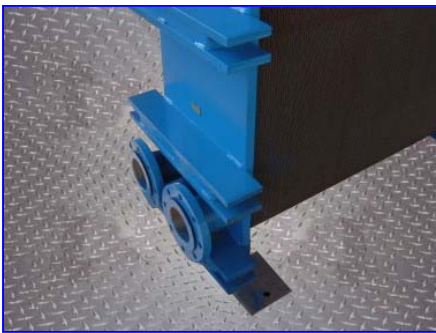
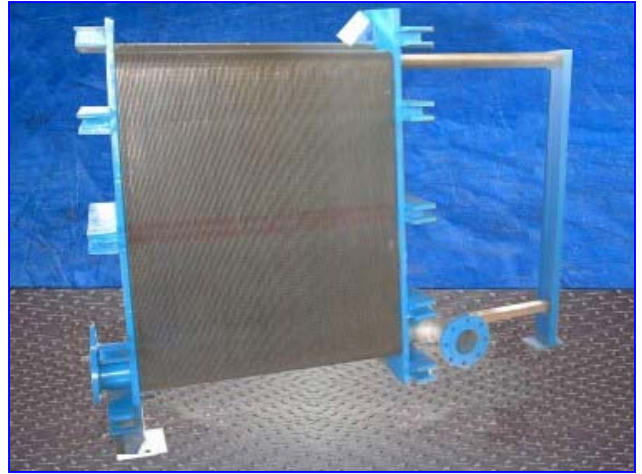



**SUPERCHANGER®**

P L A T E  
 F R A M E



## Engineered Heat Transfer Solutions For Typical Applications Around The World



- ▲ District Chilled Water Coolers
- ▲ Heating and Cooling Plating Solutions
- ▲ Waste Heat Recovery from Condenser Water
- ▲ Solar Collector Fluid Isolation
- ▲ Heat Recovery from De-inking Effluent
- ▲ Preheat Make-up Water in Photo Processing
- ▲ Welder Water Coolers
- ▲ Cooling Anodizing Solutions
- ▲ Heat Recovery in Co-generation Facilities
- ▲ Cooling Machine Oil
- ▲ Cooling Quench Oil
- ▲ Cooling Grinder Coolant
- ▲ Turbine Cooling in Power Plants
- ▲ Geothermal Water Isolation
- ▲ Lube Oil Cooling
- ▲ Cooling Engine Jacket Water
- ▲ Heating Ship Service Water
- ▲ Cooling Electronic Equipment
- ▲ Heating or Cooling Jacket Fluid for Chemical Reactors
- ▲ Heating of Electrolyte Solution in Copper Mills
- ▲ Jacket Water Cooling in Black Liquor Recovery Process
- ▲ Heating White Water in Paper Mills
- ▲ Hydraulic Oil Coolers
- ▲ Cooling Ammonia Liquor at Coke Plants
- ▲ Isolation and "Free Cooling" in HVAC
- ▲ Heating and Cooling Chemical Solutions
- ▲ Cooling Bleach Solutions
- ▲ Heat Recovery from Lean to Rich Amine Solutions
- ▲ Paint Coolers
- ▲ Heating Phosphatizing Solutions
- ▲ Acid Coolers
- ▲ Heat Recovery from Boiler Blowdown
- ▲ Heating and Cooling Kaolin Slurries
- ▲ Heating Wash Water
- ▲ Heating and Cooling Sugar Solutions
- ▲ Ethanol Distillation







# At the forefront of heat exchanger technology for over 60 years.



1

Tranter PHE is a global heat transfer company with representatives around the world. We are part of Tranter Inc. USA, a corporation of plate-type exchanger manufacturing companies, including SWEP CBE International AB, SWEP PHE and Tranter Radiator.

The Tranter Group has been at the forefront of plate heat exchanger technology for over 60 years and is part of Dover Corporation—a multi-billion dollar, NYSE-traded, Fortune 200 diversified team of companies—offering proprietary products and components for industrial and commercial applications around the world.

# Plate & Frame Heat Exchanger Technology

Tranter's commitment to superior plate-type heat exchanger design has established it as a leader in the selection and specification of a plate and frame heat exchanger for maximum performance and economy.

Tranter, inc. has been in the forefront of heat transfer technology, and has solved thousands of heat transfer problems in a variety of industries. Our complete engineering and manufacturing expertise brings you equipment that meets the highest standards of design excellence and quality workmanship.

Our specialists stand ready to show you how Tranter heat transfer technology can provide efficient, cost-effective solutions to problems arising from increased production and budget demands.

Sizing and specifying a heat exchanger to efficiently and economically satisfy a specific duty is somewhat more complicated than commonly envisioned. Many variables—design pressure, flow rate, pressure drop, nozzle velocity and material compatibility, among others—must be considered before the optimal unit for the specific requirement can be determined.

Optimum performance is a promise Tranter technical specialists have been fulfilling for many decades with SUPERCHANGER plate and frame heat exchangers.

## Plate & Frame For Maximum Efficiency

The SUPERCHANGER heat exchanger is designed to provide maximum efficiency in transferring heat from one liquid to another, or from steam to liquid.

It consists of a series of gasketed, embossed metal plates arranged alternately and bolted together between end frames to form channels through which hot and cold media flow. The hot fluid flows on one side of the plate while the cold fluid flows on the other, with the plate itself providing the most effective

Due to its high efficiency, the SUPERCHANGER unit can handle temperature approaches of less than 2°F. It also offers "U" values significantly greater (> 1500 Btu/hr ft<sup>2</sup> °F) than other exchangers, due to the unique turbulence created by its corrugated plates, which eliminates stagnant areas in liquid flow and promotes maximum heat transfer. This translates to a less expensive and more compact heat exchanger, occupying much less space.

The unit's velocity profile and induced turbulence causes dirty product deposits to be continually removed from the heat transfer surface during operation, thereby reducing fouling.

Effective use of the plate's turbulence can be made with in-place cleaning which allows back-flushing water or pumping cleaning solutions into the unit without disassembling. Units can

also be taken apart for cleaning the plate surfaces. Plates can be electropolished to make cleaning easier, either manually or in-place.

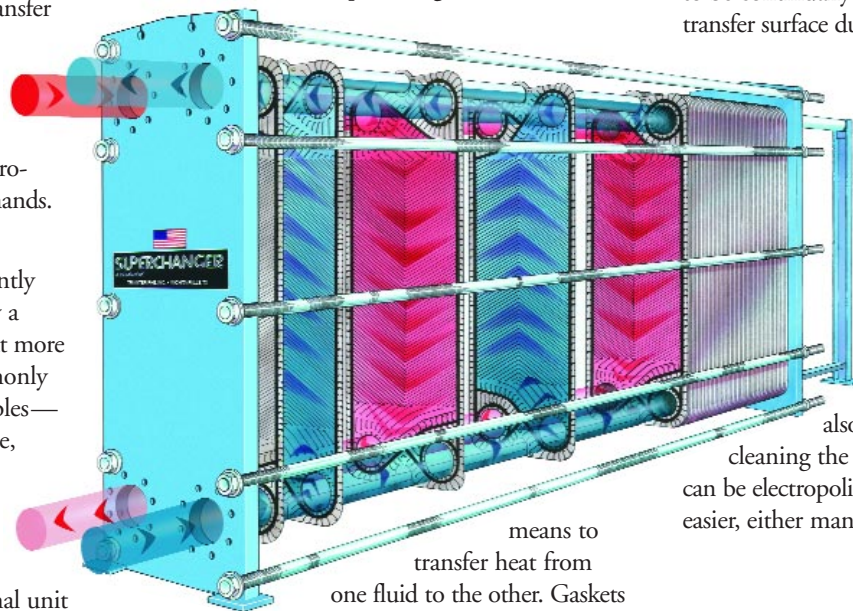

means to transfer heat from one fluid to the other. Gaskets mounted on the plates seal the channels and provide flow direction.

As liquids flow counter-currently through the channels between the plates, the cold liquid becomes warmer and the hot liquid cooler. Most units are designed for a one pass/one pass flow arrangement resulting in all nozzles being installed on the stationary end frame, which facilitates simpler piping arrangements and easier disassembly.

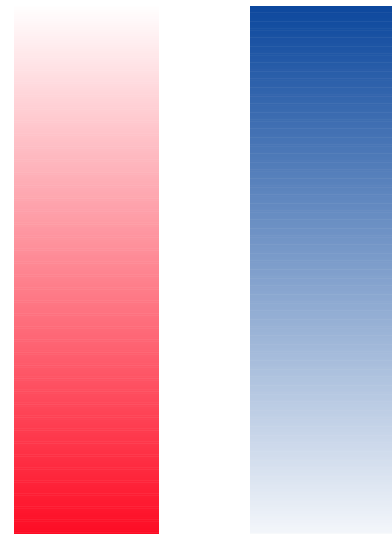

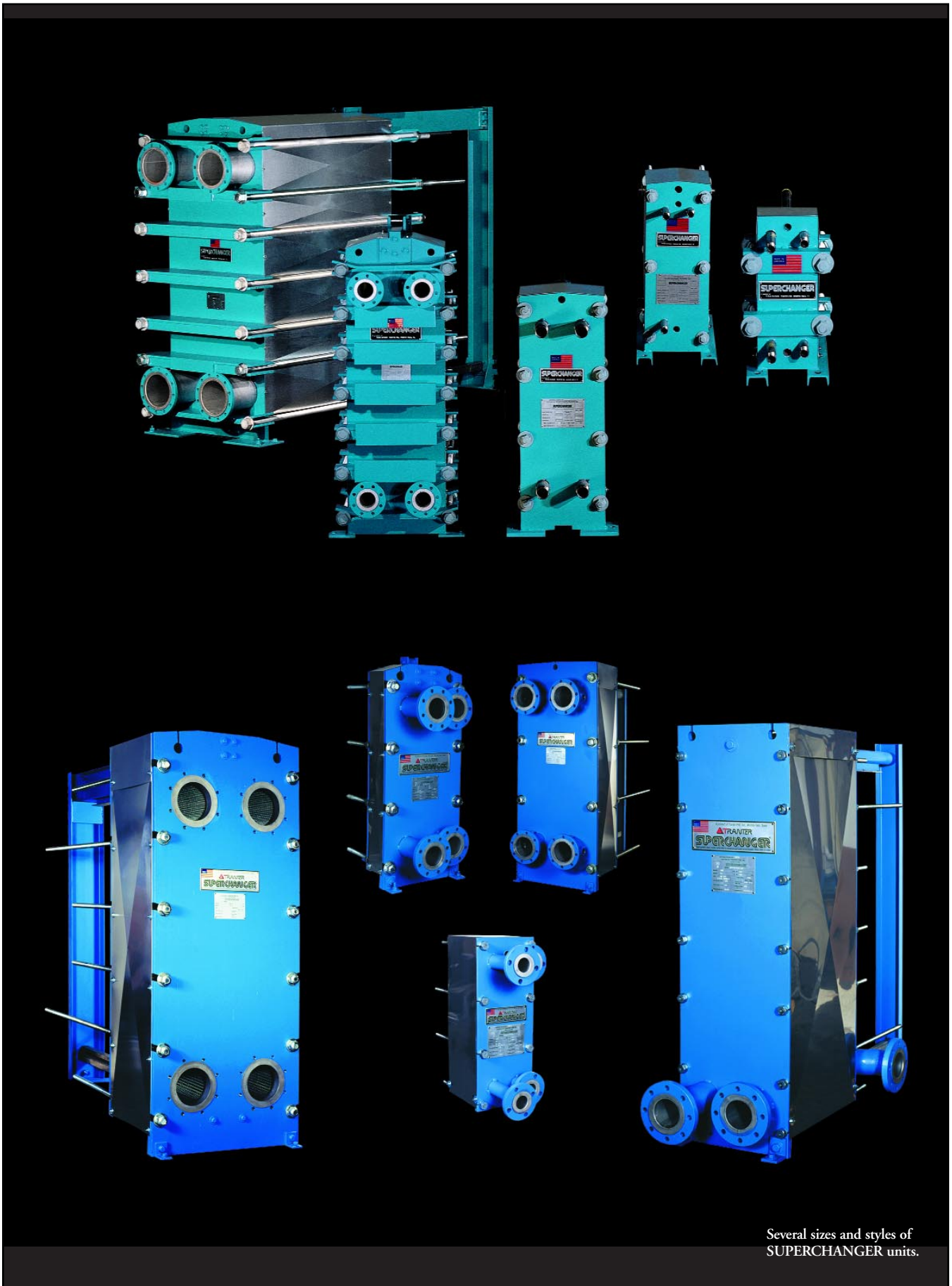

Several sizes and styles of SUPERCHANGER units.



# Efficient Heat Transfer For Every Industry

Efficiency, cost effectiveness, high performance, minimal maintenance and service are demanded by every industry and commercial or governmental entity in today's highly competitive, technological world.

Plate and frame heat exchangers have demonstrated their superiority in satisfying these demanding needs over other types of heat exchangers—and the best of plate and frame are Tranter's SUPERCHANGER units.

SUPERCHANGER heat exchangers are daily performing critical duties in a wide variety of applications around the world.

Stainless steel and high alloy plates in SUPERCHANGER units are performing extensive duties in chemical and petrochemical plants. Titanium plates on space saving shipboard units are being utilized in a variety of seawater cooling duties.

SUPERCHANGER units are effectively being used for electrolyte heating and cooling rolling mill coolants in a basic metals operation. Giant units are delivering efficient district cooling for office buildings in major metropolitan areas.

Heating, cooling and heat recovery applications in a wide array of industries include, but are not limited to:

- automotive production
- chemical processing
- food processing
- HVAC operations
- offshore oil and gas production
- oil and gas processing
- onboard marine vessels
- power generation
- steel and other metal production
- pulp and paper mills
- textile plants
- pharmaceutical
- mining
- grain distilling

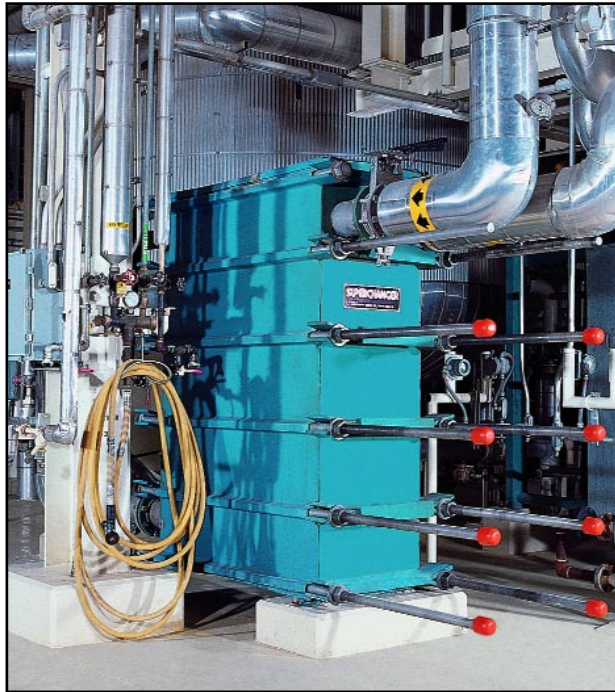

Pictured here is a SUPERCHANGER heat exchanger performing one of hundreds of duties in the food processing industry, which include process heating or cooling (many with viscous fluids), basic water heating and heat recovery from waste streams.



SUPERCHANGER heat exchangers recover heat very efficiently because of their high heat transfer rates and close temperature approach capabilities.



Thousands of SUPERCHANGER heat exchangers are in HVAC service for free cooling and isolation purposes. Free cooling payback is typically less than one year.

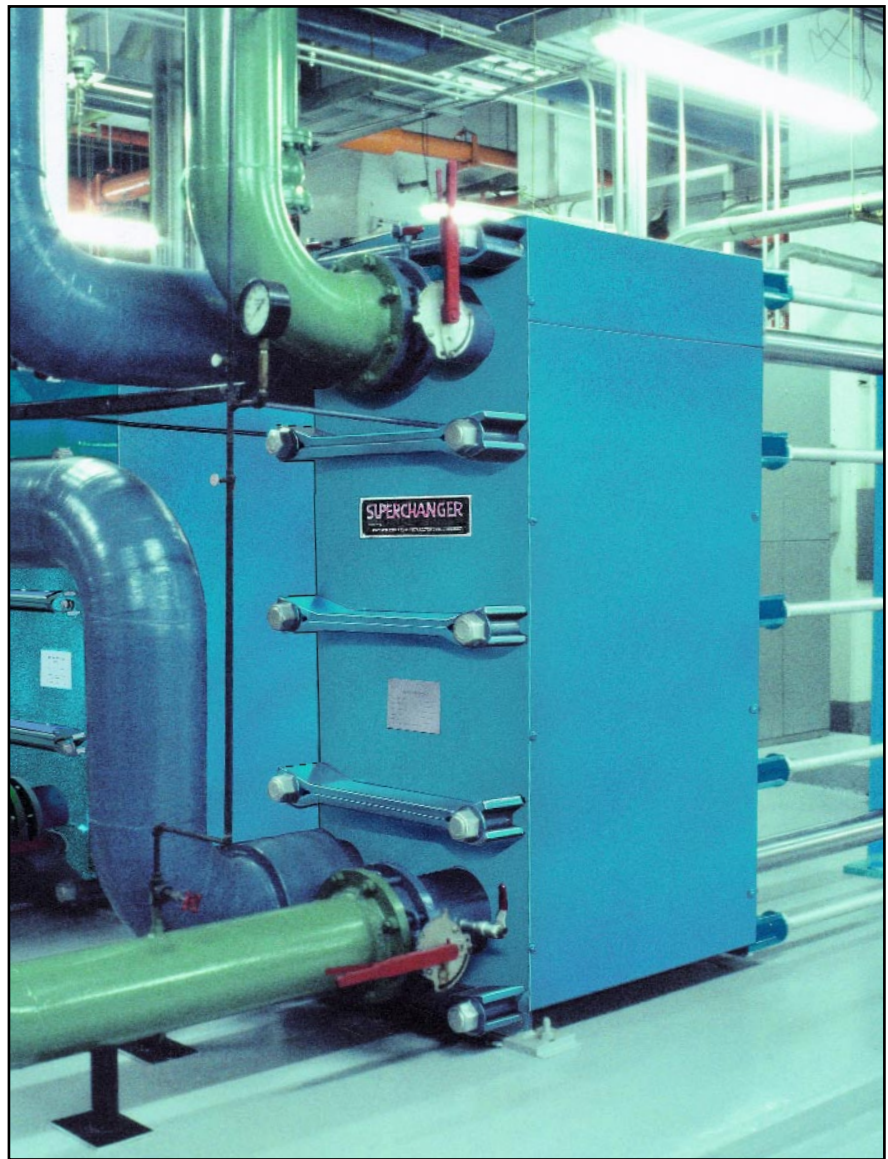

Two SUPERCHANGER units—installed in a bypass circuit so that the chillers can be shut down whenever outside temperatures drop below 45°F—have reduced energy consumption up to 57% in a major Southeastern high-rise complex. Included in the complex are one hotel, two towers, three condominium buildings, one large mall and a number of small buildings.



The large SUPERCHANGER units shown here cool closed-loop water which is used in cooling automatic welding machines. Other major automotive applications are heating wash, phosphate and rinse solutions, and temperature control of paint, plating solutions, etc.

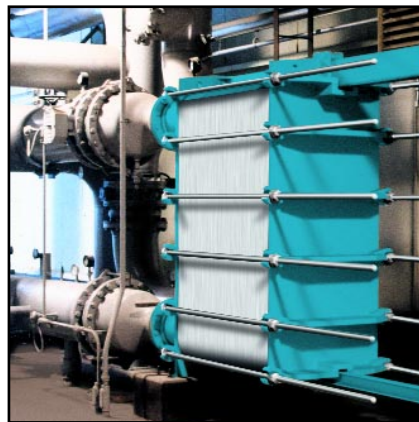

Primary power applications involve cooling of condensate, turbine bearing oil, ash handling systems, oil sumps, etc. Many duties include secondary exchangers to a central cooling unit.

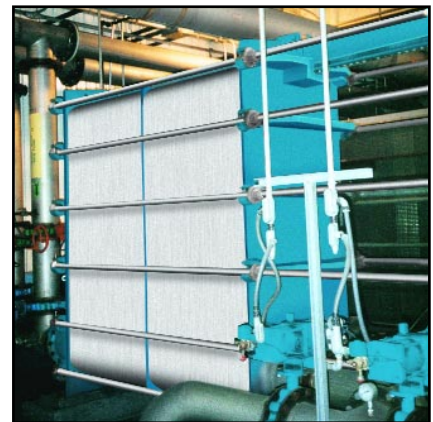

Cooling bleach solutions, digester heat recovery, cooling white water and heat recovery from boiler blow down are some of the numerous applications in the pulp and paper industry.



# Precise Plate Selection

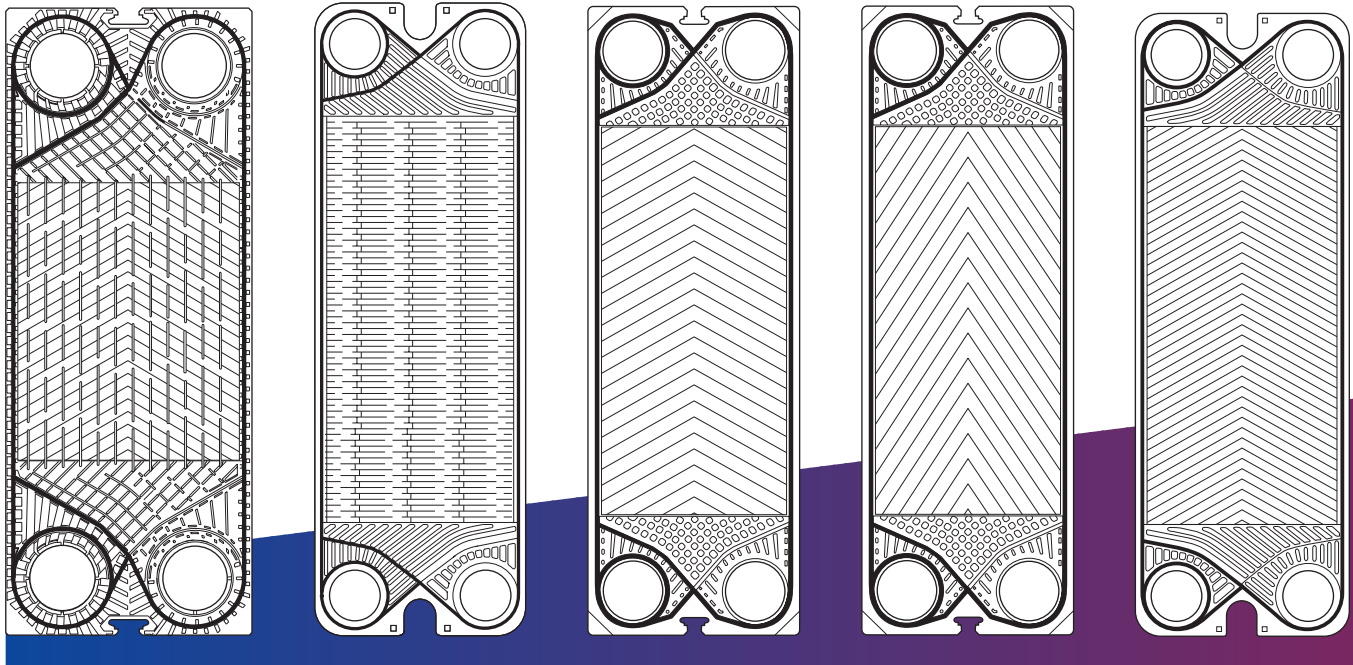

6

- ▲  
GFP  
Wide-Gap Series
- ▲  
GFP  
Washboard
- ▲  
GCD-High NTU  
Series
- ▲  
GCD-Low NTU  
Series
- ▲  
UXP-Series  
Herringbone  
High NTU

## GFP-Wide-Gap Plates

Wide-Gap plates are most effective in applications which involve viscous fluids or solids and slurries. These normally cause extensive clogging and downtime for cleaning with standard plate and frame or shell and tube heat exchangers. Our plates have a draw depth two to five times greater than conventional plates, permitting unrestricted passage of coarse particles and fibers.

Plates can be arranged in a wide/narrow configuration when only one fluid with large particulates requires a wide gap, or placed in a medium/medium position when both fluids need the additional

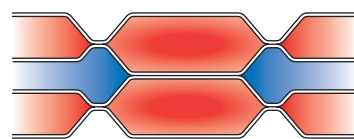

Wide/Narrow

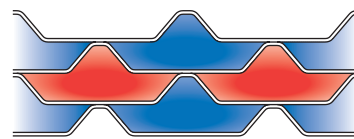

Medium/Medium

flow area. Both configurations are accomplished with a single plate geometry.

Wide-Gap plates are excellent for steam applications as well.

## GFP Washboard

Washboard plates, with corrugations in a washboard pattern, are used in numerous applications involving viscous liquids and solutions containing solid particles. They handle larger particle sizes than herringbone plates and are less prone to particulate fouling because of fewer metal-to-metal contact points and a wider interspace clearance.

## GCD-Series Plates

The latest GCD High NTU, and Low NTU, plates feature an innovative redesign of the flow distribution area, and are very suitable for both steam and viscous fluid applications requiring high heat transfer rates, at low pressure drops.

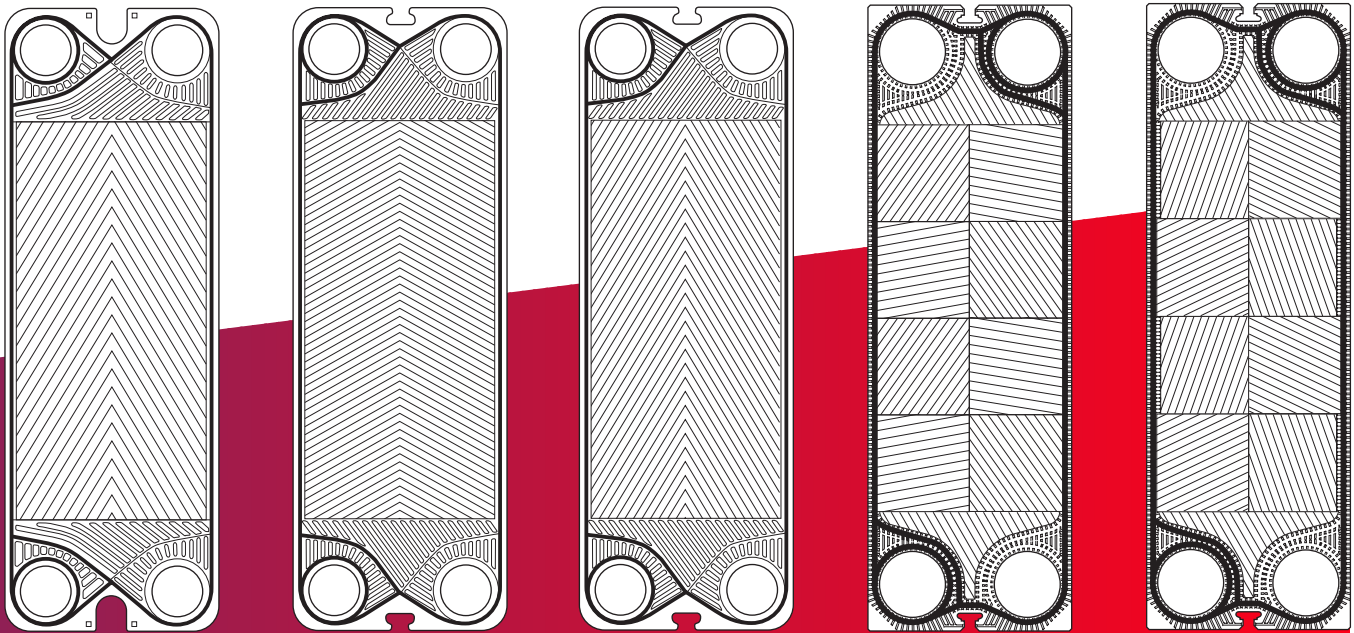

▲  
 UXP-Series  
 Herringbone  
 Low NTU

▲  
 SXP-Series  
 Herringbone  
 High NTU

▲  
 SXP-Series  
 Herringbone  
 Low NTU

▲  
 GXD-Series  
 High NTU

▲  
 GXD-Series  
 Low NTU

## UXP-Series Plates

UXP-Series plates have corrugations in a traditional herringbone or chevron pattern, offering a variety of thermal lengths. They are used in a multitude of applications, and are generally more efficient with relatively clean solutions due to greater induced turbulence within the flow stream.

## SXP-Series Plates

SXP-Series plates complement UXP plates. Their tighter pitch and smaller interspace clearance generate greater “U” values and higher pressure ratings.

## Mixed Plates

In many applications, better heat transfer performance can be achieved by units with mixed High and Low NTU plates having varying angles. In these duties, fewer plates are required because thermal and hydraulic requirements can be almost exactly matched.

## GXD-Series Plates

Especially when flows are unbalanced and the allowable pressure drops are reasonably close, Tranter utilizes its GXD-Series plate designs. Better accommodation of unequal flow rates, which optimizes pressure drop and heat transfer rates for both fluids,

furnishes the best overall system efficiency and results in a lower cost unit.

GXD plate technology utilizes two asymmetrical plate patterns to create six different flow channel configurations. And, with more than one hundred available plate combinations, we can better fit your specific heat transfer needs.

## A Variety of Sizes

The plate data chart on page 8 illustrates the multitude of sizes available in each series.



# A Wide Range of Choices

The broad range of materials currently available for SUPERCHANGER plate and frame heat exchangers provides a diverse selection for meeting an exceptionally wide variety of individual needs.

## Plate Choices

SUPERCHANGER plates are pressed in Wichita Falls, Texas, and produced in virtually any metal that can be cold-formed, including stainless steels (304, 316, 317, etc.), titanium, Monel®,

nickel, alloys 825, 20Cb-3, B-2, C-276, and a variety of other materials.

Plates are available in sizes ranging from .34 sq. ft. to 36.27 sq. ft., and in thicknesses from 0.5mm (0.020 in.) to 1.0mm (0.039 in.).

Table 1 Plate Data

Model	GCD-12	UXP-005	GXD-006	GCP-028	GCD-030	UXP-001	GXD-012	GXD-013	GCD-050	GXD-016	GCP-010	GXD-018
Heat Transfer Area Per Plate(ft <sup>2</sup> )	.34	.64	.75	.86	.91	.94	1.29	1.29	1.35	1.45	1.46	1.94

Model	UXP-100	GCP-026	GXD-026	GFP-030	GXD-037	UXP-200	GXD-042	GFP-050	GCP-051	GXD-051	GCP-060	GXD-060
Heat Transfer Area Per Plate (ft <sup>2</sup> )	2.15	2.91	2.91	3.40	3.98	4.04	4.74	5.32	5.92	5.92	6.03	6.03

Model	UPX-060	GXD-064	SXP-070	GFP-080	UXP-400	GCD-010	SX-40	GXD-085	GXD-091	GXD-100	UXP-110
Heat Transfer Area Per Plate (ft <sup>2</sup> )	6.10	6.89	7.24	7.60	8.20	8.97	9.70	9.80	9.80	10.87	11.80

Model	GXD-118	SXP-014	GXD-140	GXD-145	GFP-180	UXP-80	GXD-180	GXD-205	UXP-960	GXD-265	GXD-325
Heat Transfer Area Per Plate (ft <sup>2</sup> )	12.70	13.69	15.72	16.47	16.80	18.30	20.56	23.04	28.7	29.71	36.27

**TRIAL UNITS**—SUPERCHANGER units are available on a 90-day, no-charge basis for customer in-plant testing and evaluation. Contact your Tranter representative for information on the SUPERCHANGER trial unit policy.

## Frame Choices

Tranter offers both solid and reinforced end frames which can be ASME Code stamped up to a design pressure of 400 psig. Standard frames are constructed with baked epoxy enamel painted carbon steel, zinc plated tightening bolts and aluminum shrouds. Compact versions with no support column are available on some units. Stainless steel tightening bolts and connecting frames are optional.

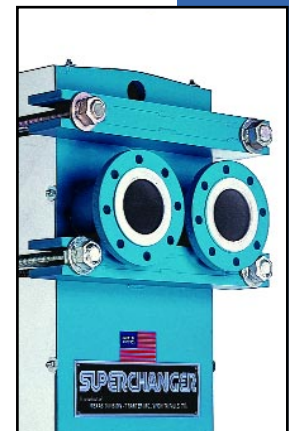

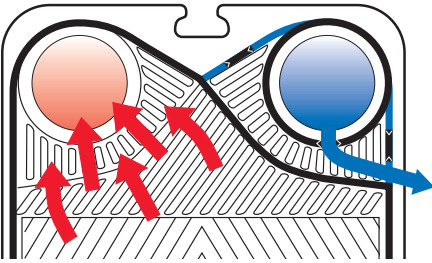

### No Cross-contamination With Gasket/Bleed Port Design

Due to the gasket/bleed port design, fluids will not intermix (other than a through-plate failure) when the plates are properly gasketed and the unit is assembled in accordance with prescribed instructions and design specifications. Liquid flowing on the surface of each plate flows on the inside of the boundary gasket. Should one of the liquids leak beyond a boundary gasket, it will flow to the outside of the unit through the bleed ports, preventing intermixing.

### Gasket Choices

SUPERCHANGER plate gaskets are specially molded elastomers to assure superior performance.

Numerous gasket materials—NBR, EPDM, Viton, Neoprene, Butyl, Hypalon, Teflon-encapsulated NBR and others—are available to match your process conditions, to maximum operating temperatures of 366°F.

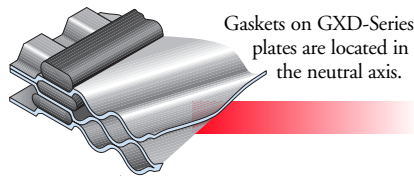

Gaskets on GXD-Series plates are located in the neutral axis.

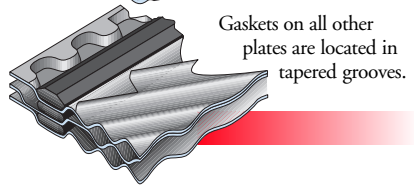

Gaskets on all other plates are located in tapered grooves.

Fully glued or SPOTGLUED® gaskets, which require less downtime to install, remove or clean, can be specified for most units. SUPERLOCK® glueless gaskets are available on several models.



SPOTGLUED gaskets



SUPERLOCK gaskets

### Nozzle Choices

Tranter offers ASA loose flange type nozzles as standard on reinforced end frames, and studded port connections as standard on solid end frames.

In addition, threaded pipe, sanitary and Victaulic connections are available.

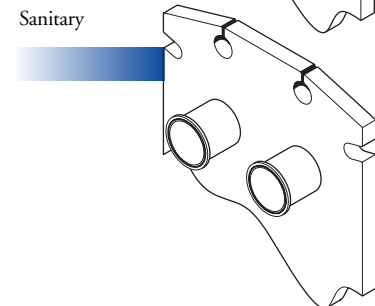
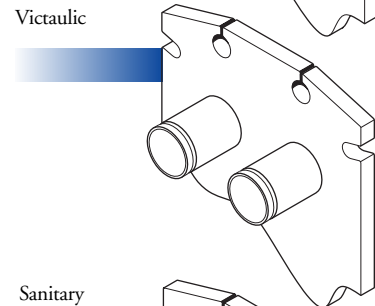
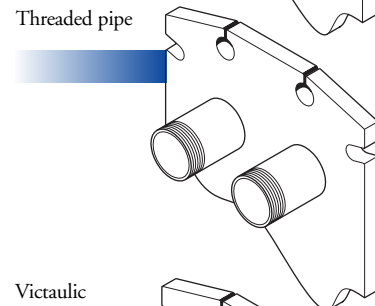
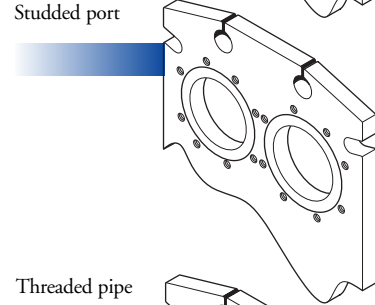
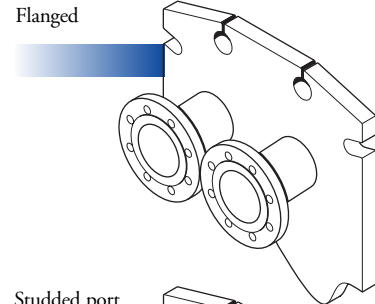



# World-class Manufacturing, Superior Testing and Servicing

## ISO 9001 Certification

Tranter–Texas Division is ISO certified, adhering to the highest standards in designing, manufacturing and testing SUPERCHANGER plate and frame heat exchangers.

SUPERCHANGER heat exchangers are computer designed and analyzed by technical specialists who generate a complete proposal providing optimum designs and alternatives. Quotations are prepared on a timely basis with all technical information required for evaluation.

SUPERCHANGER unit components are manufactured by state of the art production technology, and assembled by the most knowledgeable, experienced craftsmen using the best equipment and fabrication techniques available.

Tranter can custom-design a unit with the specific number, size, material and configuration of plates to meet your exact needs. If your needs change, the unit can be easily modified by simply adding or removing plates.

## Each Unit is Thoroughly Tested

After assembly, each SUPERCHANGER unit is hydrostatically tested, both single and double sides, at the required test pressures.

A number of additional tests, including process simulation and fatigue tests, can be performed to guarantee a unit fills your strict operational requirements.



GTAW and GMAW welding processes are utilized on nozzles and end frame reinforcing bars, respectively.



Many high precision tools are manufactured in-house.



A modern, fully equipped lab offers a wide range of tests.



Draw depths of plate chevrons are meticulously monitored.



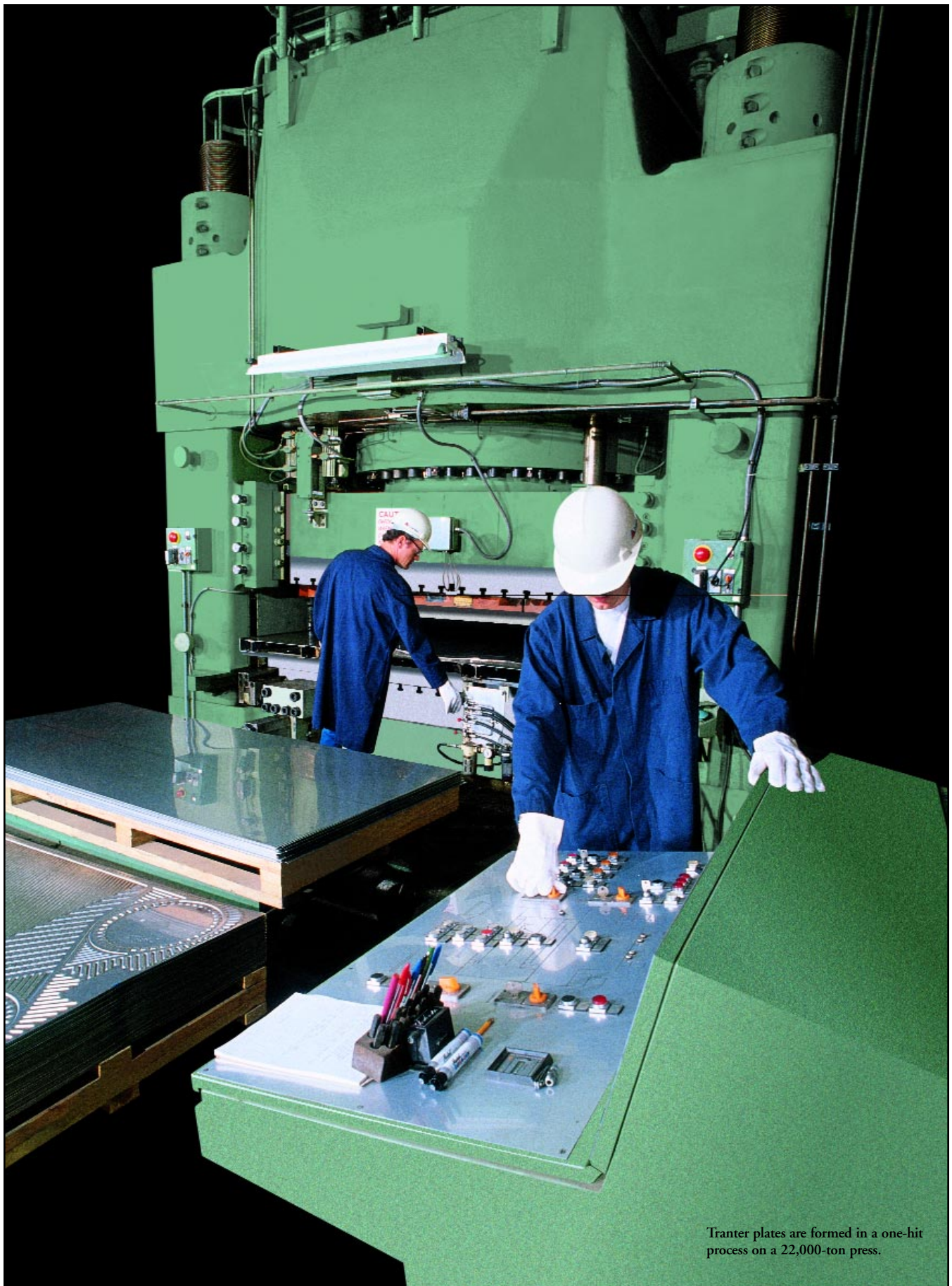

Tranter plates are formed in a one-hit process on a 22,000-ton press.



# How SUPERCHANGER PHEs Outperform Shell and Tube Units

SUPERCHANGER heat exchangers transfer heat more efficiently than shell and tube units in most applications, due in large measure to the turbulent flow created by the corrugated patterns of their plates.

They can pack greater than 22,000 sq. ft. of super efficient heat transfer surface in a single unit with flow rates up to 25,400 gpm.

They use only 10% to 50% of space required by shell and tube units, and are much lighter in weight.

And, they cost less.



12

## Side-by-Side Comparison:

**SUPERCHANGER  
Vs.  
Shell and Tube**

- “U” values several times greater than shell and tube
- Can be designed for less than a 2°F temperature approach
- Opens for access within its own footprint
- Easy disassembly—simply loosen bolts and roll movable frame back to the support column to remove plates
- Low fouling due to corrugations and inherent turbulence
- Intermix between fluids virtually impossible due to gasket design
- Practically no heat loss—no insulation required

- Low efficiency
- Typically designed for greater than a 5°F to 10°F temperature approach
- Requires twice its length to pull tube bundle
- Complex disassembly—tube bundle must be pulled
- 3 to 10 times greater fouling due to circular cross-section and channeling
- Fluids can intermix, both at welds and at tube sheet
- Great amount of heat loss—insulation required

# Plate Heat Exchanger Accessories



**Clean in Place Systems**  
Clean in Place (CIP) systems are available in standard and custom sizes.

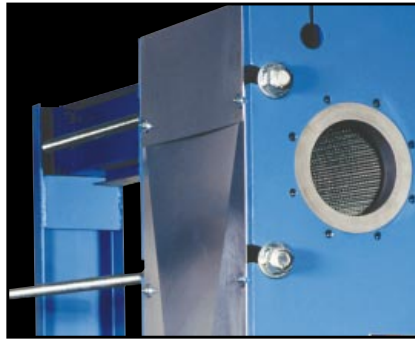

**Shrouds**  
Personnel or unit protection in an aggressive environment.

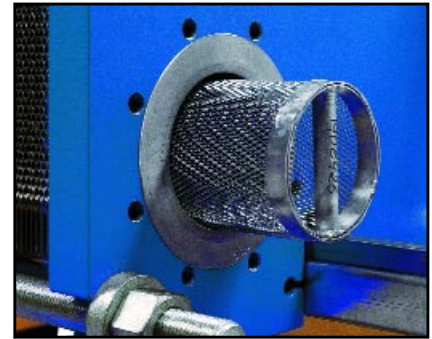

**Port Strainers**  
A strainer makes cleaning and inspection possible without dismantling the pipes. The length is adapted to the number of plates.



**Instruments and Gauges**  
Special flanges are available with outlets for drainage and ventilation, pressure gauges and sensors.



**Hydraulic Opening Devices**  
Makes assemble and reassemble of the heat exchangers fast, easy and secure.

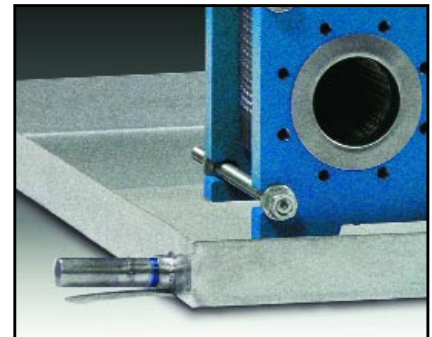

**Drip Pans**  
Preventing water and other liquids from floating on to the floor when dismantling the heat exchanger.

## Other Accessories Include:

- ▲ Backflush Valves
- ▲ Wrenches
- ▲ Grounding Lugs
- ▲ Molybdenum Bolt Coatings
- ▲ Tie-rod Protectors
- ▲ HexWrap Insulation
- ▲ Insulated Shrouds



# Other Tranter Plate Heat Exchanger Products & Services



## SERVICE CENTERS

At Tranter authorized service centers, we safely clean and regasket your heat exchanger plates, returning them to peak efficiency, and guarantee our work with our own written warranties covering materials and workmanship.

With Tranter PHE and its authorized service facilities, you can always be sure that you get the right gaskets, the right plates, the friendliest service and our OEM Guarantee. Give us a call at 1-800-414-6908.

## SUPERMAX™

The SUPERMAX all-welded plate heat exchanger handles liquids, gases and two phase mixtures at pressures to 600-plus psig and at very low and high temperatures. Nozzle sizes up to 6" can be accommodated on the shell side of the exchanger, offering higher steam and liquid flow rates. It can be fabricated from dissimilar metals when only one side will be exposed to corrosive conditions.



## ULTRAMAX™

The ULTRAMAX all-welded heat exchanger incorporates the efficiencies of a plate and frame heat exchanger without gaskets. It can operate at very high pressures (maximum design pressure 1,400 psig) and at low and high temperatures (-320°F to 650°F). It can handle liquids, gases and mixtures of the two. Special alloy construction is available, allowing it to be used with aggressive media. Various plate chevron angles offer flexibility in optimization.



## MAXCHANGER®

If prime application considerations include a variety of connection locations, space, and single-material design, these unique, all-welded plate exchangers are extremely versatile. They can be used in many duties where shell and tube units typically cool mechanical and electrical equipment—liquid-to-liquid, steam-to-liquid, gas-to-liquid, gas-to-gas and refrigerant applications (including ammonia).

Standard models are designed for 500°F maximum operating temperature and 150 psig standard working pressure, but custom models up to 1000°F and 975 psig are available.



## PLATECOIL®

These versatile, highly efficient prime surface heat exchangers replace costly, unwieldy pipecoil, steam sparging or expensive resistance heating elements. High internal flow velocities of these exchangers generate effective heat transfer rates.

Tranter's exclusive Multi-Zone configuration—designed to uniformly deliver steam to all levels of the unit through zoned headers—and two Serpentine configurations are available in over 300 standard sizes, or can be custom designed. Single- and double-embossed styles may be flat, bent or rolled as immersion heaters, banked for tanks, used in mixers, cryogenic shrouds, jacketed vessels, clamp-on panels, and a wide variety of other configurations.







Notes:

Notes:



Tranter PHE, Inc. ▲ Texas Division ▲ P.O. Box 2289 ▲ Wichita Falls, Texas 76307  
(940) 723-7125 ▲ Fax (940) 723-5131  
<http://www.tranterphe.com>

Tranter, Inc. also manufactures PLATECOIL® prime surface, MAXCHANGER® compact all-welded plate,  
ULTRAMAX™ all-welded plate, WIDEMAX™ all-welded wide-gap plate and SUPERMAX™ plate and shell.