

1993 Westinghouse World Series Electric Motor- 1000 HP

Mfg: Westinghouse

Model:

Stock No: DTTC2066B

Serial No: 5806BA-02

1993 Westinghouse World Series Electric Motor- 1000 HP. S/N: 5806BA-02. Motor specifications: 3580 rpm, 4160 V, 122 FLA, 60 Hz, 3 phase. Frame: 4009. Enclosure: ODP. Insulation class: F. Weight: 4820 lbs. Overall dimensions: 5 ft. 6 in. L x 5 ft. 5-1/2 in. W x 4 in. H.



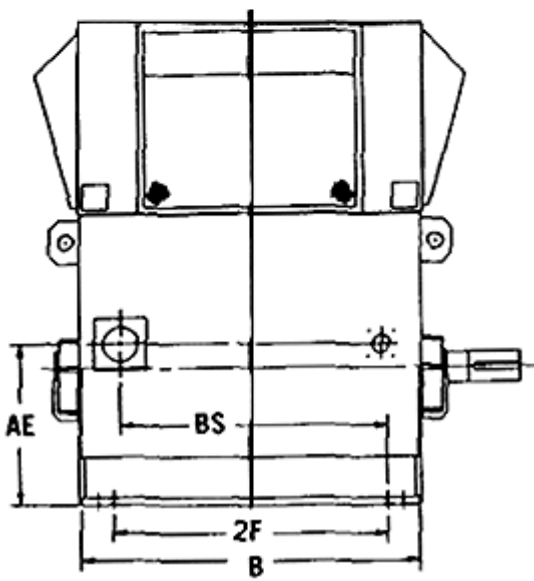
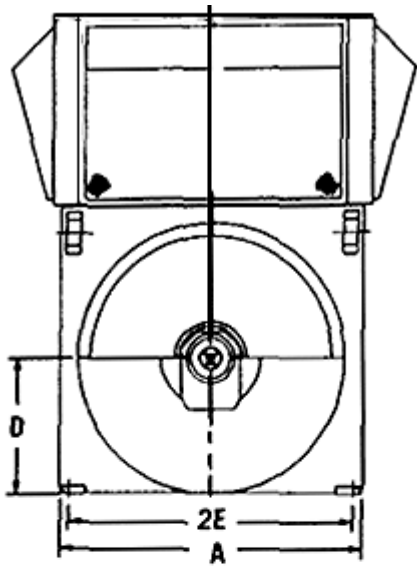

FRAME	# POLES	EST.WT.	D	2E	A	2F	B	D	2E	A	2F	B
		LBS.			IN.					MM.		
3505	4P UP	3200	13.98	28.0	31.3	22.0	32.9	355	710	795	560	836
3506	2P	3500	13.98	28.0	31.3	24.8	35.6	355	710	795	630	904
3507	4P UP	3800	13.98	28.0	31.3	28.0	38.8	355	710	795	710	986
3508	2P	4000	13.98	28.0	31.3	31.5	42.3	355	710	795	800	1074
3509	4P UP	4300	13.98	28.0	31.3	35.4	46.3	355	710	795	900	1176
3510	2P	4700	13.98	28.0	31.3	39.4	50.2	355	710	795	1000	1275
4008	4P UP	4800	15.75	31.5	35.2	31.5	42.3	400	800	900	800	1074
4009	2P	5100	15.75	31.5	35.2	35.4	46.5	400	800	900	900	1181