



BY JOHNSON CONTROLS

Submittal Data Form:

2010-10-28

Sold To: JOHNSON CONTROLS/FRICK  
100 CV AVENUE  
P.O. BOX 997  
Waynesboro, PA 17268-1496  
USA

All information is Per Unit

Quantity: 4 Model XLP2-1224-1144 Evaporative Condensing Unit (Tag Units as "EC-1, EC-2, EC-3 & EC-4")

Certified Capacity: 11312.00 MBH based on 95.00°F condensing temp. with an entering air wet bulb of 76.90°F. Refrigerant: R-717.

Fan Motor(s): Four (4) 10 HP fan motor(s). Totally Enclosed, Fan Cooled (TEFC),  
1 Speed/1 Winding - Premium Efficiency (Inverter Duty), suitable for 460 volt, 3 phase,  
60 hertz electrical service. Drives are based on 0 inches ESP.

NOTE: Inverter Duty fan motors, furnished in accordance with NEMA Standard Mg.1 -- Part 31, are required for applications using variable frequency drives for fan motor control

Pump(s): Two (2) 5 HP pump motor: 1 Speed/1 Winding - Standard Efficiency, suitable for 460 volt, 3 phase, 60 hertz.

Submittal Information		Equipment Summary
Submittal Drawings/Diagrams	Unit Print-Right Hand	Forced Draft, Counterflow Evaporative Condenser Quality Assurance - ISO 9001 Certified Steel Panels and Structural Members are Constructed of Galvanized Steel Galvanized Steel, Full Circuit Coil Polyvinyl Chloride (PVC) Drift Eliminators Standard Unit Anchorage Independent Fan Drive Integral Pump(s) with Standard Make-Up, Drain and Overflow Connections Electric Water Level Control Package with High & Low Level Alarm & Solenoid Valve Electric Immersion Heaters Sized to Maintain +40°F water at a -20°F Ambient with Electrical Requirements Matching Fan Motor(s) Heater Control Panel with Contactor and Disconnect An L Shaped Access Platform, Spanning Face C and Face D The Aluminum Ladder and Galvanized Steel Safety Cage is Located on Face D at Face D-A Corner Second Aluminum Ladder and Galvanized Steel Safety Cage is Located on Face C at Face C-B Corner Galvanized Steel Supports Factory Wiring of Electrical Components to Terminal Box(es)
UP-U110077001-QTY 4-R1	Unit Support	
SS-U110077001-QTY 4-R1	Basin Accessories	
BA-U110077001-QTY 4-R1	Basin Heater Wiring	
HW-U110077001-QTY 4-R2	EWLC Wiring	
JCI-13192AX	Terminal Box Wiring	
TB-U117001AX	External Access	
EA-U110077001-QTY 4-R2		
Mechanical Specifications		
Seismic Compliance Certificate		
Sound Data		
		See Mechanical Specification & Drawings for more detail.

THANK YOU FOR YOUR BUSINESS!

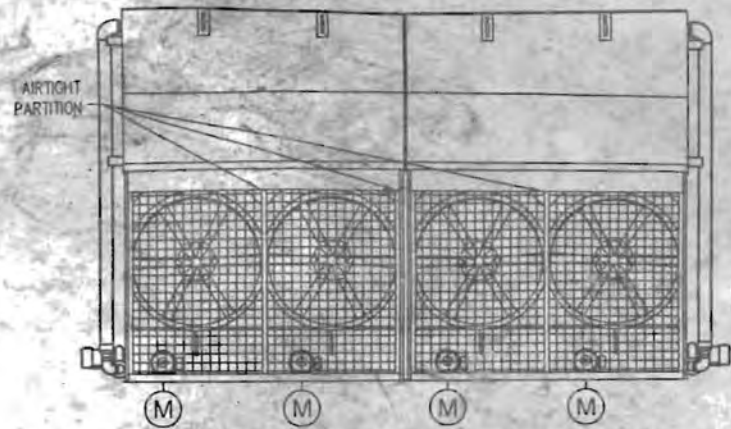
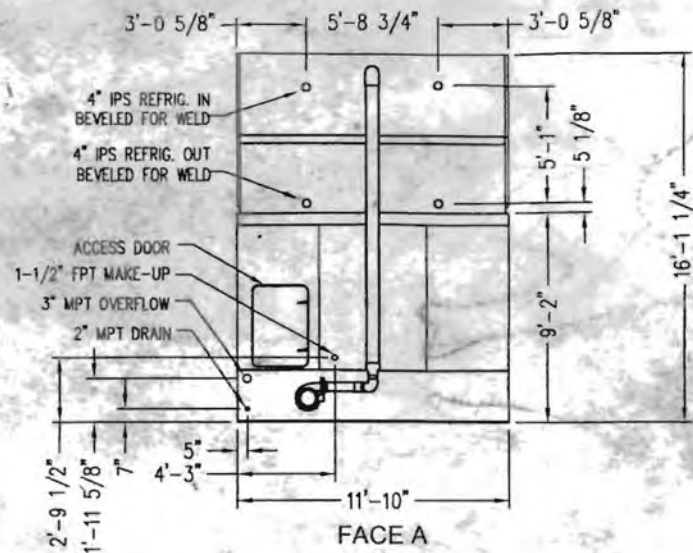

FACE D

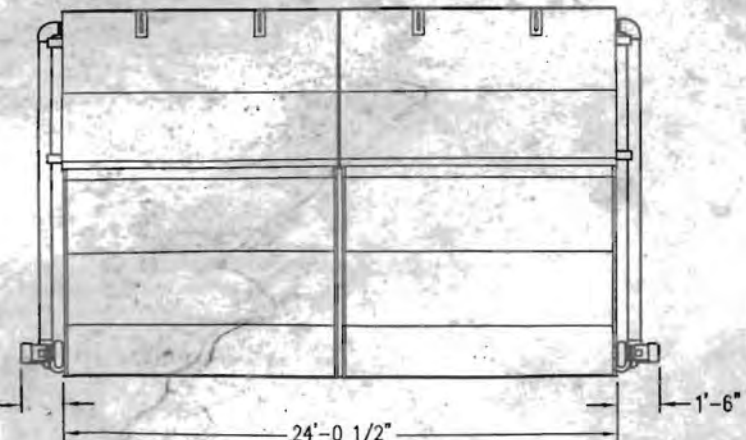

FACE C

Tag Units as \*EC-1, EC-2, EC-3 & EC-4\*

Notes

- 1) Drawings are not to scale. All dimensions are in feet and inches. Weights are in pounds and include options and accessories.
- 2) Unless otherwise indicated, connections 3" and smaller are MPT. Connections 4" and larger are grooved to suit a mechanical coupling and beveled for welding.
- 3) Dimensions showing location of coil connections are approximate and should not be used for prefabrication of connecting piping.
- 4) For weight loadings and support requirements, refer to the suggested steel support drawing.
- 5) The area above the discharge must be unobstructed.
- 6) Piping must not be supported by the unit inlet or outlet connections.
- 7) M = Motor location, M1 = Large Motor Location, M2 = Small Motor Location

Right Hand Unit

Model Number	Shipping Weight	Operating Weight	Heaviest Section
XLP2-1224-1144	42590	58840	17340

ORDER NO: U110077001-QTY (4)

DATE: 10/28/2010

**Frick**  
BY JOHNSON CONTROLS

Unit Print

24' Long Side Blow

DRAWING NUMBER:

UP-U110077001-QTY 4-R1

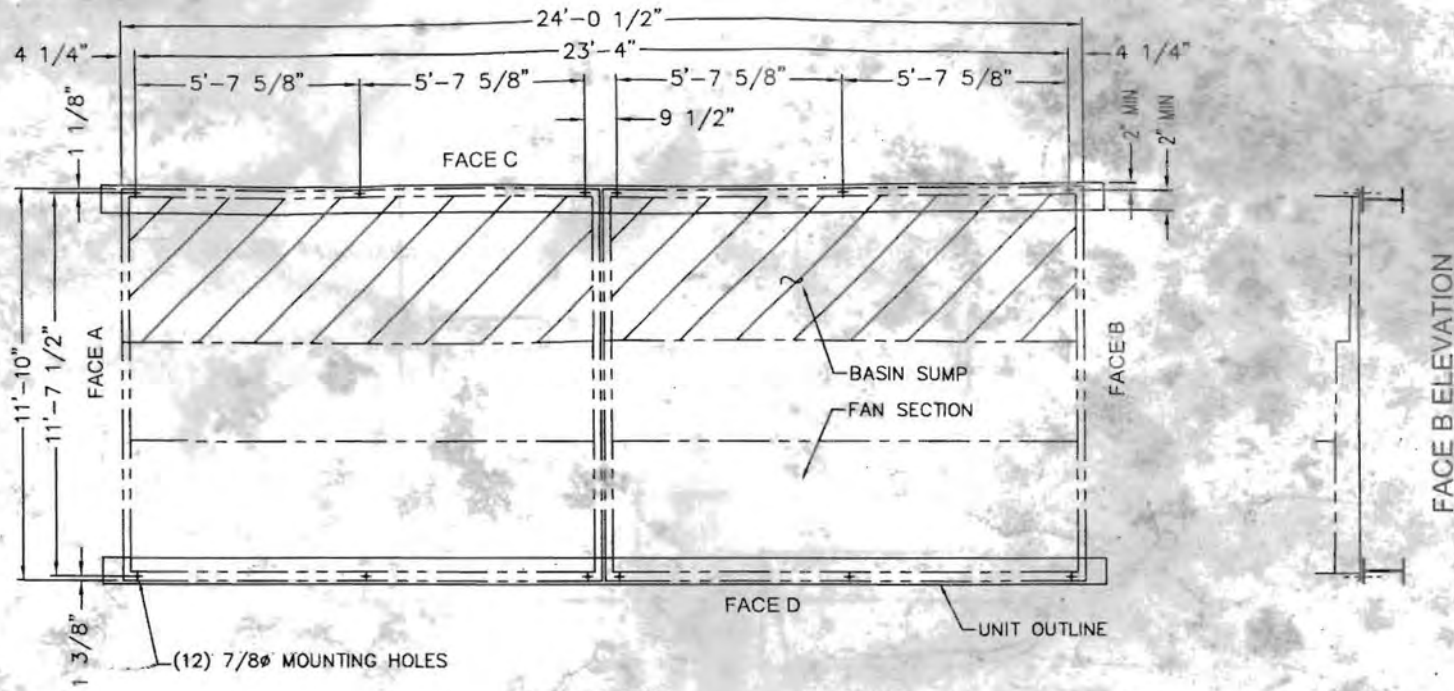

PLAN VIEW

- Notes
- 1) Drawings are not to scale. All dimensions are in feet and inches. Weights are in pounds and include options and accessories.
  - 2) Operating weight and weight loading are for units with water level in basin at overflow.
  - 3) Unit support beams and anchor bolts to be designed and furnished by others.
  - 4) Support beams must be flush and level at top.
  - 5) Each beam should be designed, as a minimum, for 65% of the total unit operating weight applied as a uniformly distributed load.

Model Number	Shipping Weight	Operating Weight
XLP2-1224-1144	42590	58840

Tog Units as "EC-1, EC-2, EC-3 & EC-4"

ORDER NO: <input type="text"/>	<b>Frick</b> BY JOHNSON CONTROLS	Unit Support 24' Long Side Blow
DATE: 10/28/2010		DRAWING NUMBER: <input type="text"/>

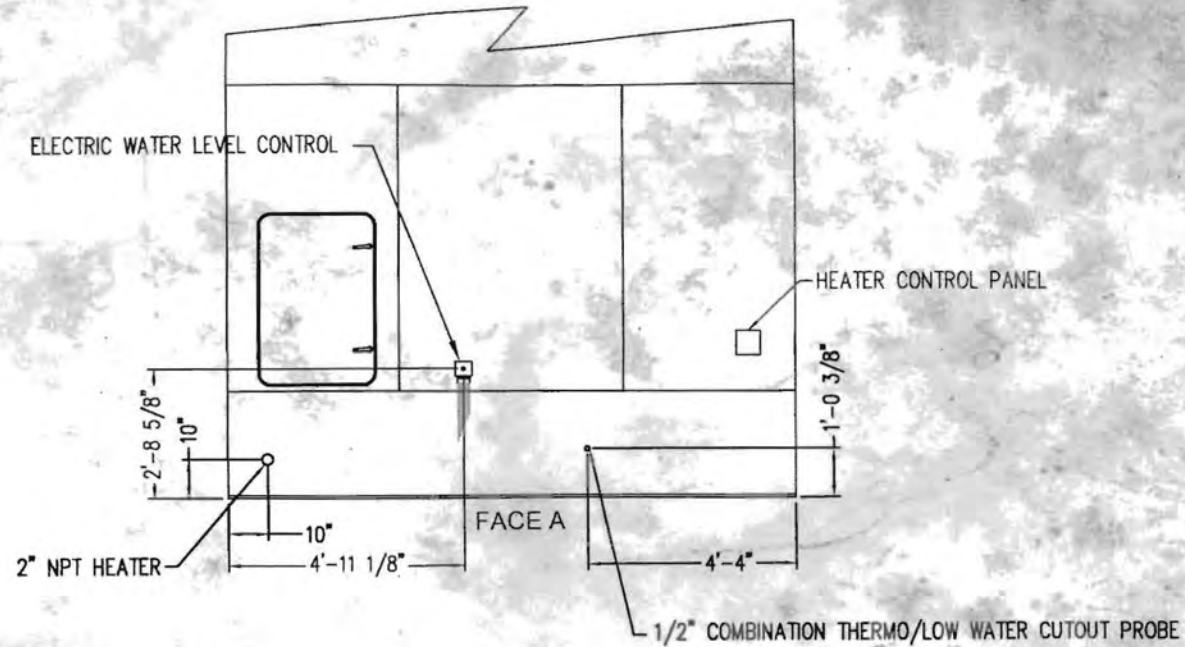

• Tag Units as "EC-1, EC-2, EC-3 & EC-4"

Right Hand Unit

Model Number
XLP2-1224-1144

ELECTRIC IMMERSION HEATERS

AMBIENT TEMPERATURE: -20F  
 HEATER QTY: 2 (1 EACH END)  
 POWER (EACH): 15KW  
 VOLTAGE: 460V  
 PHASE: 3  
 FREQUENCY: 60Hz

ORDER NO:

DATE: 10/28/2010



Basin Accessories

Side Blow

DRAWING NUMBER:

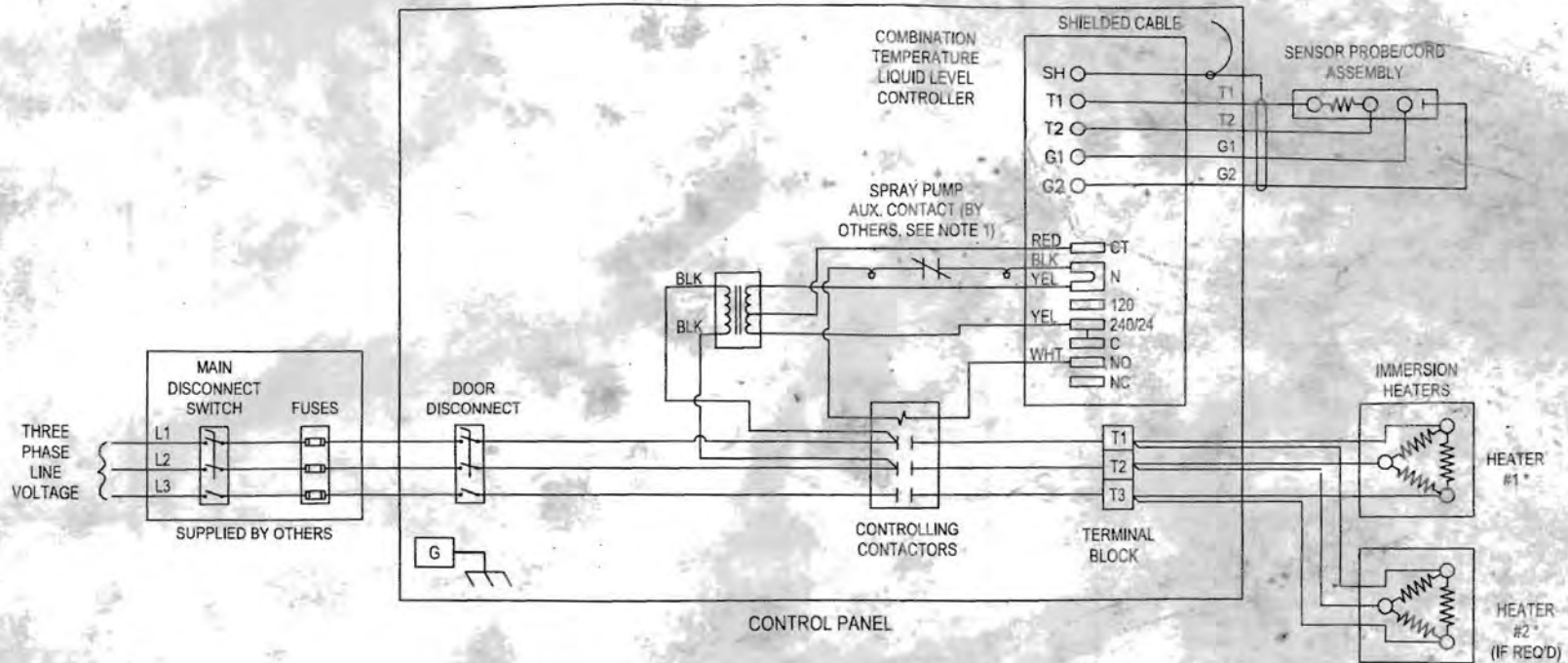

**NOTES:**

1. INTERLOCK IMMERSION HEATERS WITH SPRAY WATER CIRCULATING PUMP TO DE-ENERGIZE HEATERS WHEN SPRAY PLUMP IS RUNNING.
2. CONTROL THERMOSTAT IS TO BE AT 40°F. DO NOT SET THERMOSTAT LOWER THAN 40°F.
3. FUSE PROTECTION AND POWER SUPPLY WIRING ARE TO BE SIZED TO MATCH HEATER REQUIREMENTS. WIRING MUST COMPLY WITH APPLICABLE CODES AND ORDINANCES.
4. THIS DRAWING IS SUPERSEDED BY ANY DRAWING SUPPLIED WITH PANEL BY MANUFACTURER.

\* Refer to heater package drawings for heater power values.

SYMBOLS	DESCRIPTION
----	BROKEN LINES INDICATE WIRING AND COMPONENTS SUPPLIED BY OTHERS.
—	SOLID LINES INDICATE WIRING AND COMPONENTS SUPPLIED BY BAC.

Tag Units as "EC-1, EC-2, EC-3 & EC-4"

Data Version 1.07  
DWG Version 1.00

ORDER NO:

DATE: 10/28/2010



Electric Immersion Heater Wiring  
Single Contactor with Terminal Block

DRAWING NUMBER:

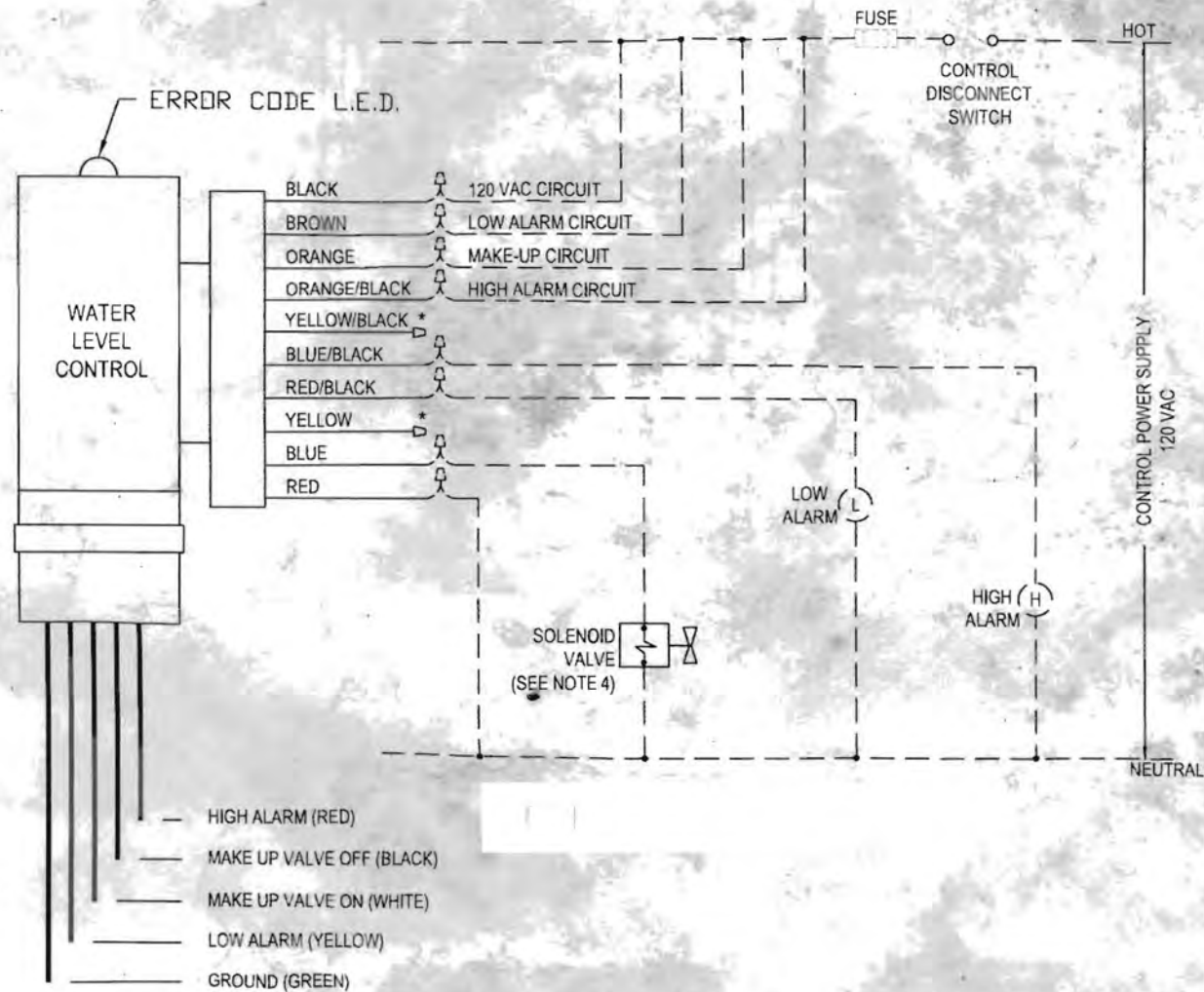

**NOTES:**

1. WIRING AND COMPONENTS INDICATED BY DASHED LINES ARE TO BE SUPPLIED BY FIRMS OTHER THAN "BAC". ALL WIRING MUST COMPLY WITH APPLICABLE CODES AND ORDINANCES.
2. THE WATER LEVEL CONTROL BOARD IS WIRED IN THE INVERSE MODE SO THAT THE SOLENOID MAKE-UP VALVE WILL CLOSE IF THERE IS A LOSS OF POWER TO THE CONTROL BOARD. WHEN THE WATER LEVEL RISES TO THE BOTTOM OF THE MAKE-UP VALVE OFF PROBE AND MAINTAINS CONTACT FOR AT LEAST 6 SECONDS, THE CONTROL DE-ENERGIZES THE VALVE. THE VALVE REMAINS DE-ENERGIZED UNTIL THE WATER LEVEL RECEDES BELOW THE BOTTOM OF THE MAKE-UP VALVE ON PROBE AND REMAINS AT THAT LEVEL FOR AT LEAST 6 SECONDS. THE CONTROL THEN ENERGIZES THE VALVE.
3. EACH WATER LEVEL CONTROL FUNCTION UTILIZE CONTACTS THAT ARE RATED AT 3A RESISTIVE. THE WATER LEVEL CONTROL BOARD REQUIRES 4.4 VA. SUGGESTED FUSE SIZE IS LESS THAN 1A.
4. THE SOLENOID ACTUATED MAKE-UP VALVE IS RATED AT 6.1 WATTS, 16 VA HOLDING, 30 VA INRUSH.
5. THE NORMALLY CLOSED SOLENOID VALVE HAS A SLOW CLOSING FEATURE WHICH MINIMIZES WATER HAMMER AND IS DESIGNED TO OPERATE AT MAKE-UP WATER LINE PRESSURES OF 10 TO 125 PSIG. TO FURTHER MINIMIZE THE POTENTIAL FOR WATER HAMMER, MAKE-UP WATER LINE PRESSURES AT THE HIGHER END OF THE RANGE SHOULD BE AVOIDED, AND MAKE-UP PIPING SHOULD BE WELL SUPPORTED.
6. A STRAINER IS REQUIRED BEFORE THE SOLENOID MAKE-UP VALVE.

**L.E.D. ERROR CODES:**

1. STEADY ON SECOND FLASHING:  
DIRTY PROBES - OVERRIDES ALL OTHER ERROR CODES
2. TWO FLASHES AND OFF FOR 5 SECONDS:  
MAKE-UP ON FOR MORE THAN 1 HOUR
3. THREE FLASHES AND OFF FOR 5 SECONDS:  
SHORTED OR HIGH CONDUCTIVITY WATER
4. FOUR FLASHES AND OFF FOR 5 SECONDS:  
SHORT FILL CYCLE - WHITE PROBE IS DIRTY OR NONFUNCTIONAL
5. L.E.D. ON STEADY:  
NORMAL OPERATION

ORDER NO:

**Frick**  
BY JOHNSON CONTROLS

Electronic Water Level Control Wiring

DRAWING NUMBER:

Notes  
 1) Right hand unit wiring shown, left hand unit mirror image.

WIRING SUPPLIED BY BAC  
 TO FACTORY INSTALLED COMPONENTS

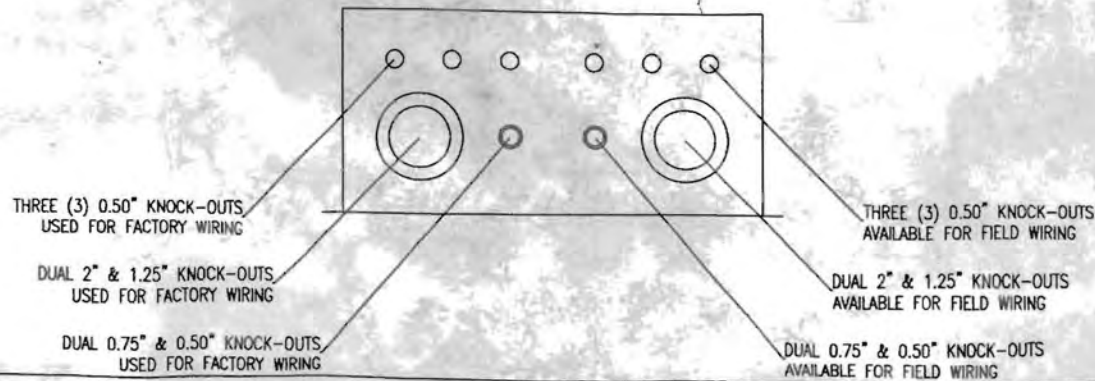
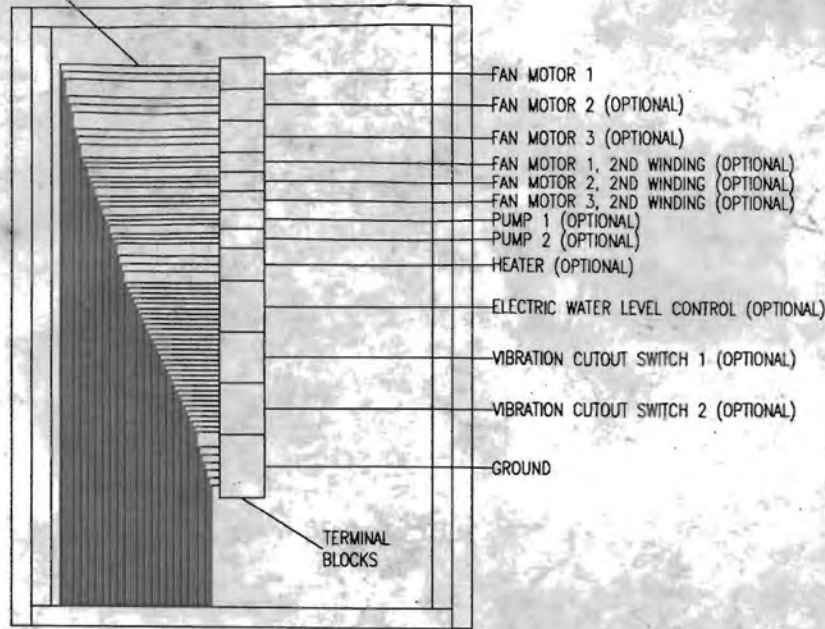

Tag Units as "EC-1, EC-2, EC-3 & EC-4"

Data Version 1.07  
 DWG Version 1.00

ORDER#

DATE: 10/28/2010

**Frick**  
 BY JOHNSON CONTROLS

Terminal Box Wiring

DRAWING NUMBER:

Notes

- 1) Drawings are not to scale.
- 2) Platforms and access ladder ship pre-assembled and separate for field installation. A crane will be required to set the platform modules.
- 3) Maximum platform module weight is 200 lbs.
- 4) Platforms may be installed prior to setting the casing onto lower section of unit, however some platform supports extend below the bottom of the casing requiring the casing to be elevated. Maximum elevation required is 30".
- 5) Field piping must clear access ladder and platform structure and be supported independently of unit.
- 6) Refer to OSHA and local occupational safety regulations to determine if safety cages are required.

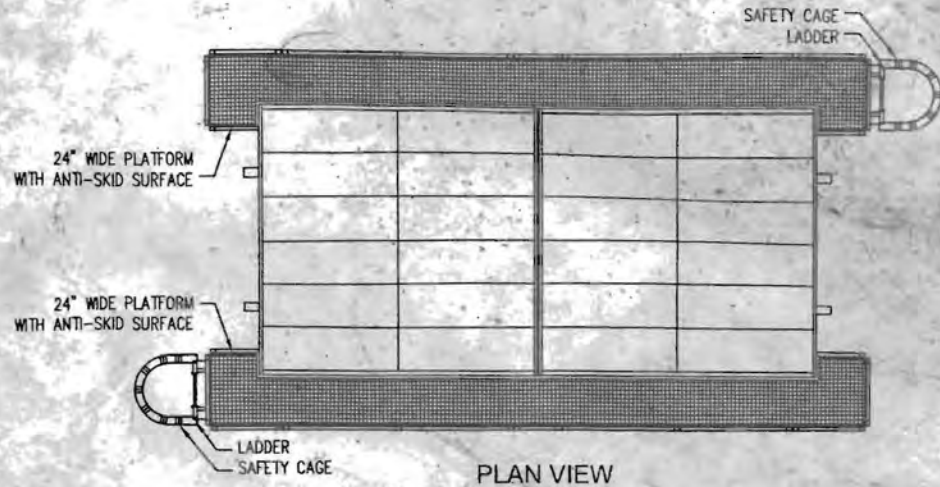

PLAN VIEW

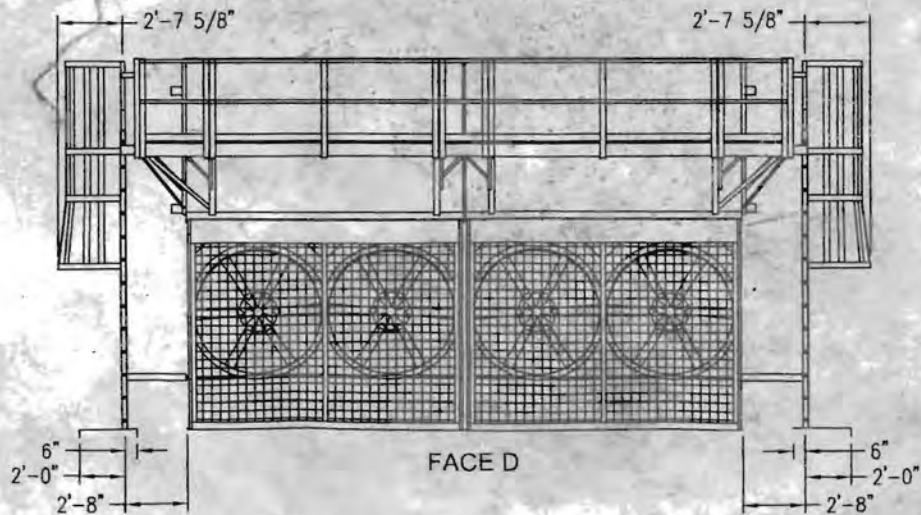
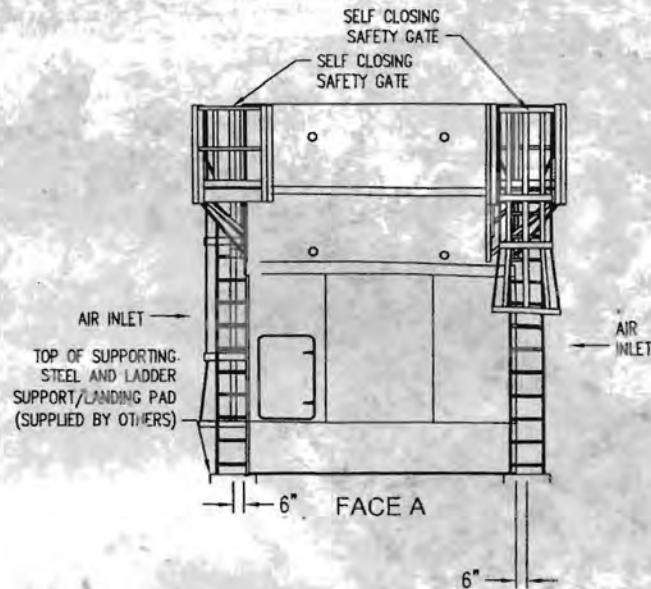

Tag Units = EC-1, EC-2, EC-3 & EC-4

ORDER NO: U1100

DATE: 10/28/2010

**Frick**  
BY JOHNSON CONTROLS

XLP2 Access Platform  
24' Long Side Blow

DRAWING NUMBER: