



Form S70-200 OM (DEC 1999)

OPERATION - MAINTENANCE

File: SERVICE MANUAL - Section 70
Replaces: S70-200 OM/MAR 99
Dist: 3, 3a, 3b, 3c

RWBII *Plus*

MICROPROCESSOR CONTROL

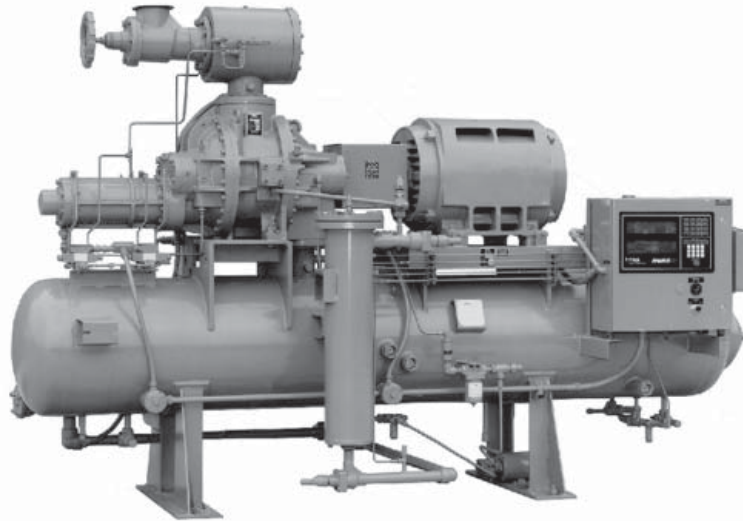

THIS MANUAL CONTAINS OPERATION AND MAINTENANCE INSTRUCTIONS. READ THOROUGHLY BEFORE BEGINNING INSTALLATION. FAILURE TO FOLLOW THESE INSTRUCTIONS COULD RESULT IN DAMAGE OR IMPROPER OPERATION OF THE UNIT.

Please check www.frickcold.com for the latest version of this publication.

Contents

MICROPROCESSOR CONTROL PANEL	3
KEYS AND KEY FUNCTIONS	4
TO CHANGE THE ADJUSTABLE SETPOINTS:	6
HOW TO DETERMINE ADJUSTABLE SETPOINTS:	7
TEMPERATURE-PRESSURE CONTROL PROGRAM (OPTION)	10
LEAD-LAG OPTION	12
COMMUNICATIONS TROUBLESHOOTING	13
HOW THE MICROPROCESSOR WORKS - SUMMARY -	13
MULTIPLE COMPRESSOR SEQUENCING	14
SUGGESTED PROGRAMMABLE CONTROLLER PROGRAM TO DECODE MICROPROCESSOR OUTPUT DATA CODES	14
MICROPROCESSOR OUTPUT DATA CODE	15
MICROPROCESSOR TELECOMMUNICATIONS	16
COMMUNICATIONS PROTOCOL SPECIFICATIONS:	16
TRUBLESHOOTING THE RWB II PLUS MICROPROCESSOR	20
GENERAL INFORMATION	20
TRUBLESHOOTING FRICK SBC MICROPROCESSOR SYSTEM	20
TESTING MICRO-PANEL ALARMS/CUTOUPS	23
EPROM MEMORY I/C CHIP REPLACEMENT	25
SBC BOARD REPLACEMENT	25
MICROPROCESSOR DISPLAY REPLACEMENT	25
OUTPUT FUSE REPLACEMENT	25
SBC WIRING DIAGRAM	26
POINT-TO-POINT FIELD WIRING DIAGRAM	26
MICRO COMPONENT PLACEMENT DIAGRAM	27
RWB II PLUS TELECOMMUNICATIONS	27
MICROPANEL ASSEMBLY WIRING DIAGRAMS	28

Operation

MICROPROCESSOR CONTROL PANEL

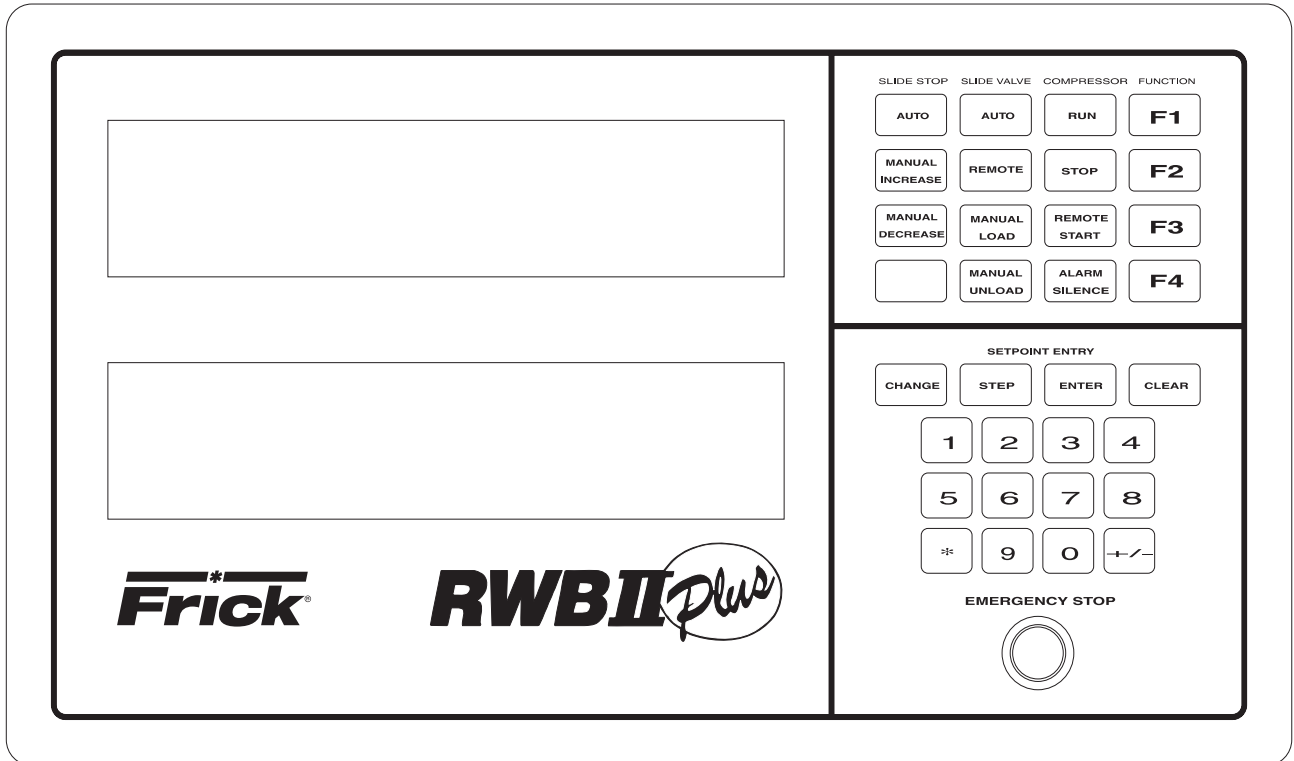

WARNING

The following must be read in addition to the Operation and Start-up instructions in S70-200 IOM before attempting to start or operate the unit.

The RWB II PLUS compressor is controlled by a state-of-the-art microprocessor control system. The microprocessor continuously monitors the compressor unit's condition and operation. The microprocessor also directs instructions to the various compressor unit subsystems.

The microprocessor has a membrane switch keyboard. Pressing the keyboard in the area outlined as a key will cause that function to be recognized by the microprocessor. The keyboard has 32 membrane type keys.

In addition to the keyboard, there is an emergency stop button. Pushing the emergency stop will bypass the computer and remove all power from the outputs.

This will shut down the compressor motor and all high voltage to the compressor auxiliary systems such as the oil pump and liquid injection solenoid. **THE EMERGENCY STOP BUTTON IS FOR EMERGENCY SHUTDOWN SITUATIONS ONLY and MUST NOT BE USED TO ROUTINELY SHUT OFF THE COMPRESSOR.**

The microprocessor continuously monitors the state of the battery which maintains setpoints and various other data. If the battery voltage is low, the message "LOW BATTERY" will flash in the lower right hand corner of the bottom display (see S70-200 IOM for description of battery backup).

The microprocessor hardware contains an output watchdog circuit. If the microprocessor should fail, this circuit will disable (turn off) all outputs.

KEYS AND KEY FUNCTIONS

NOTE: The microprocessor will automatically return to the main operating display after 60 seconds of keyboard nonactivity.

The [CHANGE] key rotates the dual display screen through six display modes. The [CHANGE] key is also used to change the status of various setpoints.

The [STEP] key steps or moves a set of flashing brackets through the variable setpoints on the Adjustable setpoints display, the Auto-cycle display, the Security display and the Setback display. The setpoint enclosed within the flashing brackets may be changed or updated. The [STEP] key is also used when the annunciator display is selected to step through the annunciator's four information displays.

NOTE: The [*] key is used to step or move the flashing brackets, described above, backwards.

The [ENTER] key is used to enter new setpoint limits.

The [CLEAR] key will reset an alarm or cutout indication on the annunciator screen and will clear the microprocessor to allow continued operation or restarting if all conditions have returned to normal and no other control lockouts are in force.

The [NUMERIC KEYPAD] is used to introduce new setpoint limits.

The [+/-] key is used to toggle between pounds per square inch gauge (g) and inches of mercury (hg).

The [RUN], [STOP], and [REMOTE START] keys control the starting and stopping of the compressor unit.

The [ALARM SILENCE] key will de-energize the alarm horn output.

The [AUTO], [REMOTE], and [MANUAL] keys control the operation of the compressor slide valve and moveable slide stop.

The [F1] function key will return the operator to the main operating display. This function may be invoked at any time, even during setpoint entry.

The [F2] function key will call up the Security display. **NOTE: Press the [F2] key, as prompted by the display, to return to the previously selected display.**

The [F3] function key will call up the Setback display. **NOTE: To exit the Setback display, press the [F1] key as prompted by the display.**

The [F4] function key will call up the Auto Cycle display. **NOTE: To exit the Auto Cycle display, press the [F1] key as prompted by the display.**

The [DISPLAY BACKLIGHT] key will toggle the dual LCD display backlights on and off. A preset delay will shut off the backlight after ten minutes elapsed time.

The microprocessor has two liquid crystal displays in an 8 line by 40 character format, for a total of 320 characters. There are 9 different display modes. When power is first applied to the

control panel, the unit will be in the Operating display mode. To change to a different display mode, press the [CHANGE] key. The display modes in their order of rotation are:

- | |
|----------------------------------------------------------------------------------------------------------------------------------------------------------------------------------------------------------------------------------------------------------------------------------------------------------|
| <ol style="list-style-type: none"> 1. Operating display 2. Adjustable Setpoints display 3. Adjustable Setpoints display #2 4. Fixed Setpoints display 5. Annunciator display (4 pages) 6. Shutdown Record display 7. Freeze display |
|----------------------------------------------------------------------------------------------------------------------------------------------------------------------------------------------------------------------------------------------------------------------------------------------------------|

- | |
|--------------------------------------------------------------------------------------------------------------|
| <p>[F1] Operating display
[F2] Security display
[F3] Setback display
[F4] Auto Cycle display</p> |
|--------------------------------------------------------------------------------------------------------------|

NOTE: On initial powering of the microprocessor, and any time power has been removed from the microprocessor, only the Operating, Setpoints, Annunciator, and Shutdown displays will display information. The freeze display will appear as a dark screen. The Freeze display will only be present after a compressor unit cutout and power has not been interrupted to the microprocessor. The cutout must be on a safety setpoint. When power is lost to the micro, it will not show the freeze display.

OPERATING DISPLAY *

OPERATING DISPLAY: Thu 10-01-87 15:33:36					
Suction	Disch	Oil	Filter	Compressor	
20.0 g	180 g	170 g	01PSID	MAN Mode	
+015 F	140 F	135 F		RUNNING	

V Ratio	S V Pos	Pump	%FLA	Sep	132 F
4.6	090%	OFF	080%	HTR	off
Auto D	Auto L	FORCED	UNLD	ALARM	
C.C.=20.0 g				LOW-BATTERY	

*Display for illustrative purposes only.

The Operating display is continuously updated and provides a variety of information in regard to the current status of the compressor's condition and performance.

The information furnished by the Operating display is as follows:

The **DAY**, **DATE**, and **TIME** are displayed at the top right of the display.

NOTE: To set day, date, and time; see TO CHANGE THE ADJUSTABLE SETPOINTS.

SUCTION - Suction Pressure and Temperature are measured at the compressor inlet and are, respectively, displayed in pounds per square inch gauge (g) or inches of mercury (hg) and degrees Fahrenheit.

DISCH - Discharge Pressure and Temperature are measured at the compressor outlet and are, respectively, displayed in pounds per square inch gauge (g) and degrees Fahrenheit.

OIL - Oil Pressure and Temperature are measured prior to entering the compressor and are, respectively, displayed in pounds per square inch gauge (g) and degrees Fahrenheit.

FILTER - Pressure drop across the oil filter. On the model 676 only, the bearing oil filter pressure drop is displayed. The main oil injection feed filter pressure drop is shown on a unit mounted gauge.

COMPRESSOR - Compressor displays the status of the compressor unit. The mode of operation will be indicated as either manual (MAN MODE) when the [RUN] key has been pressed, automatic (AUTO MODE) when Auto Cycle has been activated, remote (RMT MODE) when the [REMOTE] key has been pressed, or off (OFF MODE).

V RATIO - Volume Ratio is the ratio selected by the microprocessor to provide the highest efficiency at any given suction and discharge pressure condition. Immediately below this, an information space has been provided to indicate whether V ratio is in the automatic (AUTO) or the manual (MAN) mode. The microprocessor will control this function only in the automatic mode. To the right of the mode indicator, two other messages may appear:

- I - Indicates V Ratio increase.
- D - Indicates V Ratio decrease.

SV POS - Slide valve position is displayed as a percentage. This percentage reflects the mechanical position of the slide valve and does not reflect the percentage of full load operation. Immediately below this information, space has been provided to indicate whether SV Pos is in the automatic (AUTO), manual (MAN), or remote (RMT) mode. The microprocessor will control this function in the automatic mode. To the right of the mode indicator, two other messages may appear:

- L - Indicates Slide Valve loading.
- U - Indicates Slide Valve unloading.

PUMP - Pump displays the current status of the oil pump. The display will read ON or OFF whenever the HAND-OFF-AUTO switch is selected to AUTO and the compressor is running.

% FLA - Percent Full Load Amps displays the percentage of the drive motor full load amperage rating that the motor is currently using.

SEP - Separator displays the oil separator temperature in degrees Fahrenheit.

HTR - Heater displays the condition of the oil separator heater(s), indicating ON or OFF.

ALARM/CUTOUT - An Alarm or Cutout message indicates an Alarm or Cutout setpoint has been reached, or exceeded. Rotate the display mode to the Annunciator display for details. In the event of a cutout, rotate to the Freeze display for further details.

FORCED UNLD - A Forced Unload message indicates that the percentage of motor full load amps has exceeded the maximum limit and the microprocessor is unloading the compressor until the percentage FLA falls back to normal limits.

RECYCLE DELAY - A Recycle Delay message indicates that the compressor has started and has shut down within the time delay set point period. The Recycle Delay will prevent the compressor from starting until the delay time expires and is intended to prevent damage to the compressor motor from successive restarts. During Recycle Delay, the microprocessor will alternatively flash "RECYCLE DELAY" and the remaining delay time in minutes.

*Display for illustrative purposes only.

NOTE: Consult Motor Manufacturer for the recommended duration of the Recycle Delay.



If the [RUN] key is pushed while the unit is in Recycle Delay, the compressor will start at the end of the delay period.

C.C. - Capacity Control, located at the bottom left of the display, indicates the current capacity control suction pressure setpoint in pounds per square inch gauge (g) or inches of mercury (hg).

ADJUSTABLE SETPOINTS DISPLAY *

ADJUSTABLE SETPOINTS: ID=[33] [10-01-87]	
Cap. Control---	[20.0 g] Thu [15:33:36]
Lo Suct Cutout--	[12.0 g] Baud----[2400]
Lo Suct Alarm--	[16.0 g]
Hi Disch Cutout--	[225 g] Aux1[Alarm][NO]
Hi Disch Alarm--	[215 g] Aux2[Shutd][NC]
M.L.C. Stop Load--	[095%] CT Factor-[078]
M.L.C. Force Unld-	[100%] Recy.Delay-[30]

The Adjustable Setpoints display lists the adjustable setpoints which define the limits of the compressor package operation. When these limits are reached, or exceeded, an alarm or compressor shutdown will occur. The information furnished by the Adjustable Setpoints display is as follows:

CAP CONTROL - The Capacity Control setpoint, reported in pounds per square inch gauge (g) or inches of mercury (hg), controls the loading and unloading of the compressor when **SV POS** is in the automatic (AUTO) mode.

LO SUCT CUTOUT - The Low Suction Pressure Cutout, reported in pounds per square inch gauge (g) or inches of mercury (hg), will shut down the compressor if the suction pressure drops to this limit, or lower, for 120 seconds or longer.

LO SUCT ALARM - The Low Suction Pressure Alarm, reported in pounds per square inch gauge (g) or inches of mercury (hg), will trigger a prealarm if the suction pressure drops to this limit, or lower.

HI DISCH CUTOUT - The High Discharge Pressure Cutout, reported in pounds per square inch gauge (g), will shut down the compressor if the discharge pressure equals, or exceeds, this setpoint.

HI DISCH ALARM - The High Discharge Pressure Alarm, reported in pounds per square inch gauge (g) will trigger a pre-alarm if the discharge pressure equals, or exceeds, this setpoint.

M.L.C. STOP LOAD - The Motor Load Control Stop Load, reported as a percentage of the motor full load amps (FLA), will prevent the compressor slide valve from loading when the setpoint is equaled, or exceeded. **NOTE: Consult motor nameplate for recommended setpoint.**

M.L.C. FORCE UNLD - The motor Load Control Force Unload, reported as a percentage of the motor full load amps (FLA), will force the compressor to unload until the motor full load amps (FLA) fall within 1% of the setpoint, or lower.

NOTE: Consult motor nameplate for recommended setpoint.

ID - The ID number is a programmable identification code used in telecommunications to access a specific compressor.

DATE - The Date displays the current date in the following format: Month - Day - Year.

DAY - Day will display the current day of the week.

TIME - The Time displays the current time in the following format: Hours - Minutes - Seconds. The time is in 24:00:00 hour clock format.

BAUD - Shows the baud rate of the RS422 communication ports 1 and 2. Both ports are configured as follows: word = 8 bit, parity = none or even, stop = 1 bit. The communications ports are programmable from 300 to 19200 baud.

AUX 1 and AUX 2 - May be configured for either an alarm or shutdown and with either a normally closed (**NC**) or normally open (**NO**) contact.

CT FACTOR - The Current Transformer Factor records the proper current transformer factor to match the compressor motor FLA rating to the current transformer primary rating. The CTF factor is programmable and its correct value is determined by the following formula:

$$CTF = \frac{1024 \times FLA \text{ (Full Load Amps)}}{10 \times CT \text{ (Current Transformer Primary Amps)}}$$

EXAMPLE: FLA = 230 Amps
CT = 300 (300:5)

$$CTF = \frac{1024 \times 230}{10 \times 300} = 78 \text{ (Round to whole number)}$$

RECY. DELAY - The Recycle Delay displays the current recycle delay setpoint in minutes. **NOTE: Consult motor manufacturer for recommended setpoint.**

ADJUSTABLE SETPOINTS PAGE 2 *

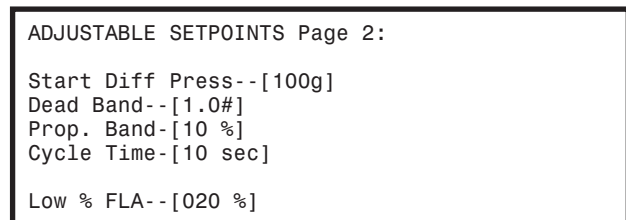

Dead Band - This is a + (plus) or - (minus) value above or below the setpoint at which the compressor will neither load nor unload. A dead band of 1 is the default value. It is adjustable between .5 lbs. to 5 lbs. in increments of .5. The "Step" key is used to select this setpoint; then press the "Change" key to toggle through the selections.

Proportional Band - This setpoint is used to determine the amount of time the load/unload solenoid is energized, according to how far from the setpoint the actual control pressure is. The smaller the number, the longer a load/unload signal will be sent. 10% is the default value. Selections are 2, 5, 10, 15, 20, or 25%. The "Step" key is used to select this setpoint; then press the "Change" key to toggle through the selections.

*Display for illustrative purposes only.

Cycle Time - Cycle time is the amount of time between the beginning of each load/unload response. Ten seconds is the default value. "Cycle Time" is adjustable between 5 and 30 seconds in 5 second intervals. The "Step" key is used to select a setpoint; then press the "Change" key to toggle through the selections.

Low % FLA - This setpoint is used to determine if the coupling has broken. 20% is the default value. It is adjustable from 0 to 100% FLA. Use the "Step" key to select a setpoint; then enter the desired setpoint and press the "Enter" key.

TO CHANGE THE ADJUSTABLE SETPOINTS:

Adjustable Setpoints are stored in RAM (random access memory) and are easily changed in the field.

CAUTION Adjustable Setpoints are lost if power is interrupted and the battery is not fully charged. To facilitate reentry, we suggest that a list of Adjustable Setpoints be affixed to one end of the microprocessor cabinet for reference. For your convenience, a blank Adjustable setpoints display which may be photocopied has been provided (See page 10).

NOTE: The following procedure also applies to the changing of the Security, Setback, and Auto Cycle display setpoints.

1. Press the [**CHANGE**] key to rotate the display to the Adjustable Setpoints display.
2. Press the [**STEP**] key to move or step a set of flashing brackets through the various setpoints. A setpoint is selected for change or update when it is enclosed by the flashing brackets.

NOTE: The DAY indicator, itself, will flash when selected for change or update.

3. Having selected the setpoint to be changed, the [**NUMERIC KEYPAD**] may be used to enter the new setpoint. **NOTE: All digits must be entered, including zeros. For example, (01.0).**

NOTE: The DAY, AUX 1, and AUX 2 setpoints, once selected, are changed or updated by pressing the [CHANGE] key.

NOTE: Certain setpoints may be reported in either pounds per square inch gauge (g) or inches of mercury (hg). To toggle between (g) and (hg), having selected the setpoint, press the [+/-] key to toggle between (g) and (hg).

4. In the event that an incorrect setpoint is keyed in all or part, press the [**CLEAR**] key to restore the original setpoint. Pressing the [**CLEAR**] key a second time will eliminate the flashing brackets.

5. Having keyed the desired setpoint, press the [**ENTER**] key. The new setpoint will be entered and the flashing brackets will move or step to the next setpoint.

NOTE: A setpoint entry outside the parameters of the Adjustable Setpoint display will be refused and the original Adjustable setpoint will be restored.

NOTE: To clear any time values [STEP] to the desired setpoint, press [CHANGE] and then press [CLEAR].

HOW TO DETERMINE ADJUSTABLE SETPOINTS:

Adjustable Setpoints should reflect values compatible with normal system operation. Too high a Low Suction Pressure Alarm setpoint may cause nuisance prealarms. Similarly, cutout setpoints should not fall within what are considered normal plant operation. As a rule of thumb, set the Low Suction Pressure Alarm 5 PSIG lower than the lowest normal suction pressure. The Low Suction Pressure Cutout should be 5 to 10 PSIG lower than the Low Suction Pressure Alarm setpoint.

The High Discharge Pressure Cutout should be set at 90% of the setting of the lowest high side relief valve. The High Discharge Pressure Alarm should be set 10 PSIG lower than the Cutout.

The Capacity Control setpoint should be the equivalent of the normal suction condition.

FIXED SETPOINTS DISPLAY *

FIXED SETPOINTS:	HIGH STAGE PRELUBE OIL PUMP PGM/A
Hi Disch Cut----	[212F]
Hi Disch Alarm--	[194F] Liq Inj Con 113F
Hi Oil Temp Cut-	[167F] Filter-----[25]
Hi Oil Temp Alarm	[158F] Oil Heater [113F]
Lo Oil Temp Cut--	[49F] Lo Oil Cut-[030]
Lo Oil Temp Alarm	[58F] Lo Oil Alrm[025]

The Fixed Setpoints display lists all fixed setpoints, program version, plus low oil alarm and low oil cutout setpoints. Fixed Setpoints define the limits of acceptable compressor operation. Fixed Setpoints are factory determined, stored in programmed memory (PROM), and will remain in memory if power to the microprocessor is interrupted.

HI DISCH CUT - The High Discharge Temperature Cutout, reported in degrees Fahrenheit, will shut down the compressor if the discharge temperature equals or exceeds this setpoint.

HI DISCH ALARM - The High Discharge Temperature Alarm, reported in degrees Fahrenheit, will trigger a prealarm if the discharge temperature equals or exceeds this setpoint.

HI OIL TEMP CUT - The High Oil Temperature Cutout, reported in degrees Fahrenheit, will shut down the compressor if the oil temperature equals or exceeds this setpoint.

HI OIL TEMP ALARM - The High Oil Temperature Alarm, reported in degrees Fahrenheit, will trigger a prealarm if the oil temperature equals or exceeds this setpoint.

LOW OIL TEMP CUT - The Low Oil Temperature Cutout, reported in degrees Fahrenheit, will shut down the compressor if the separator oil temperature equals or falls below this setpoint.

LOW OIL TEMP ALARM - The Low Oil Temperature Alarm, reported in degrees Fahrenheit, will trigger a prealarm if the separator oil temperature equals or falls below this setpoint.

HIGH STAGE or BOOSTER - Compressor application indicator.

PRELUBE, FULL LUBE, or CYCLING - Pump type will be indicated.

PGM/ - Microprocessor Program version.

LIQ INJ CON - The Liquid Injection Control, reported in degrees Fahrenheit, will shut off the liquid refrigerant supply to the compressor if the oil temperature equals or falls below this setpoint.

FILTER - The Oil Filter setpoint will trigger an alarm when the differential pressure across the oil filter equals or exceeds 25 pounds per square inch (PSI) for 15 seconds, or longer.

OIL HEATER - The Oil Heater setpoint, reported in degrees Fahrenheit, turns on the oil separator heater(s) when the oil temperature equals or falls below this setpoint whenever the compressor is **NOT** running.

Compressor Differential Cutout - The differential cutout has been lowered from 55 lb to 25 lb. Cutout will occur after five minutes. To allow operation at low differential pressures, the micro will take the following steps:

A. Force unload the compressor to 50% and display an "F Unload" when the oil pressure is within 10 lb of the main oil injection port pressure and the slide valve position is greater than 50%.

B. Prohibit the compressor from loading and display a "Ld Inhib" message when the differential is within 15 lb of the main oil injection port pressure.

Oil Pressure Alarm and cutout - Logic has been revised to same logic as currently used on RXB/RXF. The new logic is as follows:

Prelube and Cycling Oil Pump version when pump is not running. Alarm will occur if oil pressure is 25 lb below discharge pressure or within 10 lb of suction pressure for 30 seconds. Cutout occurs if oil pressure is 30 lb below discharge pressure or if oil pressure is within 7 lb of suction pressure for 10 seconds and alarm has already been set.

Full Lube and Cycling Oil Pump version when oil pump is running. Alarm occurs if oil pressure is within 10 lb of discharge pressure for 30 seconds. Cutout occurs when oil pressure is within 5 lb of discharge pressure for 10 seconds and oil pressure alarm has been set.

Cycling Oil Pump Control - The oil pump will cut off when differential pressure between suction and discharge pressure is 55 lb or greater. Upon pump termination the above cutout logic (pump not running) is utilized. Pump cut-in occurs when the differential pressure between suction and discharge is 45 lb or less. Oil pressure alarm and cutout logic (pump running) begins after a 30 second delay which allows the oil pump to build pressure.

*Display for illustrative purposes only.



ANNUNCIATOR DISPLAY *

ANNUNCIATOR: PG-1	Thu 10-01-87 15:33:36
(Use STEP key to advance PAGE)	
High Press. Cutout	*****
High Press. Alarm	*****
Low Press. Cutout	*****
Low Press. Alarm	*****
Oil Press. Cutout	*****
Oil Press. Alarm	*****

ANNUNCIATOR: PG-2	Thu 10-01-87 15:33:36
(Use STEP key to advance PAGE)	
Hi Oil Temp Cutout	*****
Hi Oil Temp Alarm	*****
Low Temp Cutout	*****
Low Temp Alarm	*****
Disch. Temp Cutout	*****
Disch. Temp Alarm	*****

ANNUNCIATOR: PG-3	Thu 10-01-87 15:33:36
(Use STEP key to advance PAGE)	
Comp. Auxiliary	*****
Pump Auxiliary	*****
Oil Level	*****
Comp. Differential	*****
Dirty Filter	*****

ANNUNCIATOR: PG-4	Thu 10-01-87 15:33:36
(Use STEP key to advance PAGE)	
Aux. 1 (Alarm)	*****
Aux. 2 (Shutdown)	*****
Low Motor Amps	
Sensor Fault	

When a prealarm or cutout occurs, a flashing **ALARM** or **CUTOUT** indicator will appear in the lower right hand corner of the Operating display. To determine the fault, rotate to the Annunciator display by pressing the **[CHANGE]** key.

The Annunciator display lists all key operative points on four sequential displays. These displays can be rotated from page #1 through page #4 by pressing the **[STEP]** key. When a prealarm or cutout is triggered, the pertinent point will flash, and the time of the occurrence will be recorded to the right of the alarm. Prealarms are self-clearing. At this time the alarm will stop flashing, but the time of the first occurrence will still be recorded to the right of the alarm. Pressing the **[CLEAR]** key while at the Annunciator display will clear all alarms and/or cutouts.

In order to restore the Annunciator display and resume normal operation it will be necessary to go through the following steps:

1. Correct the conditions causing the alarm.
2. Press the **[ALARM SILENCE]** key. (This action may precede correcting the conditions causing the alarm).
3. To clear or reset the Annunciator pages, press the **[CLEAR]** key. This will also clear the ALARM or CUTOUT indicator from the Operating display.

4. Press **[F1]** to call up the Operating display. If the conditions causing the alarm have not been corrected or a new fault has occurred, a new ALARM or CUTOUT message will appear.

NOTE: Use of the Emergency Stop Button may trip one or more alarm setpoints.

SHUTDOWN RECORD DISPLAY *

SHUTDOWN RECORD:	Thu 10-01-87 15:33:36
(Use STEP key to advance PAGE)	
Hi Oil Temp Cutout	Wed 09-30-87 16:22:54
Comp Auxiliary	Sat 08-22-87 09:47:02
Low Temp Cutout	Thu 08-20-87 11:17:33
Pump Auxiliary	Mon 08-17-87 18:53:11
Disch. Temp Cutout	Tue 07-14-87 06:22:09
Oil Pres Cutout	Fri 07-08-87 14:06:21

The Shutdown Record display keeps a record of the last six shutdowns (cutouts). This information will help troubleshoot persistent operational problems. The most recent cutout will appear on the top line of the display with the oldest appearing on the last or bottom line. When a cutout occurs, all information is moved down one line and the new cutout appears at the top. When the display is full, the oldest record is dropped off the display and is not retained in memory. The information presented is echoed from the Annunciator display; providing the type of cutout, the day, the date, and the time. **NOTE: This information will not be lost due to power failure.**

FREEZE DISPLAY *

FREEZE DISPLAY:	Thu 10-01-87 15:33:36
Suction Disch Oil Filter Compressor	
20.0 g 225 g 170 g 01PSID OFF Mode	
+015 F 140 F 135 F RECYCLE	
V Ratio S V Pos Pump %FLA Sep 132 F	
4.6 090% OFF 080% HTR off	
Auto Auto CUTOUT	
C.C.=20.0 g	

The Freeze display has the same appearance and contains the same information as the Operating display. (For a description of the information presented by the Freeze display, refer to the Operating display.) The Freeze display freezes the information of the Operating display **AT THE MOMENT OF A COMPRESSOR CUTOUT**. The information on the Freeze display can help the operator to identify the cause of a fault which occurred when no one was present. The Freeze display will retain the information generated by a cutout until a new cutout occurs or power is removed from the microprocessor.



Do not confuse the Freeze display with the Operating display. In order to avoid confusion remember that

the displayed information on the Operating display is constantly being updated and changed. The Freeze display is fixed and FREEZE DISPLAY appears in the upper left hand corner of the display.

NOTE: The Freeze display will appear as a blank screen when power is initially furnished to the unit, and it will return to a blank screen anytime power is removed from the microprocessor.

*Display for illustrative purposes only.

SECURITY DISPLAY *

SECURITY DISPLAY: Thu 10-01-87 15:33:36
Setpoints Access---[Enabled] Keyboard
Enter Access Code---[*****]
Press F2 To Exit

The [F2] function key will call up the Security display. The Security display allows the operator to either enable or disable the microprocessor's keyboard and, thereby, prevent unauthorized tampering with the various adjustable setpoints. When enabled, the microprocessor keyboard is fully operative and the security lockout is not in effect. When disabled, the keyboard is rendered partially nonfunctional. All displays will still be accessible through the keyboard. If any attempt is made to enter new adjustable setpoints, however, the microprocessor will default to the Security display.

TO ENABLE THE KEYBOARD, press the [STEP] key so that the brackets beside Enter Access Code flash, key the proper five digit access code, and press [ENTER]. The Setpoints Access will toggle from disabled to enabled and adjustable set point entry is now possible.

TO DISABLE THE KEYBOARD, press the [F2] function key to call up the Security display. Press the [STEP] key until the brackets beside Enter Access Code flash, key the proper five digit access code, and press [ENTER]. Now, press the [STEP] key until the brackets beside Setpoints Access flash and press the [CHANGE] key to toggle from enabled to disabled.

TO CHANGE THE ACCESS CODE, press the [F2] function key to call up the Security display. Press the [STEP] key until the brackets beside Enter Access Code flash, key the proper five digit access code, and press [ENTER]. Now, select the Enter Access Code a second time by pressing the [STEP] key until the brackets beside Setpoints Access flash, key in the new five digit access code, and press [ENTER].

NOTE: Power loss will not effect the Security display.

NOTE: IF NO ACCESS CODE WAS ENTERED AND THE DISABLED COMMAND WAS SELECTED, THE ACCESS CODE IS [00000].

LOST OR FORGOTTEN ACCESS CODE: Consult Frick Company for assistance.

SETBACK DISPLAY *

SETBACK DISPLAY: Thu 10-01-87 15:33:36
Press F1 To Exit
Setback Setpoint-[05.0 g] Active-[No]
Start Stop Start Stop
Mon-[--:--]-[06:00] Fri-[16:00]-[---:--]
Tue-[--:--]-[--:--] Sat-[--:--]-[---:--]
Wed-[--:--]-[--:--] Sun-[--:--]-[---:--]
Thu-[--:--]-[--:--]

*Display for illustrative purposes only.

The [F3] function key will call up the Setback display. The Setback feature enables automatic operation at two separate suction conditions on a preset time schedule. Having entered the desired Setback setpoint, enter the start and stop time or times, and select Active: (Yes) or (No).

NOTE: To change the Setback setpoints, refer to "TO CHANGE THE ADJUSTABLE SETPOINTS"

AUTO CYCLE DISPLAY *

AUTO CYCLE DISPLAY: Thu 10-01-87 16:33:36
Press F1 To Exit
Suction Pressure-----[20.0 g]
Compressor Start-----[20.0 g]
Compressor Stop-----[18.0 hg]
Minimum Slide Valve-----[00%]
Auto Cycle Active-----[No]

The Auto Cycle display provides for independently adjustable setpoints to turn the compressor on and off in response to the suction pressure or as an adjustable setpoint to limit the minimum slide valve position.

NOTE: To change the Auto Cycle setpoints, refer to "TO CHANGE THE ADJUSTABLE SETPOINTS"

SUCTION PRESSURE - Constantly monitors and displays the suction pressure in pounds per square inch gauge (g) or inches of mercury (hg).

COMPRESSOR START - Compressor Start-up will bring the compressor back on line when the suction pressure rises to the displayed setpoint.

COMPRESSOR STOP - Compressor Stop will shut down the unit if the suction pressure drops to or below the displayed setpoint limit. **NOTE:** This limit must be set higher than Low Suction Pressure Cutout and the Low Suction Pressure Alarm setpoints.

MINIMUM SLIDE VALVE - Minimum Slide Valve Position, shown as a percentage, will limit the slide valve position to the displayed setpoint.

AUTO CYCLE ACTIVE - Indicates whether Auto Cycle is active (YES) or not active (NO). Press the [CHANGE] key while at this setpoint to change the status. Upon deactivation, the compressor will return to the previous mode of operation.

ANALOG OFFSET DISPLAY*

ANALOG OFFSET:	Suc	Disch	Oil	Sep	Filt	Spare	Econ
Temp	+0	+0	+0	+0		+0.0	
Pres	+0.0	+0	+0		+0		+0
Channel	10	12	13				
Press	+0	+0	0				

The Analog Offset Display is accessed by pressing +/- key. All analog values can be offset + or - 3 to 9 units depending on which value is being adjusted. Use the [STEP] key to step to the desired setpoint. Press the [CHANGE] key to change the value of the offset by 1. The actual analog value will be displayed on the top line of the display. The "Econ" and channels 10, 12, 13 are displayed but do not pertain to the standard program.



Sensor Fault Failure - A "Sensor Fault" cutout was added to the program to stop the compressor if a temperature or pressure sensor is at its minimum or maximum limit for 5 seconds. The following channels and conditions will cause this cutout:

- Channel 1 - Suction Temp Low or High (-67 to 113°F)
- Channel 2 - Low or High Discharge Temp (32 or 212°F)
- Channel 3 - Low or High Oil Temp (0 or 180°F)
- Channel 4 - Low or High Separator Temp (0 or 180°F)
- Channel 6 - Low or High Oil Pressure (<0 g or 285 g)
- Channel 8 - Low or High Discharge Pressure (<0 g or 285 g)
- Channel 9 - Low Suction Pressure (29 hg only)

Pulse Load Signal at 100% Slide Valve Position - This new feature will stop loading the compressor when 100% slide valve is displayed. The load signal will pulse for 2 seconds every minute when the slide valve is at 100% and the pressure is above setpoint.

TEMPERATURE-PRESSURE CONTROL PROGRAM (OPTION)

NOTE: The following displays are provided only when the Temperature-Pressure Control Program option has been ordered with the RWB II Plus Rotary Screw Compressor Unit.

SETPOINTS DISPLAY PAGE 1 *

SETPOINTS PAGE 1 Capacity Control=Press						
C.C.	CUTOUT	ALARM	PB	DB	CT	
Press 25.3g	01.3g	05.3g	10	1.0	10	
Temp +40.0F	+32.0F	+33.0F	10	0.5	10	
offset-act						
Sup Heat-Alarm-10F-no						
Sep Cond-Alarm-10F-no						

* Display for illustrative purposes only.

The Setpoints Display is accessed by pressing the [CHANGE] key.

CONTROL - This setpoint is used to select either Pressure Capacity Control or Temperature Capacity Control. **NOTE:** There are only two setpoints, press for pressure capacity control and temp for temperature capacity control.

CC - The capacity control setpoint is for normal operation, not setback.

CUTOUT - This setpoint will stop the compressor if the suction pressure drops below the pressure setpoint for 90 seconds or if the CC Temperature drops below the temperature setpoint. There is no time delay on the temperature cutout.

ALARM - An alarm will be activated if the suction pressure drops below the pressure setpoint or if the CC Temperature drops below the temperature setpoint. There is no time delay for either.

PB - The Proportional Band (PB) is used to determine the amount of time the load/unload solenoid is energized, according to how far away from the setpoint the actual control pressure or temperature is. The smaller the number, the more load/unload will be sent. A PB of 10% is default. It is adjustable to 2, 5, 10, 15, 20, or 25 percent.

DB - The Dead Band (DB) is a + (plus) or - (minus) value above or below the setpoint which the compressor will neither load nor unload. It is adjustable between .5 and 5.0 psig or degrees, in increments of .5 units.

CT - The Cycle Time (CT) setpoint is the amount of time between the beginning of each load/unload response. It is adjustable to 5, 10, 15, 20, 25, or 30 seconds.

Use the [STEP] key to step to the desired setpoint, then press the [CHANGE] key to change the CC, PB, DB and CT values. Enter the desired value for the remaining setpoints and press [ENTER] when complete.

ADJUSTABLE SETPOINTS FORM

ADJUSTABLE SETPOINTS: ID = []	[- -]
Cap. Control — []	Thu [: :]
Lo Suct Cutout — []	Baud — []
Lo Suct Alarm — []	
Hi Disch Cutout — []	Aux 1 [] []
Hi Disch Alarm — []	Aux 2 [] []
M.L.C. Stop Load — []	CT Factor — []
M.L.C. Force Unld — []	Recy. Delay — []

Photocopy and fill in applicable data for your unit. Retain for reference if reentry is required.

TEMPERATURE-PRESSURE CONTROL PROGRAM (OPTION) (continued)

The new setpoints provided on this display allow monitoring of compressor superheat and condensing in the separator. The following setpoints apply to the monitoring of the superheat and condensing in the separator.

ALARM/(SHUTDOWN) -The Alarm/(shutdown) setpoints select the conditions for an alarm or shutdown. If alarm is selected, the alarm will occur after a 30 second delay. If shutdown is selected, the shutdown will occur 60 seconds after the alarm.

OFFSET - This setpoint is the degrees F above the saturation point temperature where the alarm or shutdown will occur.

ACT - The function selects whether the alarm/shutdown is activated or not.

Use the [STEP] key to step to the desired setpoint, then press the [CHANGE] key to change the setpoint. Press [ENTER] when all desired setpoint changes have been made.

SETBACK DISPLAY *

```

SETBACK DISPLAY:   Tue 04-10-90 08:44:50
Press Setpoint-[25.3g ]      F1 To Exit
Temp Setpoint-[+50.0F]      Active-[No ]
  Stop   Start           Start   Stop
Mon-[-:-]-[-:-]   Fri-[-:-]-[-:-]
Tue-[-:-]-[-:-]   Sat-[-:-]-[-:-]
Wed-[-:-]-[-:-]   Sun-[-:-]-[-:-]
Thu-[-:-]-[-:-]
    
```

The Setback Display is accessed by pressing the [F3] key.

PRESS SETPOINT - The capacity control setpoint used when in the Setback mode and Pressure is selected as the capacity control desired.

TEMP SETPOINT - The capacity control setpoint used when in the Setback mode and Temperature is selected as the capacity control desired.

NOTE: To change the Setback setpoints, refer to "TO CHANGE THE ADJUSTABLE SETPOINTS".

The Auto Cycle display provides for independently adjustable setpoints to turn the compressor on and off in response to the suction pressure or as an adjustable setpoint to limit the minimum slide valve position. The compressor can be started and stopped by the following pressure setpoints even if the capacity control is selected to temperature.

AUTO CYCLE PRESS CONTROL DISPLAY *

```

AUTO CYCLE PRESS   Tue 04-10-90 08:44:57
DISPLAY:           Press F1 To Exit
Suction Pressure-----[06.5 g ]

Comp Start - [99.0 g ] Timer-[00 min]
Comp Stop- [29.0 hg] Timer-[00 min]
Min SV---[50%]
Active---[No ]      * for Temp Menu
    
```

NOTE: To change the Auto Cycle setpoints, refer to "TO CHANGE THE ADJUSTABLE SETPOINTS"

SUCTION PRESSURE - Constantly monitors and displays the suction pressure in pounds per square inch gauge (g) or inches of mercury (hg).

COMP START - The suction pressure must be greater than or equal to the "START" setpoint in order to start the compressor. This setpoint works in conjunction with the "TIMER" setpoint located to the right of it on the display.

TIMER - This is a time delay used to start the compressor. The timer only accumulates time whenever the pressure rises to or above the "START" setpoint and will reset if the pressure drops below the "START" setpoint.

COMP STOP - Compressor Stop will shut down the unit if the suction pressure drops to or below the displayed "STOP" setpoint limit. This setpoint works in conjunction with the "TIMER" setpoint located to the right of it on the display.
NOTE: This limit must be set higher than Low Suction Pressure Cutout and the Low Suction Pressure Alarm setpoints.

(STOP) TIMER - The (stop) TIMER is a time delay used to stop the compressor. The timer only accumulates time whenever the pressure drops to or below the "STOP" setpoint and will reset if the pressure rises above the "STOP" setpoint.

MINIMUM SLIDE VALVE - Minimum Slide Valve Position, shown as a percentage, will limit the slide valve position to the displayed setpoint.

ACTIVE - Indicates whether Auto Cycle is active or not. Press the [CHANGE] key while at this setpoint to change the status. Upon deactivation, the compressor will return to the previous mode of operation.

AUTO CYCLE TEMP CONTROL DISPLAY *

```

AUTO CYCLE TEMP   Tue 04-10-90 08:45:40
DISPLAY:           Press F1 To Exit
Cap Control Temperature-[+50.5 F]

Comp Start-[+50.0 F]   Timer-[01 min]
Comp Stop-[+20.0 F]   Timer-[01 min]
Min SV---[50%]
Active---[Yes]        * for Press Menu
    
```

The Auto Cycle Temperature Control Display is accessed by pressing F4 and then the * keys. **NOTE: The compressor can be started and stopped by the following temperature setpoints even if the capacity control is selected to pressure.**

CAP CONTROL TEMPERATURE - Constantly monitors and displays the suction temperature.

COMP START - The CC (capacity control) Temperature must be greater than or equal to the "START" setpoint in order to start the compressor. This setpoint works in conjunction with the "TIMER" setpoint located to the right of it on the display.

(Start) TIMER - This is a time delay used to start the compressor. The timer only accumulates time whenever the CC Temperature rises to or above the "START" setpoint and will reset if the CC Temperature drops below the "START" setpoint.

*Display for illustrative purposes only.



COMP STOP - The CC Temperature must be less than or equal to the “STOP” setpoint in order to stop the compressor. This setpoint works in conjunction with the “TIMER” setpoint located to the right of it on the display.

(STOP) TIMER - The (stop) TIMER is a time delay used to stop the compressor. The timer only accumulates time whenever the CC Temperature drops to or below the “STOP” setpoint and will reset if the CC Temperature rises above the “STOP” setpoint.

MINIMUM SLIDE VALVE - Minimum Slide Valve Position, shown as a percentage, will limit the slide valve position to the displayed setpoint.

ACTIVE - Indicates whether Auto Cycle is active or not. Press the [CHANGE] key while at this setpoint to change the status. Upon deactivation, the compressor will return to the previous mode of operation.

LEAD-LAG OPTION

The lead-lag compressor sequencing option provides the controls for operating two RWB II compressors in one system.

AUTO CYCLE DISPLAY *

AUTO CYCLE	Tue 04-10-90 08:44:57
DISPLAY:	Press F1 To Exit
Suction Pressure-----	[06.5 g]
Comp Start - [99.0 g]	Timer-[00 min]
Comp Stop- [29.0 hg]	Timer-[00 min]
Min SV—[50%]	Lead-[YES]
Active—[No]	

*Display for illustrative purposes only.

The software includes user adjustable setpoints on the Auto Cycle setpoints screen (F4 on Main Menu) for the following:

START - The suction pressure must be greater than or equal to the “START” setpoint in order to start the compressor. This setpoint works in conjunction with the “Timer” setpoint located to the right of it on the Auto Cycle setpoints screen.

TIMER - This is a time delay used to start the compressor. The timer only accumulates time whenever the pressure rises to or above the “START” setpoint and will reset if the pressure drops below the “START” setpoint.

STOP - The suction pressure must be less than or equal to the “STOP” setpoint in order to stop the compressor. This setpoint works in conjunction with the “Timer” setpoint located to the right of it on the Auto Cycle setpoints screen.

TIMER - This is a time delay used to stop the compressor. The timer only accumulates time whenever the pressure drops to or below the “STOP” setpoint and will reset if the pressure rises above the “STOP” setpoint.

MIN SV -This setpoint is the minimum slide valve position, shown as a percentage, it will limit the slide valve position to the displayed setpoint.

LEAD - This setpoint assigns the compressor as the lead or the lag unit. Press the [CHANGE] key while at this setpoint to change the status.

ACTIVE - This setpoint indicates whether the Auto Cycle Mode is active or not. Press the [CHANGE] key while at this setpoint to change the status.

OPERATION

For operation of the LEAD-LAG sequence, both units must be in Auto Cycle compressor mode, one compressor micro selected as the LEAD compressor, the other compressor selected as the LAG compressor and the slide valves in Auto mode.

With NO Compressor Running

The lead will start when its “START” setpoint is reached for the amount of time selected for the “TIME” setpoint.

With ONE Compressor Running

If the load rises:

The lag compressor will start when its “START” setpoint is reached for the amount of time selected for the “TIME” setpoint and the lead compressor is running at 100% slide valve or running with the motor load inhibit or lead cutout or lead in recycle.

If the load falls:

The lead compressor will stop when its “STOP” setpoint is reached for the amount of time selected for the “TIME” setpoint.

With TWO Compressors Running

If the load rises:

The lead and lag compressor will load independently.

If the load falls:

The lag compressor will unload to its “MIN SV” setpoint. Then the lead compressor will unload to its “MIN SV” setpoint. The lag compressor will stop when the suction pressure drops below the “STOP” setpoint for the amount of time selected for the “TIME” setpoint.

NOTE: Be careful not to select both compressors as lead compressors or as lag compressors as improper operation will result.

NOTE: One compressor will operate as a normal auto cycle compressor when any one of the following occurs:

- a. Power is removed from one of the two compressors,
- b. Either of the compressors is NOT selected to “AUTO”, or
- c. If communications is lost between the compressors for any reason.

COMMUNICATIONS TROUBLESHOOTING

Troubleshooting the communications:

Go to the FIXED SETPOINTS PAGE by using the "CHANGE" key and the "*" key. The display will appear as:

FIXED SETPOINTS DISPLAY *

FIXED SETPOINTS:	HIGH STAGE PRELUBE
COMM ACTIVITY-[] OIL PUMP PGM/A
Hi Disch Cut----	[212F]
Hi Disch Alarm--	[194F] Liq Inj Con 113F
Hi Oil Temp Cut-	[167F] Filter-----[25]
Hi Oil Temp Alarm	[158F] Oil Heater [113F]
Lo Oil Temp Cut--	[49F] Lo Oil Cut-[030]
Lo Oil Temp Alarm	[58F] Lo Oil Alrm[025]

If the microprocessor is receiving information in the communications port from the other compressor, a "2" will flash between the brackets. During normal operation a "2" will flash every 5 seconds.

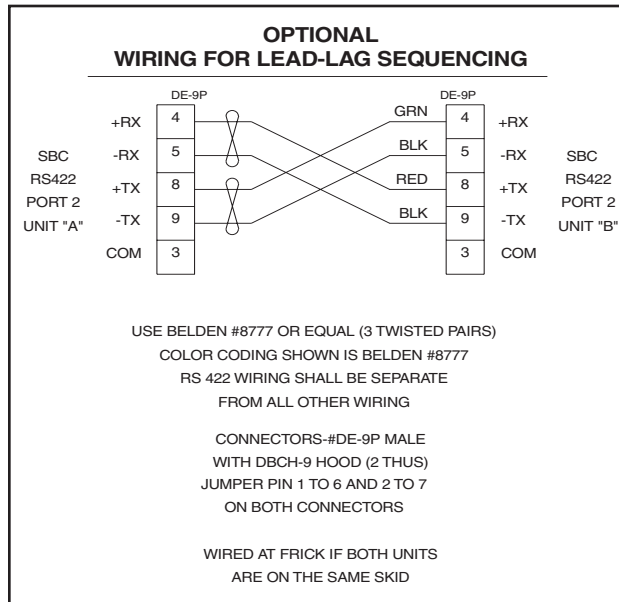

NOTE: WHEN USING THE RS422 PORTS FOR LEAD-LAG, THEY CANNOT BE USED FOR ANY OTHER COMMUNICATIONS.

At the same time information is display on the lower right hand corner of the Auto Cycle display concerning the lead-lag information:

AUTO CYCLE DISPLAY *

AUTO CYCLE	Tue 04-10-90 08:44:57
DISPLAY:	Press F1 To Exit
Suction Pressure-----	[06.5 g]
Comp Start - [99.0 g }	Timer-[00 min]
Comp Stop- [29.0 hg]	Timer-[00 min]
Min SV—[50%]	Lead-[YES]
Active—[No]	0111 111

This information is either "0" or "1" and represents what is being sent from the other compressor. Consult Frick Company if additional information is required.

**HOW THE MICROPROCESSOR WORKS
- SUMMARY -**

The Frick microprocessor has 4 major components and a variety of sensors. The major components are the SBC (single board computer), two display screens, and the keyboard.

The SBC can be considered the brain of the microprocessor control console. The SBC contains the logic center which provides the rules by which the microprocessor will operate, the integrated circuit chips which store the burned-in memory of how the compressor unit is to behave, an analog input to convert VDC from the various sensors into computer binary language, and RAM (random access memory) integrated circuit chips to store information which can be readily changed by the microprocessor or, as in the case of adjustable setpoints, by the operator. The SBC collects information, processes the information, and delivers instructions to the displays and to the output modules.

The SBC gathers information from several sources on the compressor unit. Pressure transducers sense changes in pressure and return a variable DC voltage of 1 to 5 VDC to the SBC. The signals are converted into binary code which the microprocessor understands. The microprocessor scans the incoming data many times per second and compares the information it receives with the instructions programmed in the PROM chips, information stored in the RAM chips, and instructions it has received from the console keyboard. As operating conditions change, the microprocessor also forwards the information it is receiving to the display screen. When an operating condition or conditions develop which the microprocessor program identifies as requiring a specific action, the microprocessor generates an instruction which is forwarded to the output modules. The instruction triggers a solid state output device capable of handling control voltage and the instruction is executed. In some cases, such as load and unload instructions, the computer displays the instruction on the Operating display with an L (load) or U (unload) symbol at the same time as the appropriate output is energized.

If the microprocessor receives information that indicates an abnormal operating condition has been reached or is present, it will generate one or more of the following instructions:

1. If a subsystem on the compressor unit, such as the oil heater(s) or liquid injection, can correct the problem, the microprocessor will energize or deenergize this system.
2. If a prealarm setpoint has been reached the microprocessor will trigger the prealarm and display this information on the Operating display and the Annunciator display.
3. If a cutout setpoint has been reached, the microprocessor will shut down the compressor. The microprocessor will indicate **CUTOUT** on the Operating display and the information present on the Operating display at the moment of cutout will be stored and can be retrieved by rotating displays to the Freeze display. Additional information will be available through the Annunciator and Shutdown Record displays.

* Display for illustrative purposes only.

A typical example of how the microprocessor responds can be illustrated by the responses generated by the microprocessor as oil temperature increases. Assume that the ambient temperature and compressor unit temperature are 45°F and you have just pressed the [RUN] key to start the compressor unit:

AT 45° F.

The microprocessor receives information that the oil temperature is below 49°F, the Low Oil Temperature Cutout setpoint, and shuts down the unit. The microprocessor will prevent the compressor package from running. The microprocessor also instructs the oil heater(s) output to energize the oil heater(s).

AT 50° F.

When the oil temperature reached 50°F the microprocessor would allow the Low Oil Temperature Cutout to be cleared and the compressor unit could now be started. (Assume that the [RUN] key has been pressed and that the compressor has now started.) The Low Oil Temperature Alarm would still be engaged and cannot be cleared until oil temperature exceeds 58°F. The oil heater(s) shut off on compressor start.

AT 113° F

The microprocessor instructs the liquid-injection solenoid output to deenergize the liquid-injection solenoid.

AT 122° F

The microprocessor instructs the liquid-injection solenoid output to energize.

AT 110° F TO 150° F.

Normal operating range. The microprocessor continues monitoring oil temperature and reporting this information on the Operating display.

AT 158° F.

The microprocessor triggers the High Oil Temperature Alarm and displays the alarm on the Operating display and the Annunciator display.

AT 167° F.

The microprocessor instructs the compressor motor to shut down and displays a **CUTOUT** indication on the Operating display. It stores the operating conditions at the moment of cutout in the Freeze display. Information regarding the cutout will also be retained by the Annunciator and the Shutdown Record displays.

NOTE: If the operator makes an error by attempting to start the compressor under conditions outside safe normal operating conditions, the microprocessor will prevent start-up and advise the operator of the fault.

MULTIPLE COMPRESSOR SEQUENCING FOR RWB II COMPRESSOR UNITS WITH MICROPROCESSOR CONTROLS

A - The standard microprocessor panel includes:

1. Remote Run Input
2. Remote Load Input
3. Remote Unload Input

The remote run input is only recognized when the remote run mode has been selected by pressing the "remote start" key on the front panel of the microprocessor.

The remote load and unload inputs can only be recognized when the "remote" key in the slide valve column on the front panel of the microprocessor has been pressed.

B - If master sequencing between multiple compressors in parallel on a common suction is desired. This output data will permit the compressor microprocessor to be interfaced with a master sequence controller. See electrical diagram for details.

SUGGESTED PROGRAMMABLE CONTROLLER PROGRAM TO DECODE MICROPROCESSOR OUTPUT DATA CODES

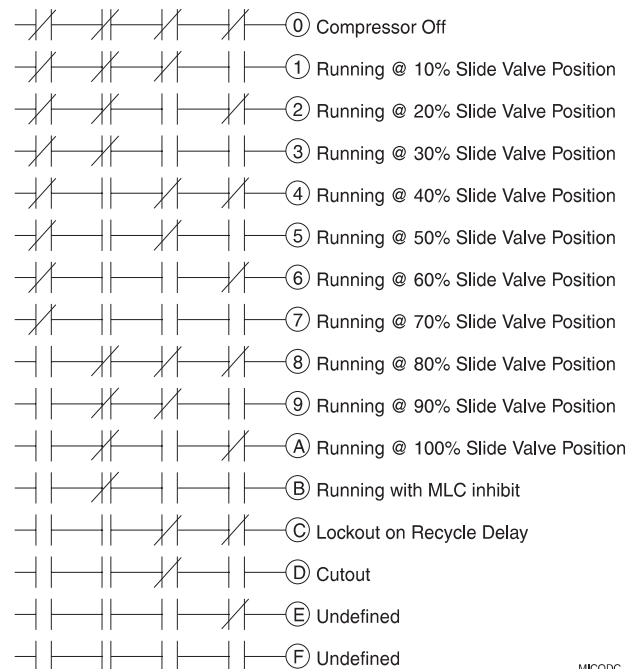

MICODC

OUTPUT NO.	16	15	14	13	HEX CODES	
TERMINAL NO.	31	32	33	34		
MNEMONIC	BIT 3	BIT 2	BIT 1	BIT 0		
MEANING	OUTPUT DATA CODE					
Compressor Off	0	0	0	0	0	
Running Slide Valve Posi- tion	10%	0	0	0	1	
	20%	0	0	1	0	2
	30%	0	0	1	1	3
	40%	0	1	0	0	4
	50%	0	1	0	1	5
	60%	0	1	1	0	6
	70%	0	1	1	1	7
80%	1	0	0	0	8	
90%	1	0	0	1	9	
100%	1	0	1	0	A	
Running with MLC Inhibit	1	0	1	1	B	
Lockout on Recycle Delay	1	1	0	0	C	
Cutout	1	1	0	1	D	
Undefined	1	1	1	0	E	
Undefined	1	1	1	1	F	

C - A master sequence controller must be installed to provide the signals to remote start and stop the compressors and remote load and unload the compressors based on the common suction pressure or other parameter and the compressor status based on the optional microprocessor output data feedback. The customer may supply his own master sequencer panel (usually a programmable controller) or Frick, can supply this sequencer if desired (contact Frick for pricing).

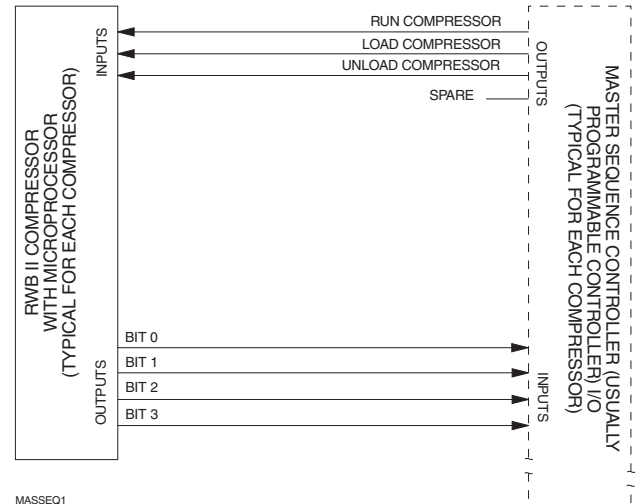

MICROPROCESSOR OUTPUT DATA CODE

A 3.5 K OHM, 10 watt resistor (RES) must be field installed, as shown below, when the 120 VAC outputs of the RWB II PLUS are driving 120 VAC solid state input devices such as programmable controllers.

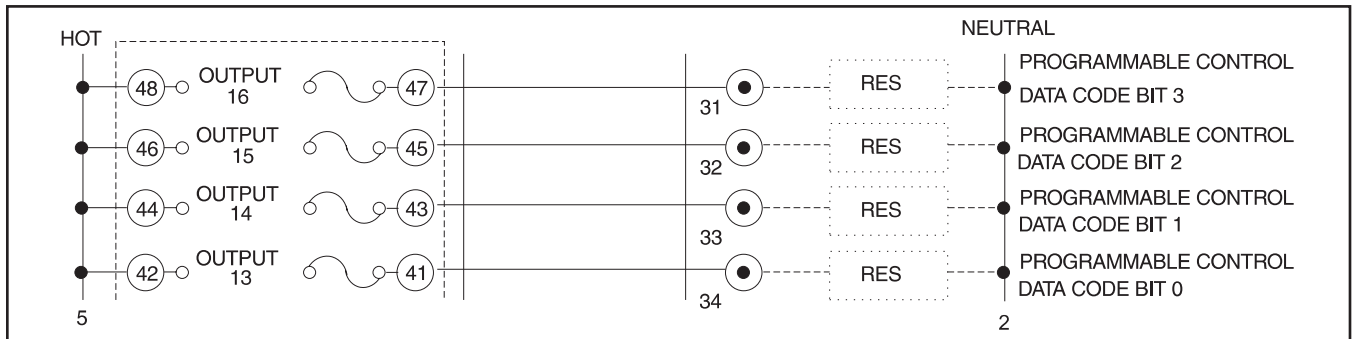

MICROPROCESSOR TELECOMMUNICATIONS



The following details are typical and may or may not match the software supplied on your compressor. The

telecommunications capabilities are continuously being expanded and improved. Therefore, you **MUST** consult **FRICK Company** for the exact details on your particular unit(s) before developing system software to interface with your compressors.

The Frick RWB II PLUS Microprocessor comes with an on board telecommunications interface. The telecommunications feature permits interfacing the microprocessor with a modem, remote data communications terminal, or master computer via RS-422 protocol. In the case of a modem, telephone lines are used for the actual transmission of data permitting communications from a remote location.

The components necessary to utilize the telecommunications feature will vary with the application. Information concerning these items may be obtained from Frick Company, Waynesboro, Pa.

COMMUNICATIONS PROTOCOL SPECIFICATIONS:

All commands must be in ASCII (CAPS) to be recognized. A compressor with an ID code of [00] is considered disabled. ID Codes from [01] through [99] are valid and are recognized by the microprocessor.

The following is a complete list of available command types:

COMMAND CODE and DESCRIPTION
I = Returns compressor status information.
R = Compressor start command.
S = Compressor stop command.
V = Compressor slide valve control command.
D = Compressors display screens command.
P = Return Pressures information.
T = Return Temperatures information.
A = Return full load amps information.
C = Enter Change setpoints mode.

The following is a detailed description of each command:

RETURN COMPRESSOR STATUS INFORMATION: #01I	
# Start of command sequence.	
01 Compressor ID code.	
I Return Status information command.	
RETURNED ANSWER, ie: 090RRRN340	
Character Description	Position of returned data
1,2,3 Slide valve position.	
4 Remote, Auto, Manual (slide valve)	
5 Delay-recycle, Running, Off.	
6 Rem, Man, Off, Auto (Compressor mode)	
7 Cutout, Alarm, Normal.	
8,9,10 Suction in PSIA.	
(Carriage return, line feed.)	

COMPRESSOR START COMMAND: #01R01	
# Start command sequence.	
01 Compressor ID code.	
R Start compressor command.	
01 ID code repeated for verification	
NOTE: The compressor must be in the remote start mode for this command to be executed.	
Returned answer: A01	
Character Description	Position of returned data
1 Acknowledge of command sent.	
2,3 ID code of compressor.	
(Carriage return, line feed.)	

COMPRESSOR STOP COMMANDS: #01S01	
# Start command sequence.	
01 Compressor ID code.	
S Stop compressor command.	
01 ID code repeated for verification	
NOTE: The compressor must be in the remote start mode for this command to be executed.	
Returned answer: A01	
Character Description	Position of returned data
1 Acknowledge of command sent.	
2,3 ID code of compressor.	
(Carriage return, line feed.)	

SLIDE VALVE CONTROL COMMANDS: #01VLXX #01VUXX #01VS	
# Start command sequence.	
01 Compressor ID code.	
V Compressor control command.	
L Load Slide valve command.	
U Unload slide valve command.	
XX = 00 Turns selected output off.	
XX = 01 to 15 Turns selected output on for XX seconds.	
XX = 99 Turns selected output on.	
S Return slide valve position value.	
If the command was #01VL00, then the load slide valve output on compressor #1 would be turned off. If the command was #01VL05, then the load slide valve output on compressor #1 would be turned on for 5 seconds, and would then automatically turn off. NOTE: the slide valve must be in the remote mode for this command to be executed.	
RETURNED ANSWER (for L or U commands): A01	
Character Description	Position of returned data
1 Acknowledge of command sent.	
2,3 ID code of compressor.	
(Carriage return, line feed.)	
RETURNED ANSWER (for S command), ie. 090	
1,2,3 Slide valve position.	

COMPRESSOR DISPLAY SCREENS COMMAND: #01DXN

Start command sequence.
01 Compressor ID code.
D Compressor control command.

X = 0 Operating display.
X = S Adjustable setpoints display.
X = D2 Adjustable setpoints Page 2.
X = X Fixed setpoints display.
X = R Shutdown record display.
X = F Freeze display.
X = C Autocycle display.
X = P Security display.
X = B Setback display.
X = + Analog offset display.
X = AN Annunciator display page "N"

N = 1 Display page #1. NOTE: "N" para-
N = 2 Display page #2. meter uses to
N = 3 Display page #3. access annunci-
N = 4 Display page #4. ator pages.

If the command was #01DA1, then the micro-processor would dump the annunciator display page number one. Display dumps consist of 336 characters each.

RETURN PRESSURES COMMAND: #01PX

Start command sequence.
01 Compressor ID code.
P Return pressures command.

X = S Return suction pressure (PSIA).
X = D Return discharge pressure (g/hg).
X = O Return oil pressure (g).
X = F Return filter differential pressure.
X = A Return all pressures.

If the command was #01PS, then the micro-processor would dump the suction pressure.

RETURNED ANSWER

XXX = 3 characters followed by a carriage return, line feed.

If using the "A" command, then the returned data would be:

XXXXXXXXXXXX = 12 characters followed by a carriage return, line feed.

RETURN FULL LOAD AMPS COMMAND: #01A

Start command sequence.
01 Compressor ID code.
A Return full load amps command.

If the command was #01A, then the micro processor would dump the full load amps value.

RETURNED ANSWER:

XXX = 3 characters followed by a carriage return, line feed.

RETURN TEMPERATURES COMMAND: #01TX

Start command sequence.
01 Compressor ID code.
T Return temperature command.

X = S Return suction temperature.
X = D Return discharge temperature.
X = O Return oil temperature.
X = P Return separator temperature.
X = A Return all temperatures as a string of data.

If the command was #01TS, then the micro-processor would dump the suction temperature.

RETURNED ANSWER:

XXX = 3 characters followed by a carriage return, line feed.

If using the "A" command, then the returned data would be:

XXXXXXXXXXXX = 13 characters followed by a carriage return, line feed.

NOTE: The "S" command will return four (4) characters followed by a carriage return, a line feed and "+ or - .xxx".

QUERY SETPOINTS DATA - #IDQ1 will return

Pos	#	Byte(s)	Setpoint (Name/Comment)
1		1	Always "0"
2,3,4,5		4	Ccsp. 3 chars followed by g or h
6,7,8,9		4	Low suct. press. cutout. 3 chars followed by g or h
10,11,12,13		4	Low suct. press. alarm. 3 chars followed by g or h
14,15		2	Prop. band
16,17		2	Dead band
18,19		2	Cycle time
20,21,22,23		4	Future
24,25,26,27		4	Future
28,29,30,31		4	Future
32,33		2	Future
34,35		2	Future
36,37		2	Future
38,39,40,41		4	Hpco
42,43,44,45		4	Hpa
46		1	ID (tenths position byte)
47		1	ID (ones position byte)
48		1	Checksum of all data (pos. 1 to 47)
49		1	CR code 13
50		1	LF code 10
51		1	0 null terminator char.



QUERY SETPOINTS DATA - #IDQ2 will return

Pos	#	Byte(s)	Setpoint (Name/Comment)
1,2,3	3		Future
4,5,6	3		Future
7,8,9	3		Mlc amps stop load
10,11,12	3		Mlc amps force unload
13,14,15	3		Ctf
16,17	2		Recycle delay (setpoint, not time left)
18	1		Aux 1 0=alarm, 1=shutdown
19	1		Aux 1 0=NO, 1=NC
20	1		Aux 2 0=alarm, 1=-shutdown
21	1		Aux 2 0=NO, 1=NC
22	1		Future
23,24	2		Future
25	1		Future
26	1		Future
27,28	2		Future
29	1		Future
30	1		ID (tenths position byte)
31	1		ID (ones position byte)
32	1		Checksum of all data (pos. 1 to 31)
33	1		CR code 13
34	1		LF code 10
35	1		0 null terminator char.

QUERY SETPOINTS DATA - #IDQ3 will return

Pos	#	Byte(s)	Setpoint (Name/Comment)
1,2,3,4	4		Setback setpoint
5,6,7,8	4		Future
9	1		Setback active 1=yes, 0=no
10,11,12,13	4		Autocycle comp. start
14,15,16,17	4		Autocycle comp. stop
18,19	2		Future
20,21	2		Future
22,23	2		Autocycle min. sv.
24	1		Autocycle active 1=yes, 0=no
25,26,27,28	4		Future
29,30,31,32	4		Future
33,34	2		Future
35,36	2		Future
37,38	2		Future
39	1		Future
40	1		ID (tenths position byte)
41	1		ID (ones position byte)
42	1		Checksum of all data (pos. 1 to 41)
43	1		CR code 13
44	1		LF code 10
45	1		0 null terminator char.

CHANGE SETPOINTS COMMAND: #01C

Start command sequence.
 01 Compressor ID code.
 C Change setpoint command.
 xxx New setpoint
 xx New setpoint
 y g or h for gauge or inches

The following is the complete list of the setpoints that may be changed while in the change setpoints command:

01xxx Capacity Control Setpoint
 ("y" deleted for KpaA & BarA ver.)
 02xxx Change Low Pressure Cutout Setpoint.
 ("y" deleted for KpaA & BarA ver.)
 03xxx Change Low Pressure Alarm Setpoint.
 ("y" deleted for KpaA & BarA ver.)
 04xxx Change High Pressure Cutout Setpoint.
 ("xxxx" is used for KpaA & BarA ver.)
 05xxx Change High Pressure Alarm Setpoint.
 ("xxxx" is used for KpaA & BarA ver.)
 06xxx Change MLC Stop Load Setpoint.
 07xxx Change MLC Force Unload Setpoint.
 08xx Change Recycle Delay Setpoint.
 09xxx Change CTF Setpoint.
 10xx Proportional Band (PB)
 11xx Dead Band (DB)
 12xx Cycle Time (CT)
 01 Compressor ID code.

PB 02, 05, 10, 15, 20, 25
 DB 05, 10, 15, 20, 25, 30, 35, 40, 45, 50,
 (decimal is assumed i.e. 01 = 0.1)
 CT 05, 10, 15, 20, 25, 30

RETURNED ANSWER:

Axxxx The new setpoint which was sent followed by a carriage return, line feed.
 "BAD" followed by the "ID", "CR", "LF" if unsuccessful.

If the command was sent #01C01300g01, the capacity control setpoint would be changed to 30.0g and the returned answer is A300g followed by a carriage return, line feed.
 If the command sent was #01C0711001, the MLC force unload setpoint would be changed to 110% and the returned answer is A110 followed by a carriage return, line feed.
 If the command sent was #01C0520002, the returned answer is "BAD" followed by the ID number and a carriage return, line feed.

g or h must be lower case - exception to "All commands must be caps" statement at beginning of section.

CHANGE COMPRESSOR MODE COMMAND:
#IDMCmID Change mode to m.
O=off A=autocycle R=remote
Return message - "A" followed by the "ID",
"CR", "LF" if successful.

CHANGE SLIDE VALVE MODE COMMAND:
#IDMvmID Change Slide Valve mode.
to m. A=auto R=remote
Return message - "A" followed by the "ID",
"CR", "LF" if successful.

CLEAR FAILURE COMMAND:
#IDKFID Clear Fails
Return message - "A" followed by the "ID",
"CR", "LF" if successful.

CLEAR ANTIRECYCLE COMMAND:
#IDKRID Clear Recycle Delay
Return message - "A" followed by the "ID",
"CR", "LF" if successful.

RETURN AC IO COMMAND:
#IDX Return Discrete AC IO Status Command:
Returns a 24 char data string followed by ID,
CR, LF. The 1st data
element represents input #1, the last element
represents output # 16.
1=energized or on, 0=deenergized or off.

RETURN FAILURE COMMAND:
#IDF Return Discrete Failure List Command:
Returns a 24 char data string followed by ID,
LF.
The 1st data element represents the 1st failure
on page 1 of the annunciator, the
last element represents the last failure on
annunciator page 4.
1=failed, 0=safe.
NOTE: not all pages or annunciator failure el-
ements are defined.

TEMPERATURE/PRESSURE CONTROL COMMUNICATIONS DATA

READ CONTROL TEMPERATURE COMMAND:
#JDTT Reads the control temp. from TE-5 (chan-
nel 5).
Returned Answer: +lll, CR, LF The + represents
the sign of the temperature.
The decimal is assumed between the third and
fourth character.

ADDITIONAL DISPLAY DUMP COMMAND:
#IDD1 Will dump SETPOINTS PAGE 1 (new display)
#IDDS Will dump ADJUSTABLE SETPOINTS (std
display)
#IDDC Will dump AUTO-CYCLE SETPOINTS (std
Pressure display)
#IDDT Will dump AUTO-CYCLE SETPOINTS (new
Temperature display)

CHANGE SETPOINTS COMMAND:
Start command sequence
ID Compressor ID code
C Change setpoint command
x numeric datum field
y g or h for gauge or inches datum field
+ + or- Sign datum field

Command Prefix #IDC##datumID
datum Description of setpoint
01xxxx Capacity Control
(“y” is deleted for KpaA & BarA ver.)
02xxxx Low Press. Cutout
(“y” is deleted for KpaA & BarA ver.)
03xxxx Low Press. Alarm
(“y” is deleted for KpaA & BarA ver.)
04xxx High Press. Cutout
(“xxxx” is used for KpaA & BarA ver.)
05xxx High Press. Alarm
(“xxxx” is used for KpaA & BarA ver.)
06xxx MLC Stop Load
07xxx MLC ForceUnload
08xx Recycle Delay
09xxx CTF
10xx Press. Proportional Band
11xx Press. Dead Band
12xx Press. Cycle Time
13+xxx Temp. Capacity Control
14+xxx Temp. Low Temp Cutout
15+xxx Temp. Low Temp Alarm
16xx Temp. Proportional Band
17xx Temp. Dead Band
18xx Temp. CycleTime
19x Pressure / Temperature mode. (x=1 for
temp. x=0 for pressure)
Ranges for PB, DB, CT pressure control
setpoints: (allowable entries)

PB 02, 05, 10, 15, 20, 25
DB 05, 10, 15, 20, 25, 30, 35, 40, 45, 50
(decimal is assumed eg. 01 = 0.1)
CT 05, 10, 15, 20, 25, 30

Ranges for PB, DB, CT temperature control
setpoints: (allowable entries)
PB 02, 05, 10, 15, 20, 25
DB 01 through 30 (decimal is assumed eg. 01
= 0.1)
CT 05, 10, 15, 20, 25, 30

RETURNED ANSWER:

Axxxx The new setpoint which was sent
followed by a carriage return,
line feed.
“BAD” followed by the “ID”, “CR”, “LF”
if unsuccessful.

Maintenance

TROUBLESHOOTING THE RWB II PLUS MICROPROCESSOR

This section contains information on troubleshooting and making corrections to the microprocessor and control circuits of the RWB II PLUS unit. The section is composed of four parts: a general information section, a troubleshooting guide, a repair procedure guide, and a section with illustrative schematics and data.

GENERAL INFORMATION

CAUTION THE COMPONENTS WITHIN THE MICROPROCESSOR CONSOLE CAN BE INADVERTENTLY DAMAGED BY STATIC ELECTRICITY OR MISHANDLING. ONLY QUALIFIED TECHNICIANS SHOULD DIRECTLY HANDLE THESE COMPONENTS.

1. DO NOT REMOVE the microprocessor console cover or attempt to make corrections to the microprocessor power supply without shutting off the control power. Accidental shorts can irreparably damage the SBC (single board computer) or the display screens.

2. DO NOT HANDLE the SBC or the display screen boards when their cables are disconnected without first attaching a ground strap to prevent static electrical discharge from your body.

Most problems encountered with the microprocessor and control circuits will be the result of a wiring fault, blown fuse, or failure of a peripheral control such as a solenoid coil or a pressure transducer. Faults in the computer, while possible, are unlikely. If a fault develops in the computer, the probability is that all functions will cease and the display screens will go blank.

The control system of the RWB II PLUS compressor consists of a 120 volt AC (high voltage) side and a 0-15 volt DC (low voltage) side. The 120 volt side actuates solenoids, relays, alarms, and other electromechanical functions. The 0-15 volt DC side operates the computer and its various sensors. The microprocessor console contains the SBC (single board computer) and two display screens.

WARNING When working within the microprocessor console, 120 VOLTS CAN CAUSE INJURY OR DEATH.

To troubleshoot the low voltage side of the RWB II PLUS control circuits, it is necessary to have the following tools:

1. Accurate digital multimeter.*
2. Small wire stripper.
3. Small screwdriver.
4. Small snip nose pliers.
5. 15 watt soldering iron (no larger).
6. .032,60/40 rosin core solder.
7. IC chip extraction and insertion tools.*
8. Grounding strap.*
9. Static free grounded work surface.

* Available from Frick. Order kit 451862.

TROUBLESHOOTING FRICK SBC MICROPROCESSOR SYSTEM (REFER TO WIRING DIAGRAMS)

SYMPTOM	PROBABLE CAUSES and CORRECTIONS
DISPLAYS ARE INOPERATIVE	<p>Check the 10 amp fuse (2FU) which controls all voltage going to the microprocessor.</p> <p>Shut off power to the microprocessor. Remove the console cover and confirm that all cable and wire connections are made.</p>
OIL PUMP DOES NOT START	<p>Verify that the Oil Pump HAND-OFF-AUTO switch (1SS) is in the AUTO position and that the Emergency Stop Button is not depressed.</p> <p>Output 11 controls the Oil Pump Starter Relay (3CR) when in the AUTO mode. If HAND is selected on 1SS, Output 11 will not have any effect on the operation of the oil pump starter.</p> <p>If AUTO has been selected and the oil pump does not start, check for 120VAC between Wires 39 and 2. If 120VAC is not found when the LED for Output 11 is on, check the fuse (FU11). If the problem persists, check the control relay (3CR).</p> <p>The Oil Pump Starter Auxiliary Contact switches voltage to Input 6 (Wires 28 and 2) when the auxiliary contacts are closed and the AUTO mode is selected on 1SS. If the Input does not turn on and voltage is present at Input 6, consult Frick Company.</p>

TROUBLESHOOTING FRICK SBC MICROPROCESSOR SYSTEM (Continued)

SYMPTOM	PROBABLE CAUSES and CORRECTIONS
<p>OIL PUMP IS RUNNING BUT THE COMPRESSOR DOES NOT START</p>	<p>The (HAND-OFF-AUTO) Oil Pump Selector Switch (1SS) controls oil pump operation and must be in the AUTO position before the compressor can be started.</p> <p>Verify that the Slide Valve has unloaded to 5% or less. If the Slide Valve has not unloaded, troubleshoot the hydraulic system. Compressor will not start until the Slide Valve is unloaded.</p> <p>Output 1 controls the motor starter. Check between terminals 38 and 2 for 120VAC. If 120VAC is not found when the LED for Output 1 is on, check the 1.5 amp fuse (FU1).</p>
<p>COMPRESSOR AUXILIARY SHUTDOWN</p>	<p>Output 1 controls the Compressor Start Relay (2CR). If the compressor does not start and the LED for Output 1 is on, check the fuse (FU1). If the problem persists, check the interposing relay (2CR).</p> <p>The Compressor Starter Auxiliary Contacts turn on Input 5 when they are closed. These contacts are located on the Compressor Starter.</p>
<p>OIL HEATERS DO NOT OPERATE</p>	<p>The oil heaters should operate only when the compressor is NOT running and the oil in the separator sump is cold.</p> <p>If the oil heaters do not work check fuse 1FU (15 amp). If the fuse is not blown, check between Wires 25 and 2 and between Wires 26 and 2 for 120VAC. If 120VAC is not found, check between wires 25 and 26. If 120VAC is found between wires 25 and 26, the Oil Heater Relay is defective. Next, check the voltage between Wires 9 and 2. If 120 VAC is present, the Oil Heater Relay is defective.</p> <p>If you do not read 120VAC between Wires 9 and 2 when the LED for output 10 is on, check the fuse (FU10).</p>
<p>SLIDE VALVE DOES NOT LOAD and/or UNLOAD</p>	<p>Verify that the Slide Valve is in the AUTO mode and that capacity control is calling for loading or unloading (AUTO L or AUTO U will appear on the Operating display).</p> <p>Output 2 controls the Slide Valve Load Solenoid. If 120VAC is found across Wires 17 and 2, the Slide Valve Load Solenoid should be energized. If not, the solenoid is defective. If 120VAC is not found when the LED for Output 2 is on, check the fuse (FU2).</p> <p>Output 3 controls the Slide Valve Unload Solenoid. If 120VAC is found across Wires 16 and 2, the Slide Valve Unload Solenoid should be energized. If not, the solenoid is defective. If 120VAC is not found across Wires 16 and 2 when the LED for Output 3 is on, check the fuse (FU3).</p> <p>NOTE: Verify that the proper setpoint has been programmed into C.C. (Capacity Control) on the Adjustable Setpoints display.</p>
<p>SLIDE STOP DOES NOT INCREASE and/or DECREASE</p>	<p>Verify that the Slide Stop is in the AUTO mode and that the Vi Ratio is calling for a Vi increase or a Vi decrease (AUTO I or AUTO D will appear on the Operating display).</p> <p>Output 4 controls the Slide Stop Increase Solenoid. If 120VAC is found across Wires 15 and 2, the Slide Stop Increase Solenoid should be energized. If not, the solenoid is defective. If 120VAC is not found across Wires 15 and 2 when the LED for Output 4 is on, check the fuse (FU4).</p> <p>Output 5 controls the Slide Stop Decrease Solenoid. If 120VAC is found across Wires 14 and 2, the Slide Stop Decrease Solenoid should be energized. If not, the solenoid is defective. If 120VAC is not found across Wires 14 and 2 when the LED for Output 5 is on, check the fuse (FU5).</p>



TROUBLESHOOTING FRICK SBC MICROPROCESSOR SYSTEM (Continued)

SYMPTOM	PROBABLE CAUSES and CORRECTIONS
LIQUID INJECTION SOLENOID DOES NOT ENERGIZE (LIQUID INJECTION REFRIGERANT CUTOUT - LICO)	Verify that the Liquid Injection TXV is modulating properly and not feeding excessive liquid to the compressor. When oil temperature drops too low, the microprocessor SHOULD de-energize this solenoid. Output 6 controls the Liquid Injection Solenoid. If 120VAC is found across Wires 13 and 2, the Liquid Injection Solenoid should be energized. If not, the solenoid is defective. If 120VAC is not found when the LED for Output 6 is on, check the fuse (FU6).
HI VI LIQUID INJECTION PORT (OPTIONAL) SOLENOID DOES NOT ENERGIZE	Output 7 controls the Hi Vi Liquid Injection Port solenoid. If 120VAC is found across Wires 12 and 2, the Hi Vi Liquid Injection Port Solenoid should be energized. If not, the solenoid is defective. If 120VAC is not found when the LED for output 7 is on, check the fuse (FU7). NOTE: This output should only be on when the Vi is above 3.4
ECONOMIZER (OPTIONAL) SOLENOID DOES NOT ENERGIZE	Output 8 controls the Economizer Solenoid Valve. If 120VAC is found across Wires 11 and 2, the Economizer Solenoid should be energized. If not, the solenoid is defective. If 120VAC is not found when the LED for Output 8 is on, check the fuse (FU8). NOTE: The economizer output should only be on when the slide valve is at or above the 90% position.
ALARM HORN DOES NOT ENERGIZE	Output 9 controls the Alarm Horn. The Alarm should turn on only when there is a prealarm. If the Alarm does not sound when these conditions are found, check for 120VAC across Wires 10 and 2. If 120VAC is not found, check the fuse (FU9).
CONTROL PANEL DOES NOT RESPOND TO REMOTE CONTROL SIGNALS	Inputs 2 through 4 can be used to operate the compressor from a remote location. NOTE: Check the Operating display to verify that the compressor and the slide valve are in the REMOTE MODE. If 120VAC is found (across Wires 21 and 2, 22 and 2, and 23 and 2) and the input does not turn on, consult Frick Company.
MOTOR LOAD CONTROL (FORCED UNLOAD) OCCURS AT LOW MOTOR AMPS	The current transducer is used to convert the AC motor amps to a DC voltage signal for the microprocessor. If the %FLA reading from the Operating display is incorrect, consult Frick.
PRESSURES ON THE OPERATING DISPLAY DO NOT APPEAR CORRECT	TEST 1 - Shut down the compressor and allow pressures to equalize. Suction pressure, discharge pressure, and oil pressure should have the same reading. TEST 2 - If either oil pressure or discharge pressure read different pressures, one or both transducers are at fault. Valve off the suction transducer from the unit and open the vent valve on transducer manifold to atmosphere. If the suction transducer reads atmospheric pressure, then the high pressure transducer which agreed with the suction transducer in Test 1 is correct. The transducer which disagreed is defective. NOTE: A 1% tolerance is allowed for all transducers.
COMPRESSOR DOES NOT AUTOMATICALLY LOAD OR UNLOAD	Verify that the [AUTO] key has been pressed and AUTO appears under SV Pos on the Operating display. If the problem persists, see the Troubleshooting section SLIDE VALVE DOES NOT LOAD and/or UNLOAD.
DISPLAY SCREENS DISPLAY SCRAMBLED PATTERN OR LISTS ALPHABET	A loose or improper connection between the displays and the SBC is indicated. Remove fuse (2FU, 10 amp) for 15 seconds and, then, restore to reset the displays.

Testing Micro-Panel Alarms / Cutouts



The following are testing procedures that may be used as a means of testing the standard safeties provided on the RWB II Frick Rotary Screw Compressor Unit with a RWB II Plus microprocessor. They should only be completed by a competent individual with full understanding of safe operating procedures as they apply to industrial refrigeration. If there are any questions in regard to any one of these procedures, do not attempt prior to consulting Frick at (717) 762-2121.

High Discharge Press. Alarm / Cutout

1. Once the machine is up and running and maintaining an even discharge pressure, go to the adjustable setpoints display (record the values for the **Hi Disch Alarm and Cutout**).
2. Step down to the **Hi Disch Alarm** setpoint and enter a value of 10 psig lower than the current running Discharge Pressure.
3. Then go back to the operating display to check for an alarm. If no alarm exists, ensure that the current discharge pressure is indeed above the new alarm value.
4. If you do have an alarm, go to **Hi Disch Cutout** and reset the value to 5 psig below the current running pressure.
5. You should instantly receive the cutout. If the cutout was not received, ensure that the value is still lower than the running pressure.
6. If a cutout was received return to the adjustable setpoints screen and reenter the original alarm and cutout value. Clear the alarm and cutout.
7. Allow the recycle delay to elapse and proceed to the next test.

Low Suction Press. Alarm / Cutout

1. With the machine running and maintaining an even suction pressure, go to the adjustable setpoints screen (record the values for the **Lo Suct Alarm and Cutout**).
2. Step to the **Lo Suct Alarm** and enter a value 3 psig or 3 in. hg higher than the current running pressure.
3. Return to the operating display and check for an alarm. If no alarm exists check to ensure that the current running suction pressure is indeed lower than the new alarm value.
4. If an alarm was received, go to the **Lo Suct Cutout** and set the value 5 psig or 5 in. hg higher than the current running pressure.
5. Once the cutout occurs, go back and reset to the original values, and clear the cutout and alarm. Allow the recycle delay to elapse and proceed.

Note: The Lo Suct Cutout has a 90 second delay.

Oil Pressure Alarm / Cutout

1. Push the +/- button and record the **Oil Pressure** value from the analog offset display (Example: +2).
2. With the machine running and maintaining good, even oil pressure, push the [+/-] button to access the analog offset screen.
3. Step to the oil pressure value and max it out to +9. This must be done to avoid a sensor fault failure.
4. At the transducer manifold, close the valve for the oil pressure transducer (PE-1) and then open the vent valve which exposes the transducer to atmosphere.
5. Once the time delays have expired (30 seconds for the alarm and an additional 10 seconds for the cutout), an alarm and cutout will occur.

6. Place valves back into their operating position and replace the pipe plug in the vent.
7. Return to the analog offset screen and reset the offset back to the original value.
8. Clear the alarm and cutout. Allow the recycle delay to elapse, then proceed to the next test.

Hi Oil Temp Alarm / Cutout

1. Record the values for **Hi Oil Temp Alarm** and **Cutout** stated on the fixed setpoints display.
2. Carefully remove temperature probe TE-3, located downstream from the oil filter.
3. Slowly apply heat to the probe with a forced-air device such as a heat gun or blower dryer.
4. Once the temperature rises to the alarm value stated on the fixed setpoints display, an alarm should be received with no delay.
5. Allow the temperature to continue rising until the cutout temperature is met and the cutout is received with no delay. Allow probe to cool then reinstall in the well.
6. Allow the recycle delay to elapse and proceed with the next test.

Lo Oil Temp Alarm / Cutout

1. Record the values for **Lo Oil Temp Alarm** and **Cutout** from the fixed setpoints display.
2. Carefully remove TE-4 from the belly of the separator and immerse the probe into a crushed ice water bath.
3. Once the temperature drops to the alarm value the alarm will be received without delay. Allow the temperature to continue falling until the cutout value is met and occurs without delay. Reinstall TE-4.
4. Clear the alarm and cutout. Allow the recycle delay to elapse and proceed to the next test.

Hi Disch Temp Alarm / Cutout

1. Record the **Hi Disch Temp Alarm** and **Cutout** values from the fixed setpoints display.
2. With the machine running, remove the discharge temperature probe TE-2 located on the discharge pipe between the compressor and the separator.
3. Using a forced-air heat source, such as a heat gun or blow dryer, slowly add heat to the probe and monitor the operating display until the temperature exceeds the alarm value and the alarm sounds.
4. Continue adding heat until the cutout value is met and exceeded. The cutout should be received without delay. Reinstall TE-2.
5. Clear the alarm and cutout. Allow the recycle delay to elapse and proceed to the next test.



Never expose the probe to a direct open flame during test. Rapid temperature rise could cause the probe to stick or short in the closed position which would require the probe to be changed.

Comp. Auxiliary

1. Remove #20 wire from terminal strip P3 and place a wire nut over the end.
2. Push the **RUN** button.
3. If the input #5 does not receive a signal from the Compressor Auxiliary Contact, the machine will cut out 16 seconds after 2CR is energized.
4. Replace the #20 wire.
5. Clear the Cutout.
6. Allow the recycle delay to elapse and proceed to the next test.

Pump Auxiliary

1. Remove #19 wire from terminal strip P3 and place a wire nut over the end.
2. Push the **RUN** button.
3. If input #6 does not receive a signal after 2 1/2 seconds from the time 3CR was energized, a cutout will occur.
4. Replace the #19 wire.
5. Clear the cutout and proceed to the next test.

Oil Level

1. Remove wire #24 from terminal strip P3 and place a wire nut over it.
2. Push the **RUN** button.
3. If input #1 does not receive a signal within 5 minutes, a cutout will occur.
4. Replace wire #24.
5. Clear the cutout.
6. Allow the recycle delay to elapse and proceed to the next test.

NOTE: The oil level cutout is not present on units with full lube pumps. If you are unsure of the pump type on your unit, contact Frick Service for confirmation.

Dirty Filter

1. Push the **[+/-]** key and record the **Oil Pressure** value from the analog offset display (Example: +2).
2. With the machine running and maintaining good pressures and temperatures, push the +/- button to access the analog offset screen. Step to the oil pressure value and max it out to +9. This must be done to avoid a sensor fault cutout.
3. At the transducer manifold, close the valve for transducer PE- 1 and open the bleed valve for that transducer to atmosphere which will bring the pressure down to 0 psig.
4. In about 15 seconds, a dirty filter alarm will occur.
5. Quickly close the bleed valve and open the valve to PE-1 to avoid an oil pressure alarm/cutout.
6. Clear the alarm.
7. If cutout occurs, ensure that the valves are in their operating position, and the plug has been put back into the vent.
8. Return to the analog offset screen and reset the offset back to the original value.
9. Allow for the recycle delay to elapse and restart the machine.

EPROM MEMORY I/C CHIP REPLACEMENT

Microprocessor EPROM memory I/C chips are located inside the microprocessor console on the SBC board. A special tool is required to remove these chips to lessen the chance of damaging them (See Troubleshooting The Microprocessor). The procedure to replace EPROM memory chips is outlined below:

1. Shut off control power.
2. Remove the microprocessor console cover.
3. Using a chip extraction tool, remove the old EPROM chips from the SBC board. Pay particular attention to the orientation of the notch on the end of the chip; then install new chip with the notch in the same position. **NOTE: The chip labeled 4 must be inserted into socket U4 and the chip labeled 5 must be inserted into socket U5.**

SBC BOARD REPLACEMENT

The procedure to replace SBC boards is outlined below:

1. Shut off control power.
2. Remove the old board from the machine and the new board from its packing and place both on an antistatic surface.
3. Remove the program chip(s) from the defective board and install them in the replacement board.



CAUTION Pay particular attention to the orientation of the notch(es) on the end of the chip(s). Install the chip(s) on the replacement board in exactly the same position as they were on the defective board.

4. **IMPORTANT:** Before installing the new board, determine if there are gray/yellow wires from P15 (see the SBC wiring diagram for location) on the old board. If they are present, the display is the old style and the new board can be installed without modification.

5. If the gray/yellow wires are not present on the old SBC, the machine is equipped with a new style display. Resistor R6 must be removed from the new board by cutting the wire leads on either side of the resistor.

6. Then install the modified replacement board in the panel.

MICROPROCESSOR DISPLAY REPLACEMENT

The procedure to replace the microprocessor display is outlined below:

1. Shut off control power.
2. Remove the defective display(s).
3. Install the new display(s).
4. If present, remove the grey/yellow wires from P15 (see the SBC wiring diagram for location) to the display(s) as they are no longer needed.
5. If resistor R6 is present on the SBC, cut off the wire leads on both sides (see the SBC wiring diagram for location) and remove it. This resistor is no longer needed.

OUTPUT FUSE REPLACEMENT

1. Shut off control power.
2. Remove the microprocessor console cover.
3. Identify the faulty fuse.
4. Use a voltmeter to verify that no voltage is present on either side of the fuse.
5. Remove the faulty fuse using a fuse puller or screwdriver.
6. Install a new plug-type fuse.

SBC WIRING DIAGRAM

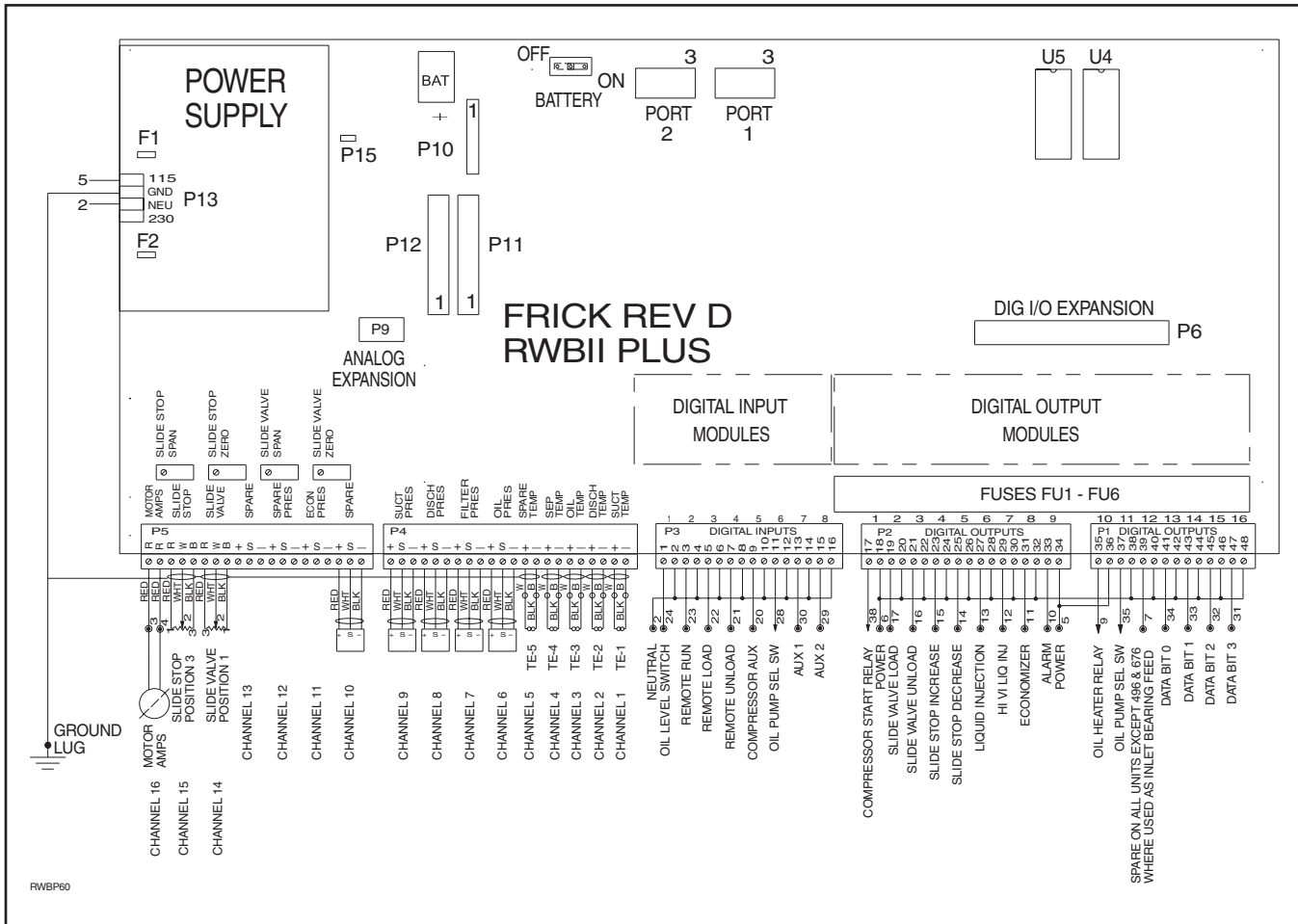

POINT-TO-POINT FIELD WIRING DIAGRAM

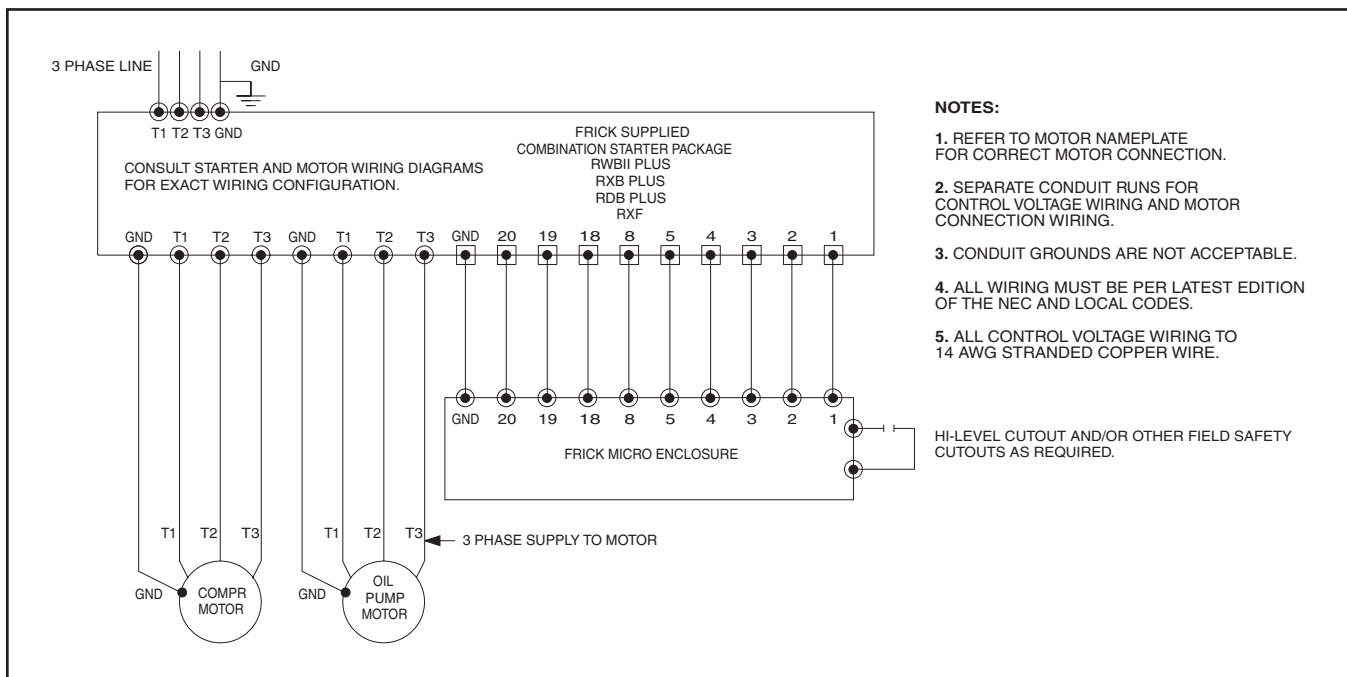

MICRO COMPONENT PLACEMENT DIAGRAM

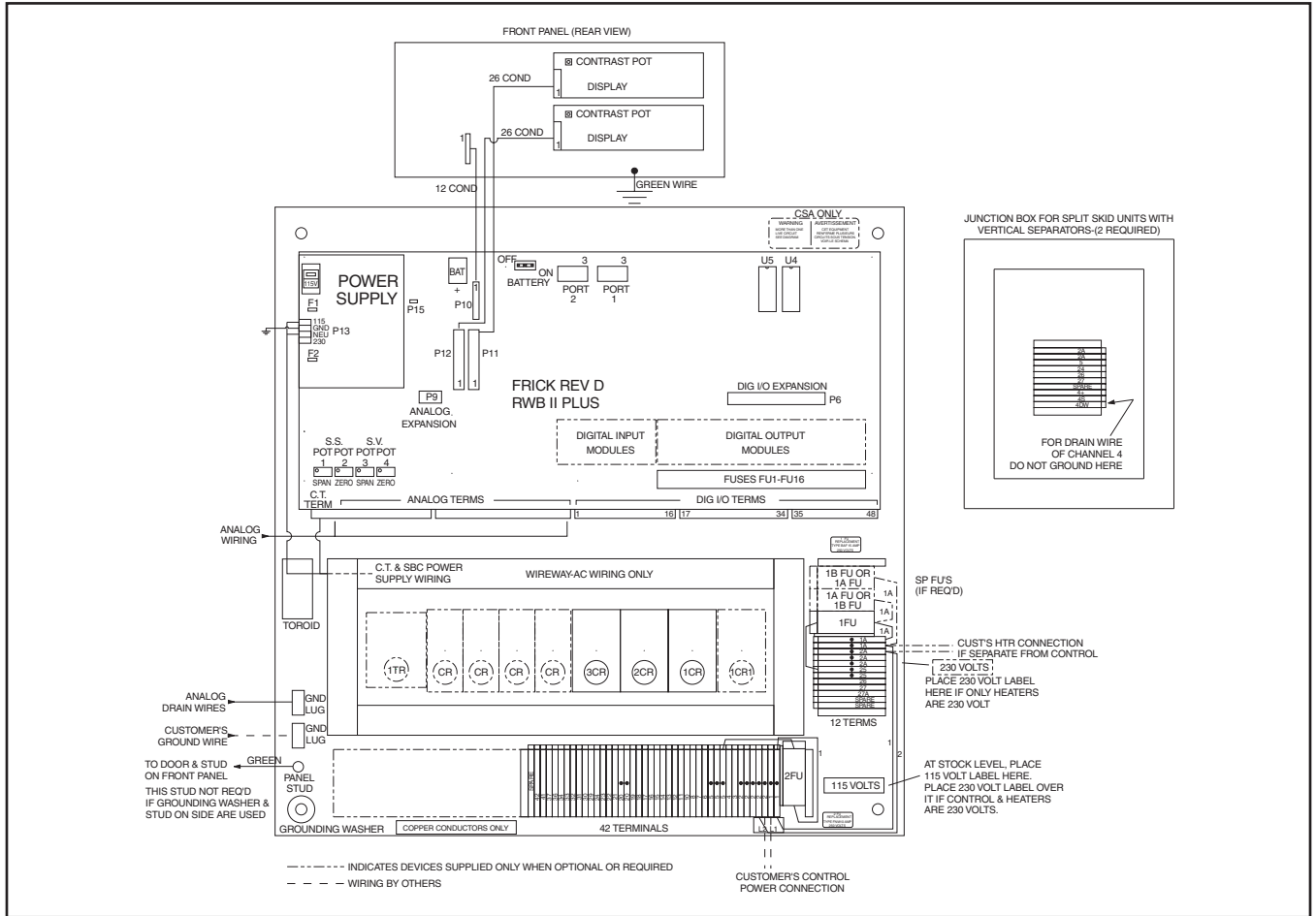

RWB II PLUS TELECOMMUNICATIONS

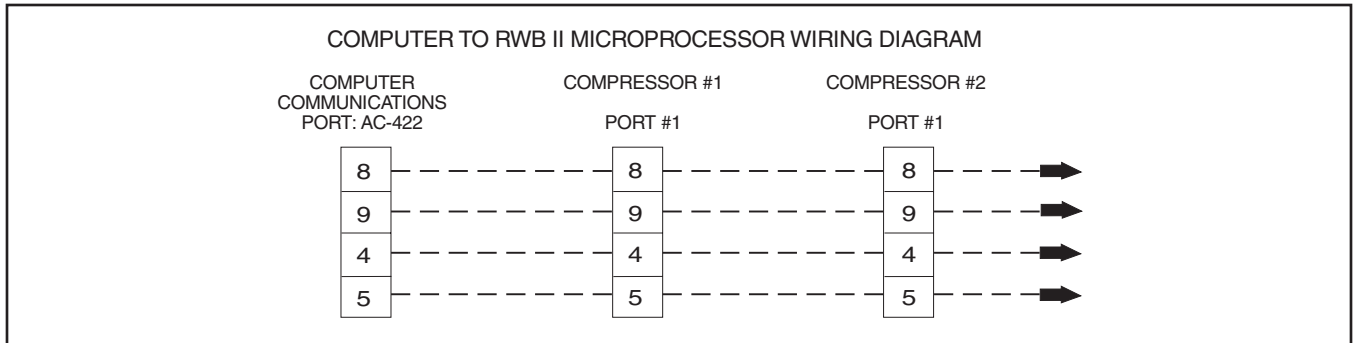

AC-422 Asynchronous Adapter Card Pinout

- 1,3 Ground
- 9 - RX (Receive)
- 8 + RX (Receive)
- 5 - TX (Transmit)
- 4 + TX (Transmit)

RS-422 Communication Ports 1 and 2

- Word = 8 bit
- Parity = None or Even
- Stop = 1 Bit

RWB II PLUS MICRO Ports 1 and 2 Pinout

- 3 Ground
 - 2 - CTS (Clear To Send)
 - 1 + CTS (Clear To Send)
 - 5 - RX (Receive)
 - 4 + RX (Receive)
 - 7 - RTS (Request To Send)
 - 6 + RTS (Request To Send)
 - 9 - TX (Transmit)
 - 8 + TX (Transmit)
- NOTE: Jumper Pin 1 to 6 and Jumper Pin 2 to 7
If RTS is "+", CTS are not used.

MICROPANEL ASSEMBLY WIRING DIAGRAM

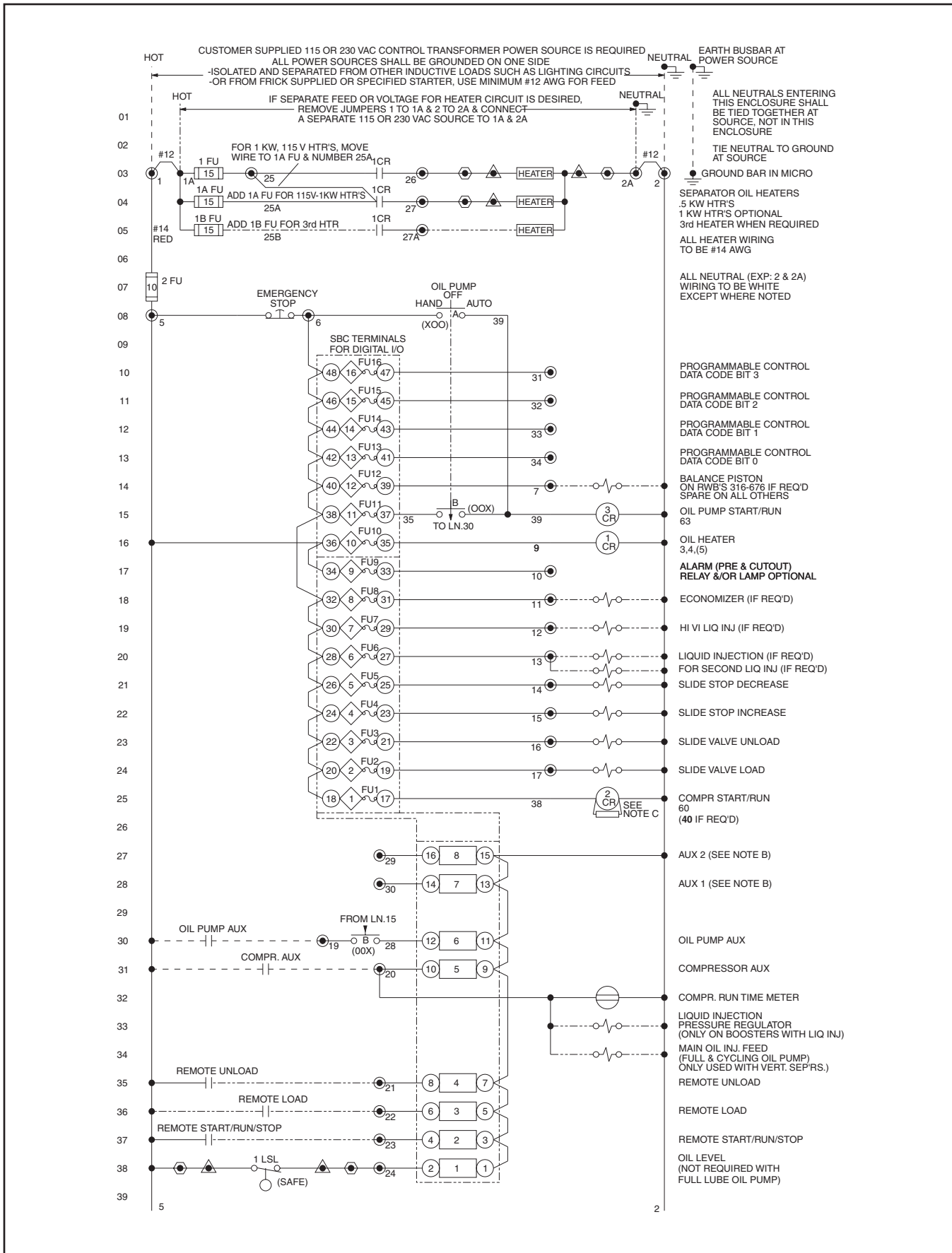

MICROPANEL ASSEMBLY WIRING DIAGRAM

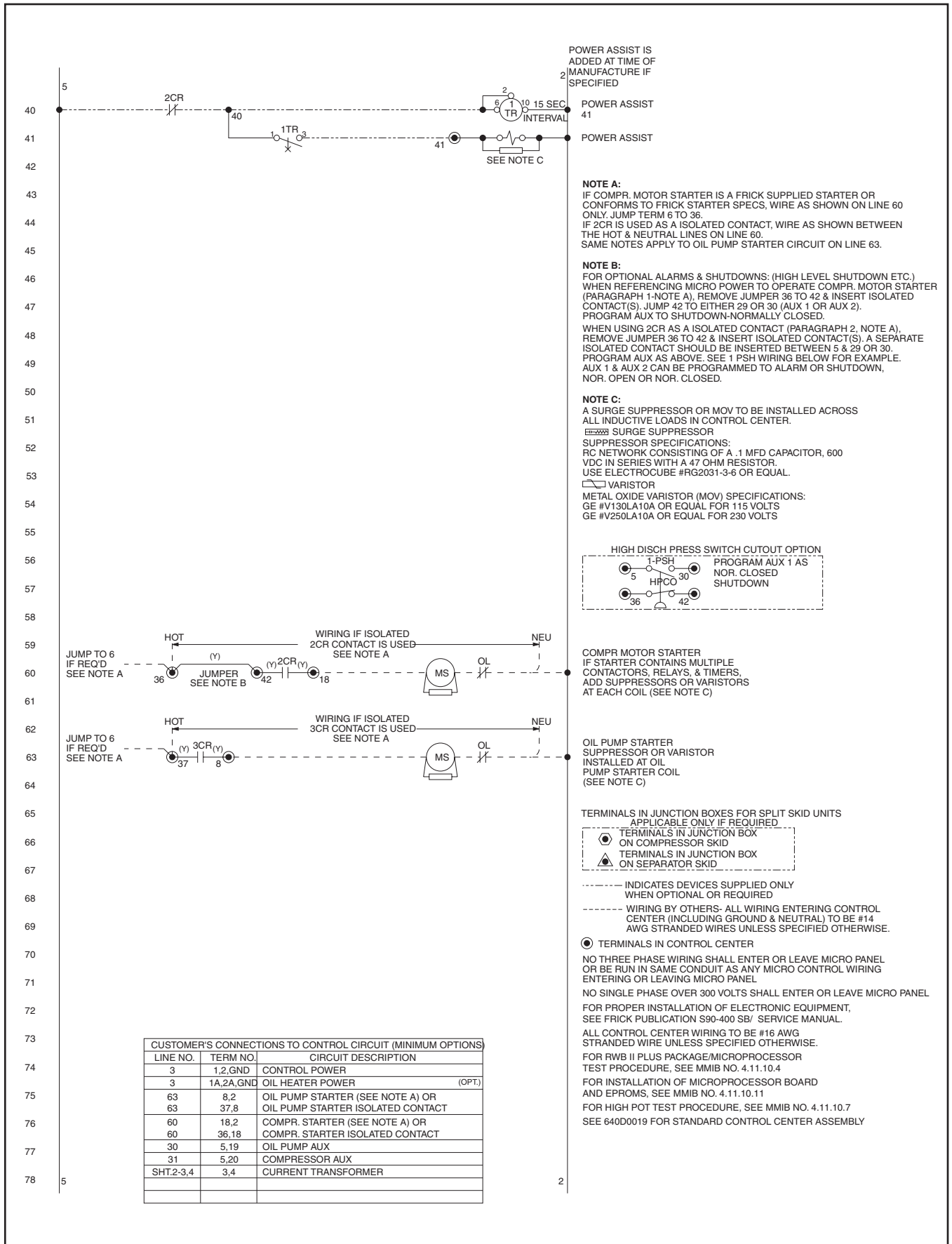

CUSTOMER'S CONNECTIONS TO CONTROL CIRCUIT (MINIMUM OPTIONS)

LINE NO.	TERM NO.	CIRCUIT DESCRIPTION
3	1,2,GND	CONTROL POWER
3	1A,2A,GND	OIL HEATER POWER (OPT)
63	8,2	OIL PUMP STARTER (SEE NOTE A) OR OIL PUMP STARTER ISOLATED CONTACT
63	37,8	OIL PUMP STARTER ISOLATED CONTACT
60	18,2	COMPR. STARTER (SEE NOTE A) OR COMPR. STARTER ISOLATED CONTACT
60	36,18	COMPR. STARTER ISOLATED CONTACT
30	5,19	OIL PUMP AUX
31	5,20	COMPRESSOR AUX
SHT.2-3,4	3,4	CURRENT TRANSFORMER

MICROPANEL ASSEMBLY WIRING DIAGRAM

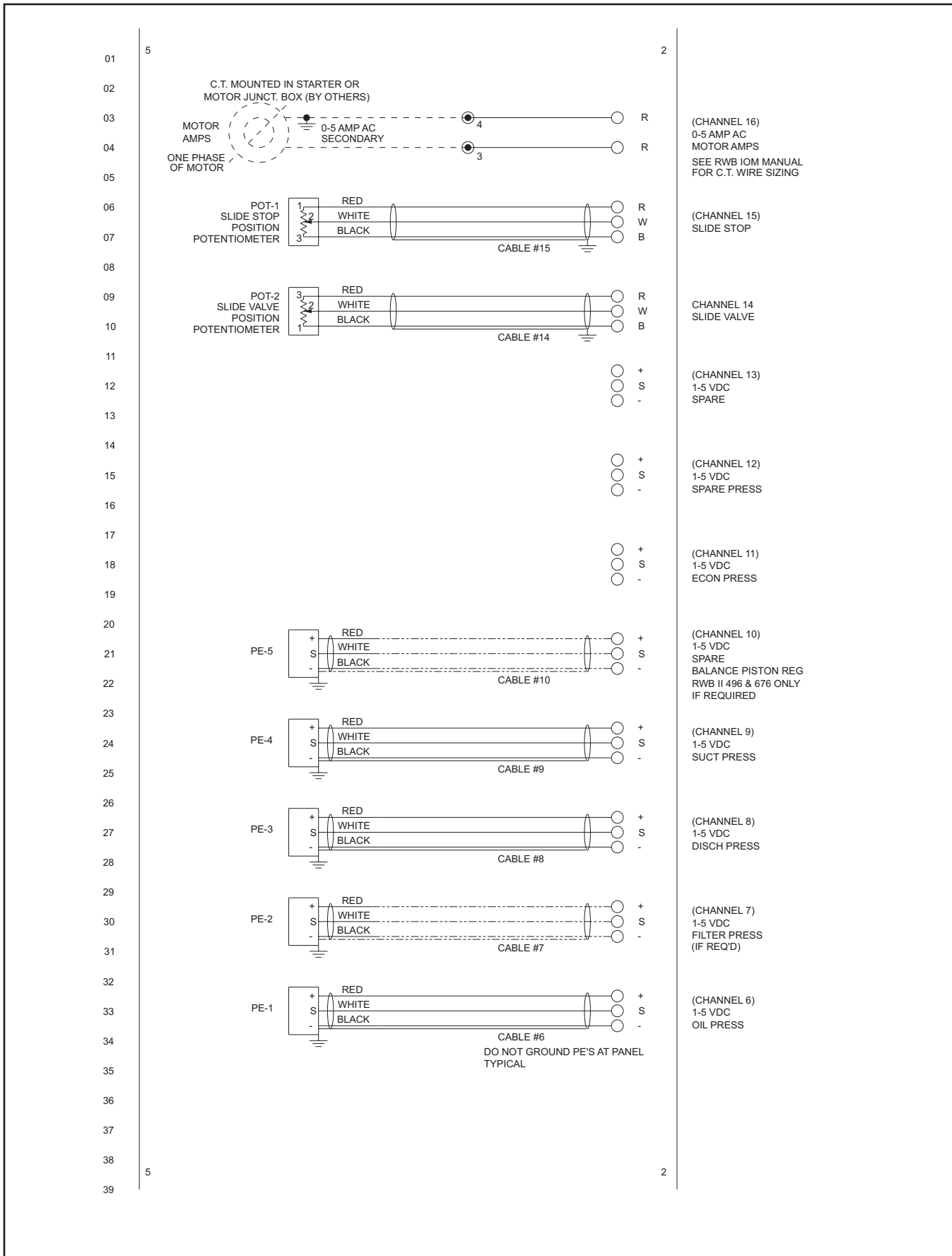

MICROPANEL ASSEMBLY WIRING DIAGRAM

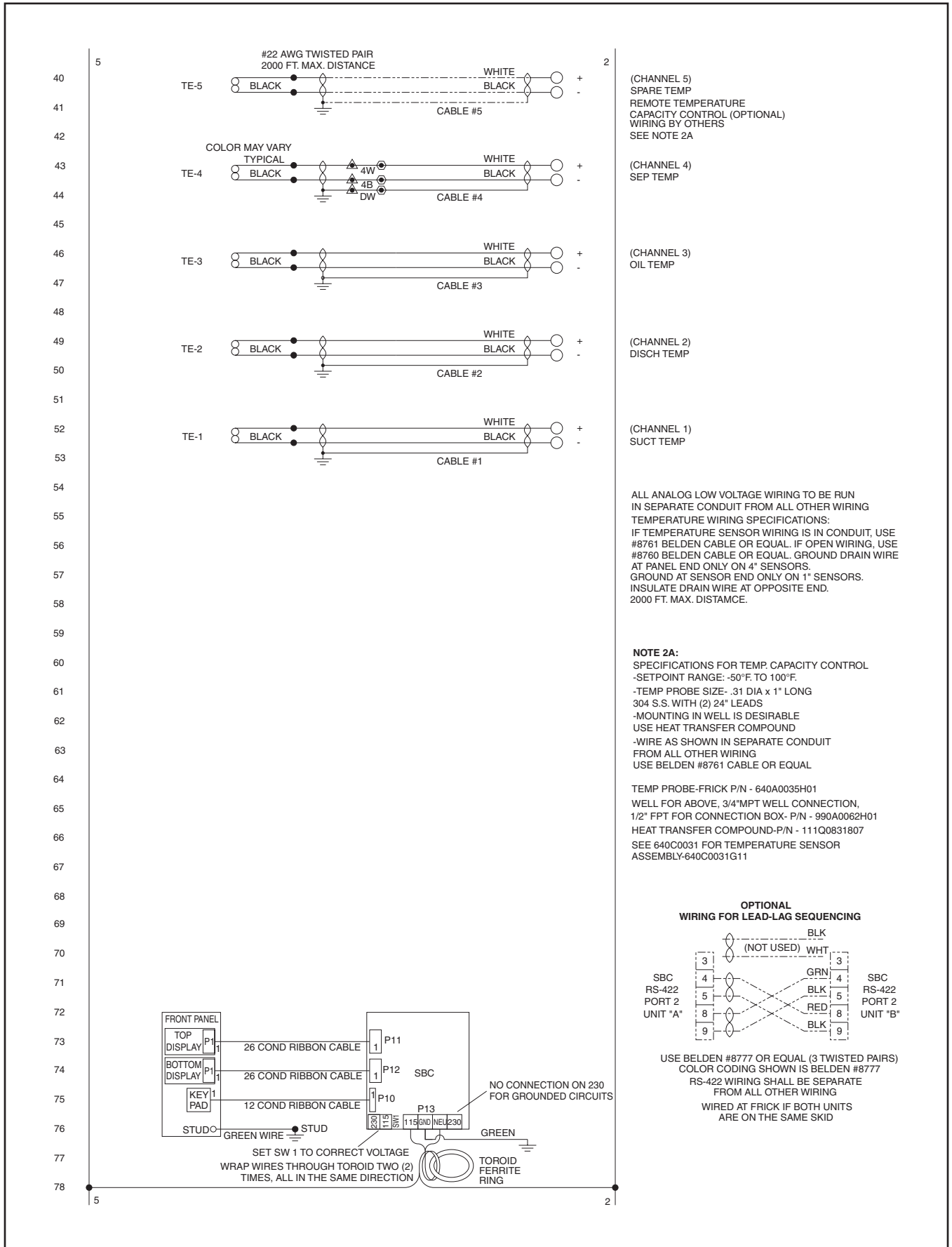

Q-NET™ network technology...

Make the Connection with QUANTUM™!

Take full advantage of Q-NET™ technology with all Frick® products!

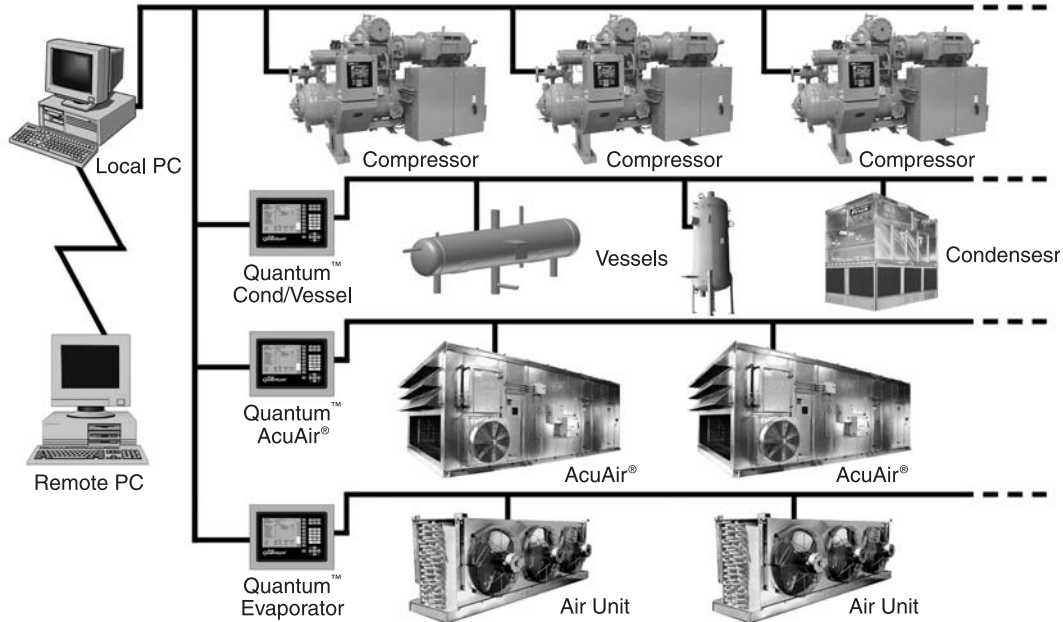

System integration is what we do...

- Q-NET™ ... supports open-protocols for your SCADA system (i.e. Allen Bradley DF1 and Modbus ASCII)
- Q-NET™ ... connects for local or remote access
- Q-NET™ ... can be applied to both new and existing systems

Q-NET™ means precise control 24 hours a day, seven days a week

Q-NET™ distributed architecture means faster, easier, economical installations

Q-NET™ delivers increased operating efficiency and lowers energy costs

Now available on Frick's AcuAir® hygienic air handlers, condensers, screw compressors, evaporators, and refrigerant vessels, too.

Take Control.™