

CORNELL PUMP COMPANY

Industrial Pumps

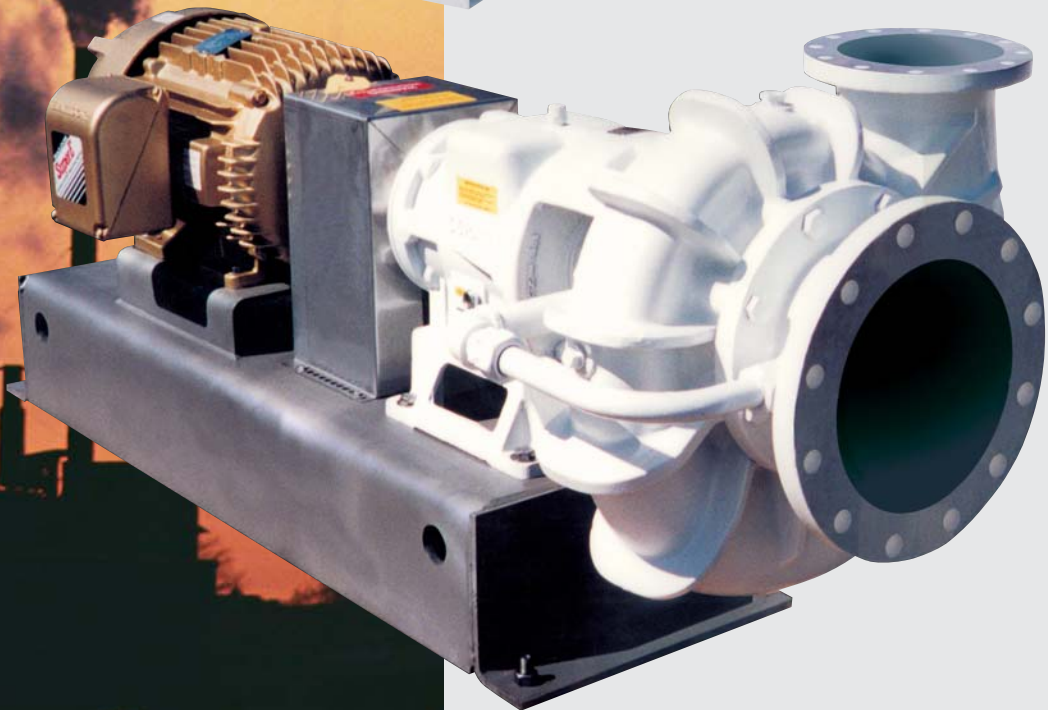
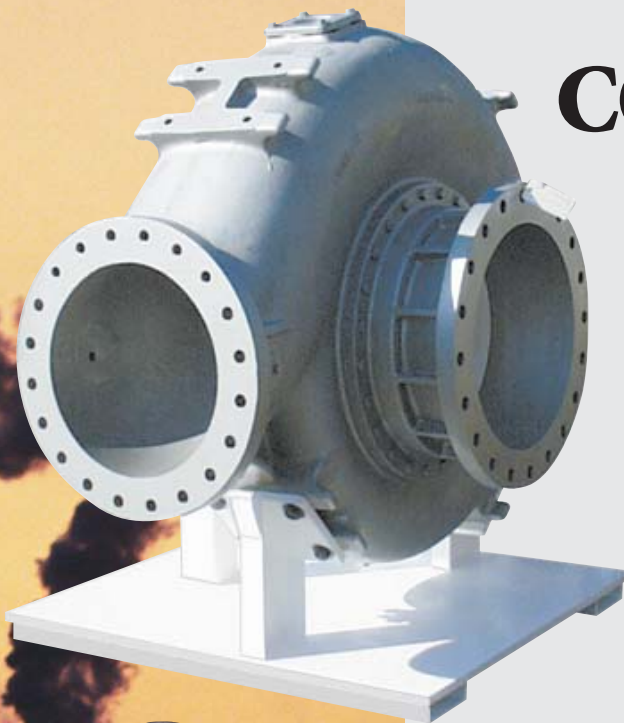

INDUSTRIAL WASTE

Impellers

Cornell's two- and three-port enclosed, non-clog impellers are designed to handle large solids and maintain exceptional hydraulic efficiencies. Cornell's Delta™-style impeller is specifically designed for handling stringy materials and heavy sludge for low- to medium-head applications and our three- or four-vane, semi-open impeller generates a cutting action designed to handle concentrated slurries for high head applications.



SOLIDS HANDLING PUMPS

Cornell Solids Handling Pumps are used for waste water, sludge, stringy material, de-watering, abrasive transfer, canneries, construction, dredging, lumber mills, slush ice, reclamation plants and foundry or mill slag.

Available with Delta™, Semi-open, Enclosed, and Chopper impellers, Cornell pumps are offered in various discharge sizes ranging from 3 to 30 inches, with heads to 470 feet TDH, and flow rates of up to 38,000 GPM.

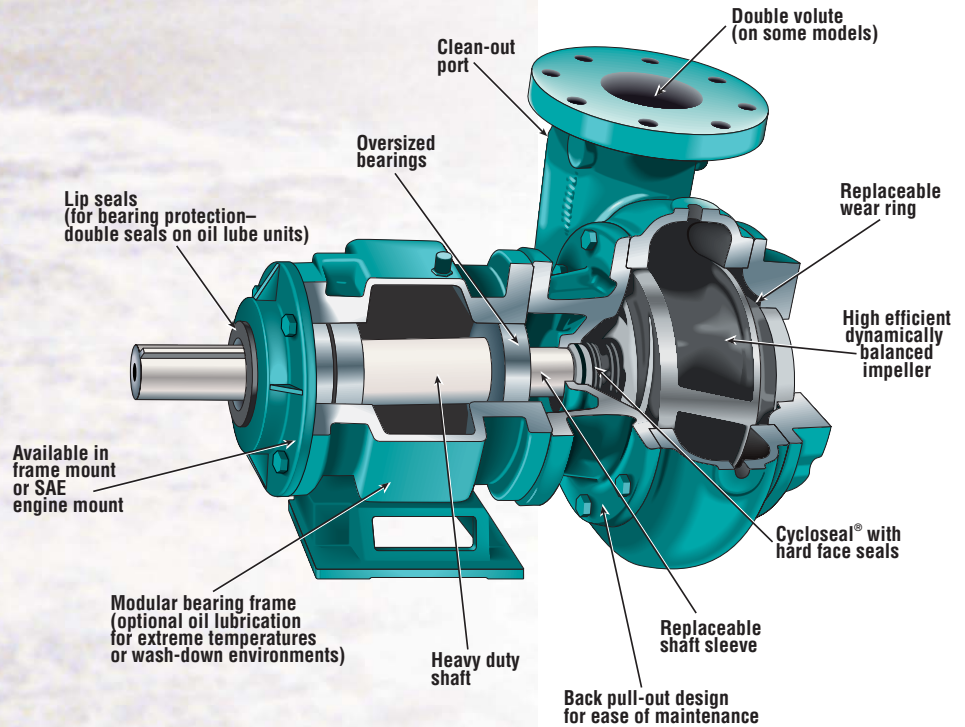

Solids Handling Pumps, Enclosed Impeller

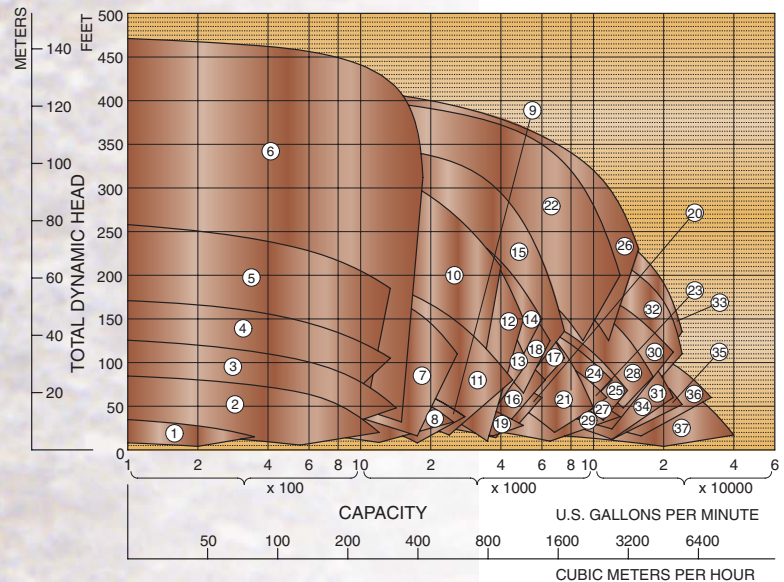

1. 3NLT	8. 6NNT	15. 8NHGA	22. 12NHG28	28. 16NHG22	33. 18NHG34
2. 4NNTL	9. 6NHT/TH	16. 10NHTB	23. 14NHG	29. 16NHG32	34. 20NHFL
3. 4NNT	10. 6NHTB	17. 10NHTBH	24. 14NHGA	30. 18NHG	35. 20NHF
4. 4NHTA	11. 8NNT	18. 10NHTA	25. 14NHGH	31. 18NHFL	36. 24NNG
5. 4414T	12. 8NHTA	19. 12NHTL	26. 14NHG28	32. 18NHF34	37. 30NNT
6. 4NHTB	13. 8NHHT	20. 12NHTM	27. 16NHGH		
7. 6NHTA	14. 8NHTR	21. 12NNF			



Chopper Pumps

With its heavy duty, ASTM A536 grade 65-45-12 ductile iron construction, using our patented Cycloseal® design (patent #5489187), the Cornell Chopper pump is ideally suited for chopping solids. The replaceable cutter bar is made of T1 tool steel, heat treated to a minimum 60 Rockwell C hardness. Heat treated impellers of cast alloy steel, AISI 8630, and 416 stainless steel shaft sleeves are standard. The bearing frame is fitted with heavy-duty back-to-back angular contact ball bearings to handle



SUBMERSIBLES

Cornell uses the same high efficiency pump-ends for our submersibles that have been proven time and again in standard municipal applications. Coupled with the highest quality motors, Cornell's submersible product line provides the best possible value.

Chopper Pump Curves

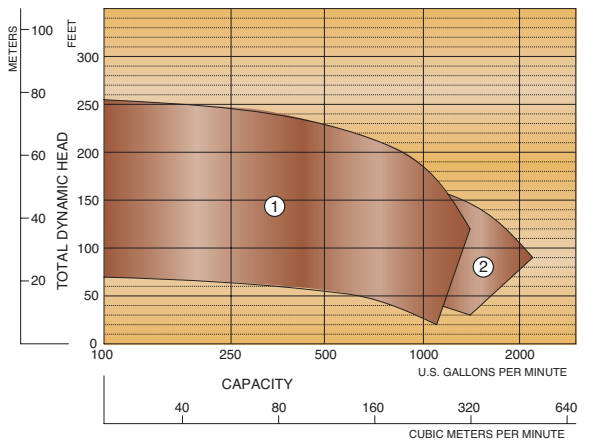

1. 4NC
2. 6NC

axial loads and provide exceptional bearing life. Our Chopper pumps are fitted with a John Crane type 2 tungsten carbide mechanical seal as standard with an optional Run-Dry™ seal system available. TDH ranges from 30-200 feet with flows ranging from 0-1500 GPM.

Delta™ Style Pumps

Cornell's Delta™ impeller vanes extend continuously across the pump's suction entrance and their trailing edges reduce low pressure areas.

Solids Handling Pumps, Delta™ Impeller

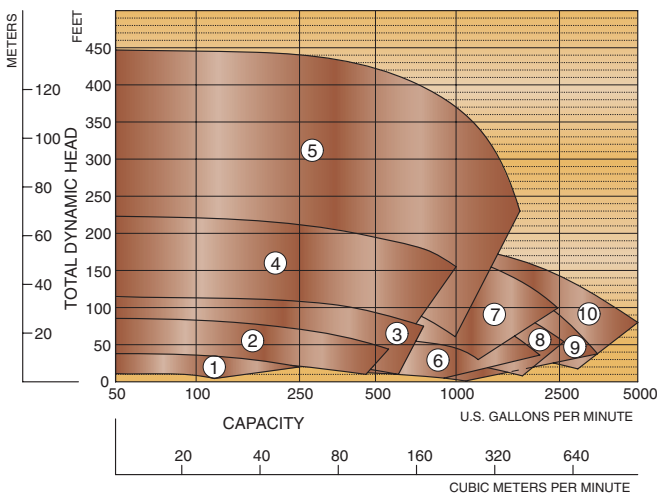

- | | | |
|----------|----------|------------|
| 1. 3NLA | 5. 4NHM | 9. 8NNDH |
| 2. 4NLDL | 6. 6NHDH | 10. 10NNDH |
| 3. 4NNDH | 7. 6NHM | |
| 4. 4NHDH | 8. 6NNDH | |

Two distinct vortices are created which pass solids through the impeller. The absence of sharp impeller edges prevents "hair pinning" or hang-up of stringy materials. Larger solids are effectively broken up by the comminuting action of the impeller vanes. Many of our enclosed impeller type pumps can be retrofitted with Delta™ style impellers.

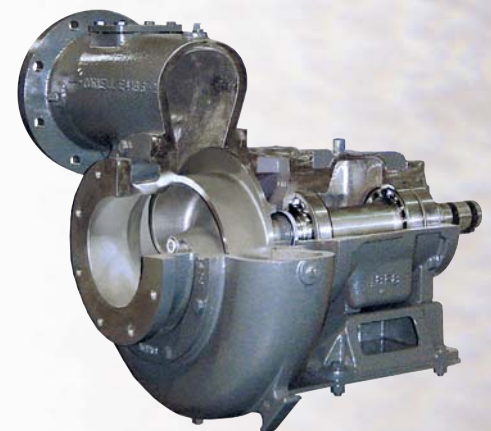

DELTA™

Pump Sizes:

3" x 3", 4" x 4", 6" x 6",
8" x 8", and 10" x 10"

Capacities:

50 GPM to 5,000 GPM

Heads:

10 Feet to 450 Feet

INDUSTRIAL PROCESS



CLEAR LIQUID PUMPS

Cornell Clear Liquid Pumps are used for commercial and residential irrigation, golf course and lawn maintenance, aqua culture, fountains, breweries, laundries cooling towers, fire fighting, reverse osmosis feed, and water boosters.

The W, Y, R and H series pumps are available in a wide range of materials with discharge sizes ranging from 1 to 10 inches, heads to 450 feet TDH, and flow rates up to 7,000 GPM.

Cornell offers a comprehensive line of standard and special purpose industrial process centrifugal pumps including 1" to 42" discharge diameters. We offer premium quality centrifugal pumps that incorporate highly engineered features specifically designed to enhance performance and longevity.

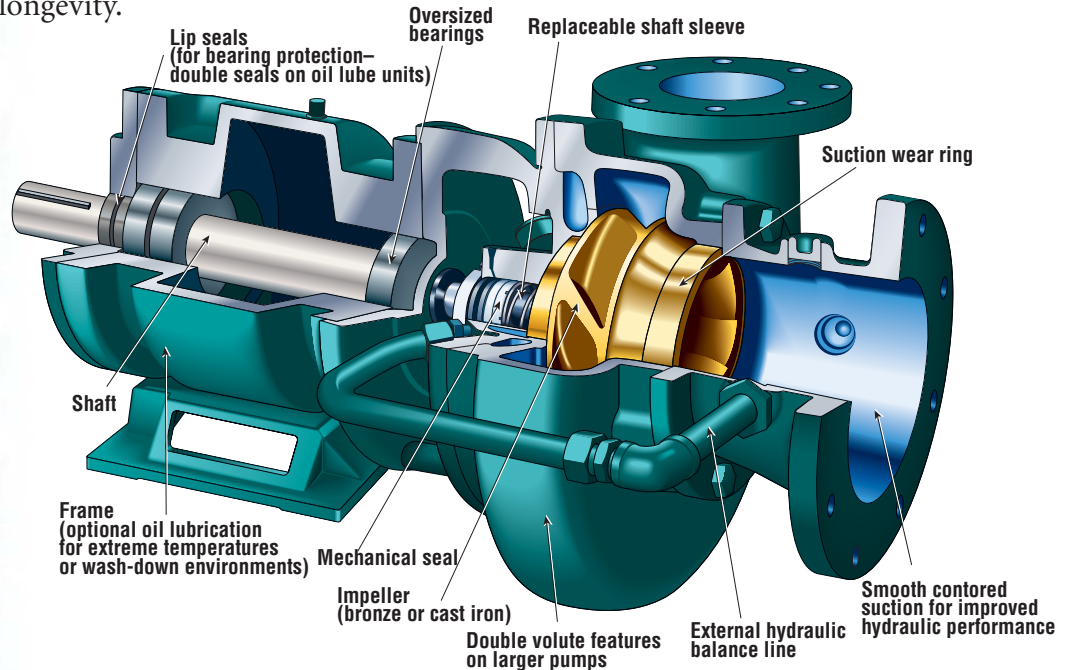

Quality Materials

Cornell's industrial process and wastewater pumps are constructed entirely of iron. Standard features include: dual-plane and dynamically balanced impellers, heavy-duty shafts with replaceable shaft sleeves, and replaceable wear ring(s). Other materials of construction are available as an option for abrasive or caustic applications.

H-Series

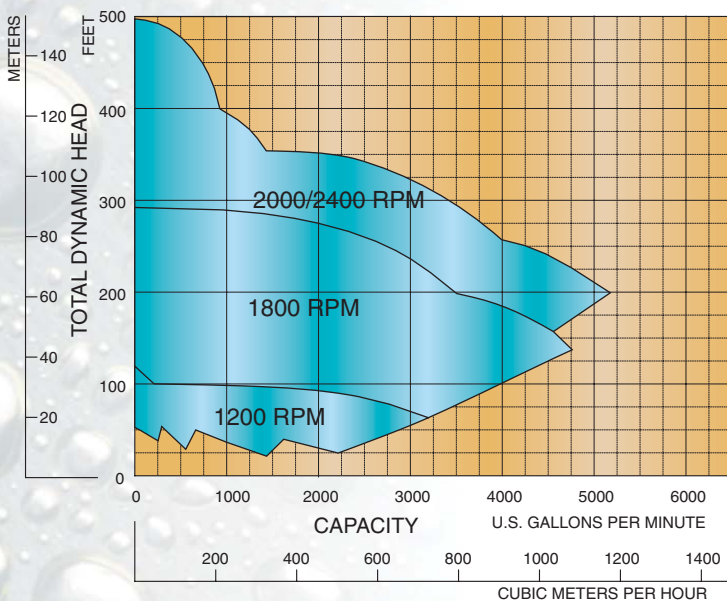

R-Series

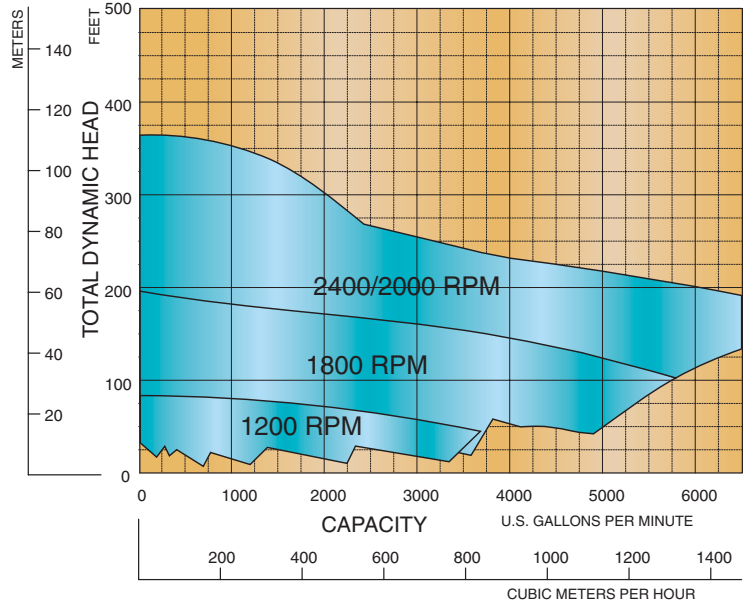

Energy Efficiency

Cornell pumps are designed to deliver *best in class efficiency*. Depending on operating hours, fuelant, and horsepower required, you can save \$3,000 per year (or more) in energy costs. Cornell manufactures *more than 60 clear liquid and non-clog pumps* that meet or exceed optimum efficiency standards for centrifugal pumps.

Select High Efficiency Pump Models:

- 8H – 88% efficient
- 6RB – 89% efficient
- 5RB – 86% efficient
- 4RB – 85% efficient

External Hydraulic Balance Line

Cornell's external hydraulic balance line equalizes pressure between the impeller hub area and the pump suction to reduce axial loading acting on the impeller, shaft and bearings. The balance line also assists in moving sand and silt from the stuffing box to the low pressure area at the pump suction, reducing wear of the wetted parts.

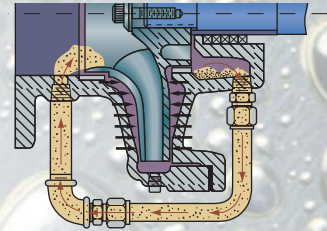

Double Volute

Cornell introduced the double volute as an industry first more than 30 years ago. The double volute system effectively balances forces within the pump to reduce radial load, shaft deflection and fatigue. This eliminates shaft breakage and extends the service life of packing and mechanical seals, wear rings and bearings while maintaining high hydraulic efficiency.

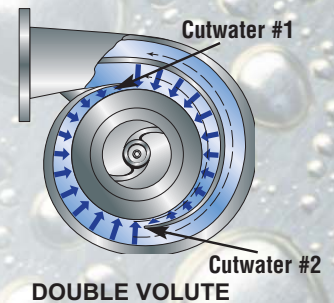

Y-Series

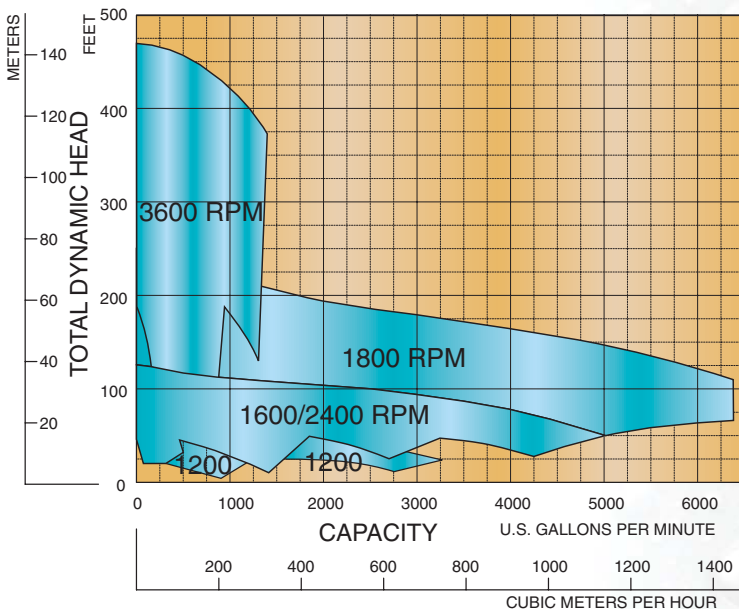

W-Series

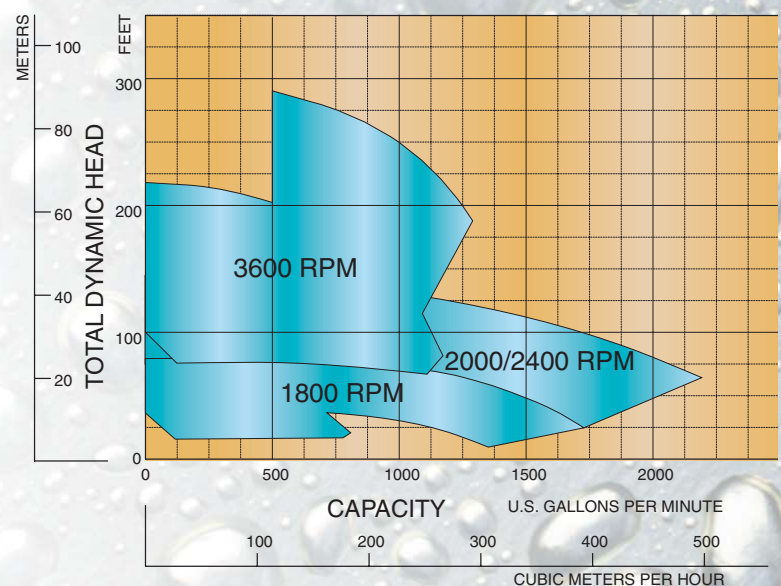

CONSTRUCTION & DEWATERING



SETTING THE STANDARD

Cornell's Redi-Prime® pumps are designed and engineered for the most rugged and demanding industries – construction, industrial, rental, and municipal.

With over 50 years of proven experience and reliability, Cornell Pump Company has established the highest industry standard for premium quality and performance in the most rugged conditions. Cornell pumps are backed by an industry-leading two-year warranty.

Cornell's dry priming (as opposed to wet priming) is the best solution available to address the self-priming needs of the construction and de-watering industries. Cornell has built its worldwide reputation on quality and reliability. Our Redi-Prime® pumps are engineered and manufactured to provide ultra-reliable, trouble-free operation. Hydraulic efficiencies typically exceed 80% – significantly higher than what is provided by our competition. Moreover, Cornell's automatic priming and re-priming is achieved with a 50 SCFM diaphragm vacuum pump.

Dewatering

Cornell's priming system was specifically designed with the environment in mind. By using a positive sealing float box and a diaphragm vacuum pump, there is absolutely no water carry-over to contaminate the environment. Cornell Redi-Prime® pumps are designed with the suction larger than the discharge. This provides more flow due to reduced friction losses. Suction lifts of 28 feet and heads of up to 470 feet are possible depending on suction losses and operating points on the pump curve.

REDI-PRIME® COMPONENTS

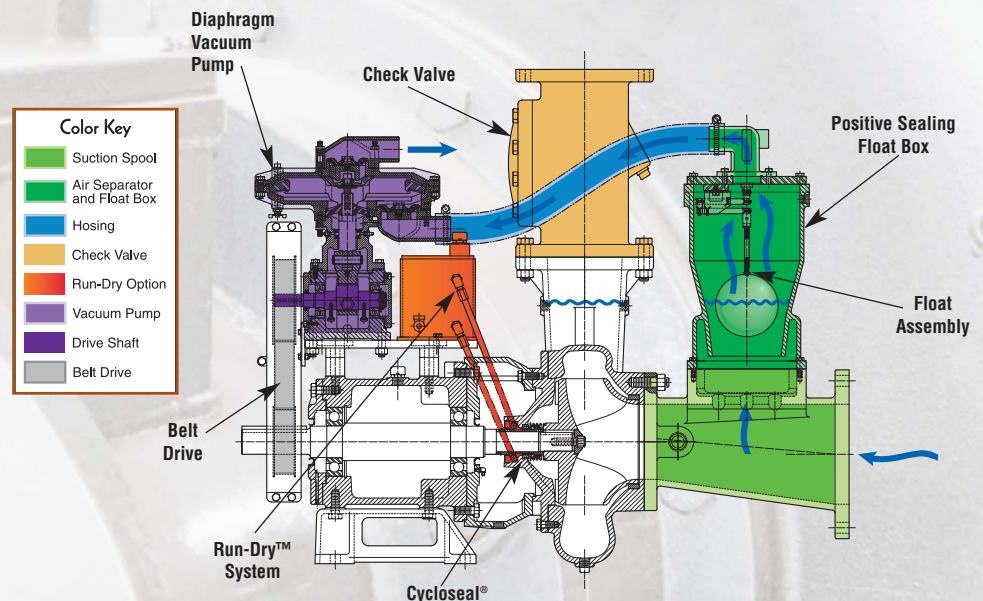

Redi-Prime® Benefits:

- Fully automatic self-priming, dry-prime pump.
- Handles air/liquid mixtures with ease.
- Rapidly primes and re-priming completely unattended.
- Environmentally safe priming system designed to prevent product leakage.
- Patented Cycloseal® and Run-Dry™ options.
- Handles large size solids.
- High suction lift capability up to 28 feet.
- Premium hydraulic efficiency for reduced energy consumption.
- Total dynamic head up to 470 feet.

REDI-PRIME® PUMPS

Pump options: Solids Handling Pumps

Model	Disch. Size	Max. Cap.	Max. Solids	Max. Head	Max. Suction Lift	RPM
4NNTL	4"	1,450 gpm	3"	175'	25'	2,500
4NNT	4"	1,400 gpm	3"	150'	25'	2,000
4NHTA	4"	1,400 gpm	3"	225'	25'	2,100
4414T	4"	1,400 gpm	3"	350'	25'	2,000
4NHTB	4"	1,600 gpm	3"	425'	25'	2,000
6NHTA	6"	2,700 gpm	3"	280'	25'	2,000
6NNT	6"	2,550 gpm	3"	150'	25'	2,100
6NHTB	6"	4,250 gpm	3.38"	350'	25'	1,800
8NNT	8"	4,500 gpm	3.38"	255'	25'	1,900
8NHTA	8"	5,000 gpm	3.38"	350'	25'	1,800
8NHTH	8"	6,250 gpm	4"	255'	25'	1,200
10NNT	10"	6,300 gpm	4"	340'	25'	1,800
10NHTB	10"	8,000 gpm	4.75"	195'	25'	1,200
10NHTA	10"	6,400 gpm	4.25"	245'	25'	1,200
12NHTL	12"	5,200 gpm	4.25"	140'	25'	1,500
12NNF	12"	8,500 gpm	3"	195'	25'	1,800
12NHG28	12"	12,000 gpm	3.2"	410'	25'	1,200
14NHG	14"	12,000 gpm	4"	210'	25'	1,500
14NHGH	14"	13,500 gpm	4.25"	145'	25'	1,200
14NHG28	14"	15,000 gpm	4.25"	430'	25'	1,200
16NHGH	16"	13,500 gpm	4.25"	175'	25'	1,200
16NHG22	16"	16,500 gpm	4.5"	265'	25'	1,200
18NHG	18"	22,000 gpm	5"	220'	25'	900
18NHFL	18"	26,000 gpm	5"	190'	25'	890
18NHFL34	18"	22,000 gpm	4.5"	320'	25'	900
20NHFL	20"	18,000 gpm	5"	116'	25'	720
24NNG	24"	32,000 gpm	5.25"	135'	25'	750
30NNT	30"	38,000 gpm	10.2"	110'	25'	585



Pump options: Clear Liquid Pumps

Model	Disch. Size	Max. Cap.	Max. Solids	Max. Head	Max. Suction Lift	RPM
2.5RB	2.5"	400 gpm	.38"	300'	25'	2,200
2.5H	2.5"	500 gpm	.41"	360'	25'	2,200
2.5YH	2.5"	750 gpm	.41"	310'	28'	3,000
3HC/HA	3"	1,050 gpm	.5"	490'	28'	2,400
3RB	3"	800 gpm	.5"	280'	28'	2,200
3YL/YH	3"	1,100 gpm	.5"	245'	28'	2,700
4HC	4"	1,650 gpm	.62"	470'	28'	2,150
4RB	4"	1,550 gpm	.84"	270'	25'	2,200
5HH	5"	2,900 gpm	.75"	375'	25'	2,000
5RB	5"	2,350 gpm	1"	360'	25'	2,400
5YBH	5"	2,500 gpm	.75"	200'	25'	2,400
6HH	6"	4,000 gpm	1.22"	365'	25'	2,000
6RB	6"	4,250 gpm	1.31"	300'	28'	2,200
6YB	6"	4,100 gpm	.75"	235'	25'	2,400
8H	8"	5,400 gpm	1.25"	305'	25'	2,000
10RB	10"	7,000 gpm	1.25"	300'	25'	2,200
10YB	10"	6,500 gpm	1.38"	200'	25'	2,300



REFRIGERATION & COOLING

QUALITY ASSURANCE

Cornell Pump Company proudly maintains its ISO 9001:2000 certification which validates that Cornell is in compliance with all necessary processes to meet customer requirements.

The elements associated with ISO 9001:2000 certification include such areas as contract review, design and development, production, purchasing, quality control and service.

Cornell liquid over-feed and transfer pumps are designed and manufactured specifically for industrial refrigeration applications such as cold storage, food processing, ice chiller, and turbine inlet cooling. With decades of proven experience and reliability, Cornell has established the highest industry standard for premium quality performance in meeting the demands of the industrial refrigeration marketplace. Our products are engineered to be rugged and dependable; each Cornell refrigeration pump is backed by an industry-leading three-year warranty.

Industrial Refrigeration

Enhanced vapor handling and NPSHR characteristics are at the heart of Cornell's liquid overfeed pump innovations and we have incorporated these design features into our liquid overfeed and transfer pump designs. Cornell refrigerant pumps are commonly employed in applications utilizing anhydrous ammonia, aqueous ammonia, halocarbon such as R-22, and other approved refrigerants. The pumps are designed specifically to handle moderate to high pressure differentials.

Cornell's refrigeration product line offers the customer a choice between the standard "Refrigerant Emission Free" sealing technology or our Seal-less hermetic technology. Both offer dynamic containment systems capable of continuous and reliable operation.

Saturated Liquids

Cornell Pump Company's CBH/CB pump series are a welcome alternative to regenerative turbines, especially for requirements associated with boiler feed, condensate return and other saturated liquid applications. Cornell's single stage centrifugal CBH/CB pumps are capable of achieving capacities up to 400 GPM and pressure differentials of 140 PSI while maintaining *NPSH requirements of less than two feet.*

The extremely low NPSH requirements of all Cornell CBH/CB pumps are derived from hydraulics designed specifically for saturated liquid applications. Performance is further enhanced throughout the entire operating range of all Cornell CBH/CB series pumps due to the single-stage impeller and 1800 RPM operating speed. Operating speeds above 1800 RPM are available for applications associated with higher head requirements.

Glycol

In many refrigeration applications, secondary coolants such as ethylene and propylene glycols are used as heat transfer media. The secondary brine is cooled by the primary refrigerant and used to transmit heat without changing state. Cornell's clear-liquids-handling pumps are commonly used to recirculate the secondary coolants. These pumps are rugged, extremely efficient and designed specifically for a long life of service.



FOOD PROCESSING

Hydro-Transport Food Handling

Cornell engineers understand the important role food handling pumps play in today's marketplace. Cornell's innovative single port impeller configuration with an offset volute* provides the end user with a food handling pump capable of transporting even the most delicate or difficult food products such as cherries, lettuce, potatoes, or carrots. Cornell's unique single port impeller reduces product damage and ensures product integrity. The single port impeller is a proven feature consisting of a large and rounded leading vane edge designed specifically for handling whole or processed foods.

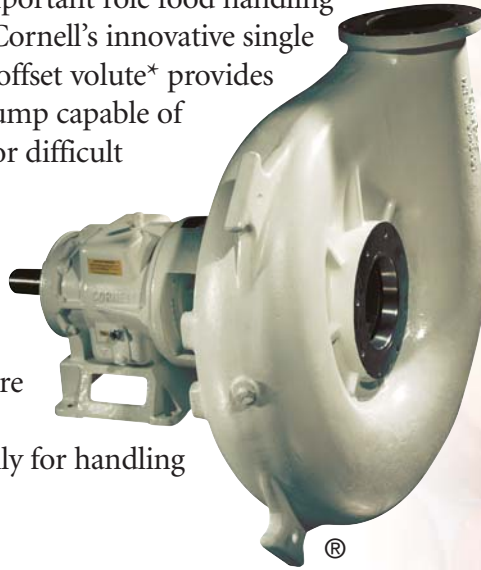

Hot Cooking Oil

Enhanced vapor handling and NPSHR characteristics are central to Cornell's latest hot cooking oil pump innovations. When fresh product passes through the fryers a great deal of water is evolved. The water travels along the bottom of the fryer, intact, in a liquid phase at 392° F (200° C), until it reaches the pump suction where the action of the impeller breaks the water up into smaller droplets that flash into steam.



Ordinarily, entrained steam would severely impair the pump's head and flow, but another Cornell innovation prevents this type of reduced efficiency. The 'vapor suppression line' was developed in response to this phenomenon.

Food Process & Waste

Cornell's food product group is not limited to food handling and hot cooking oil applications. Cornell's process and waste pumps are frequently used in starch recovery, water return, circulation, chilled water, food product waste and many other food process applications. Cornell's clear liquid pumps are constructed entirely of iron for food applications. Many optional metalurgies are also available. Standard features include fully machined impellers, heavy-duty shafts with replaceable shaft sleeves, and peripheral wear rings.



MANUFACTURING

Cornell pumps are of superior quality, with each part machined and built to our exacting standards.

Our team of exceptional machinists, craftsmen and assembly mechanics work with some of the most modern manufacturing machinery and hydraulic testing equipment in the world to bring our customers a state-of-the-art product.

* Cornell's offset volute configuration is registered in the U.S. Patent and Trademark Office.

ENERGY RECOVERY



COMMITMENT TO EXCELLENCE

“As Cornell employees, we share the commitment to meet the requirements of our customers. We will provide services, parts, and products that satisfy all the agreed upon requirements.

We shall strive for a working environment of continual improvement by keeping the following priorities in mind:

1. Achieve total satisfaction on the basis of team effort.
2. Do the job right the first time to achieve consistent, on-time performance.
3. Put quality first. If all requirements have not been met, we will never knowingly complete a service, transaction, or ship a part or product for the sake of ‘being on time’”.

Turbine Applications

Many industrial operations are able to harness the potential hydraulic energy sources required to produce electric power as a revenue source or as a means of reducing overall energy demands.

The key to our system is the recovery of excess head from a river, stream, or pipeline to drive a Cornell turbine. The turbine may be used to drive a pump, a generator or other power requiring device.

With power production available from 1 kW to 300 kW, Cornell’s range of high-efficiency turbines can generate enough power to pay for themselves in a very short time.

Whether you require a single or parallel unit, Cornell engineers and sales personnel can provide specialty application assistance.



AVAILABLE OPTIONS

Mounting Configurations

Cornell's modular frame design allows for easy adaptability.

Choose a pump, then pick the mounting configuration best suited to your application.

Right hand and left hand rotation along with tangential or centerline discharges are available for most pumps.

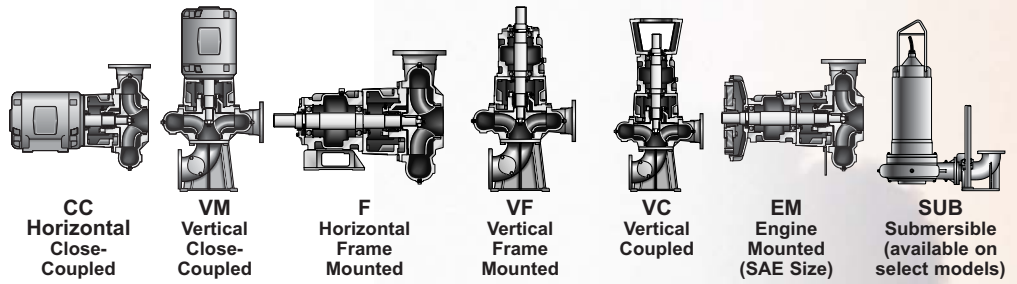

Cycloseal®

Cornell's Cycloseal® (U.S. Patent #5,489,187) lasts many times longer than a typical mechanical seal. This saves on the installed cost of a seal water system and its on-going maintenance not to mention the savings of thousands of gallons of seal water over the life of the pump. No seal flush, no vent line and no lubrication is required for this seal. The Cycloseal® design is available in all waste handling pumps and many clear liquid pumps.

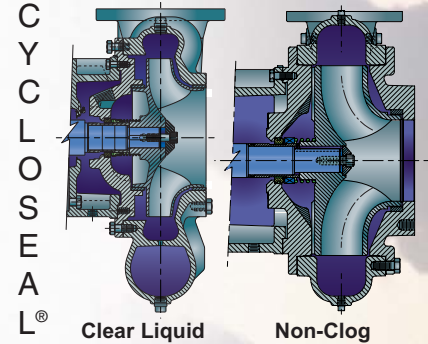

Run-Dry™ Option

Run-Dry™ is a great feature for protecting your mechanical seal. It allows your pump to run dry without the use of expensive water systems and without mechanical seal damage.

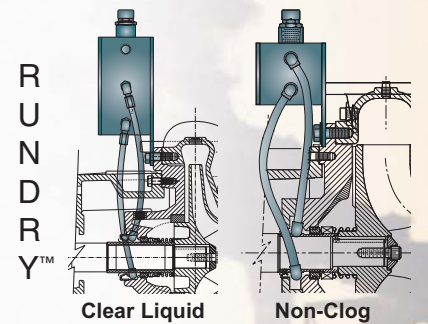

Material Options

Cast iron, Ductile Iron, Heat-Treated Ductile Iron, Bronze, Navy Bronze, various Stainless Steel grades including Duplex and Super Duplex Stainless Steel, and other materials are available to meet your application needs.

Double Volute Design

The double volute system enables Cornell single-stage, end-suction centrifugal pumps to easily perform big volume and high pressure jobs. On single volute pumps, the increasing pressure acts against the impeller area and creates unbalanced radial forces. By contrast, the Double Volute System effectively balances these forces around the impeller to reduce shaft flexure and fatigue for longer seal life, bearing life and shaft life. The Double Volute is a standard feature on larger pump models.

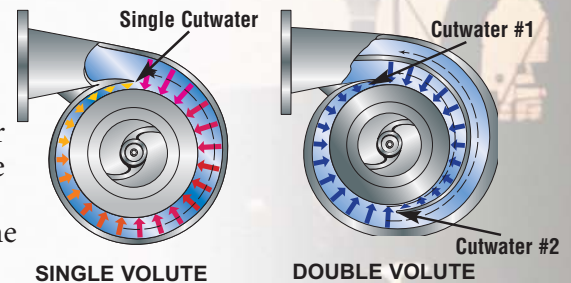

PUTTING IDEAS TO THE TEST

Test Lab

Cornell's test lab is the proving ground for all of our pumps where our goal is to engineer and manufacture the best performing, most efficient pumps on the market. Test Lab technicians, under the supervision of Registered Professional Engineers, perform research and development as well as conduct certified performance, NPSH, and vibration testing.

The focal point of the test lab is an 80,000 gallon open loop testing system with calibrated flow meters from 2.5" through 20" in size. In our closed loop testing system, with flow meters up to 36" diameter, we can test pumps up to 60,000 gallons per minute.

The test lab is also equipped with an 800 HP VFD and multiple transformers to test motors with voltages ranging anywhere from 120 to 4160 volts. For motor sizes above 800 HP we use a portable generator.





Cornell Pump Company

Portland, Oregon U.S.A.

Phone: (503) 653-0330
Fax: (503) 653-0338
Web: www.cornellpump.com

Cycloseal® and Redi-Prime® are Registered Trademarks of Cornell Pump Company.

Cornell pumps and products are the subject of one or more of the following U.S. and Foreign patents: 3,207,485; 3,282,226; 3,295,456; 3,301,191; 3,630,637; 3,663,117; 3,743,437; 4,335,886; 4,523,900; 5,489,187; 5,591,001; 6,074,554; 6,036,434; 6,079,958; 6,309,169; 2,320,742; 96/8140; 319,837; 918,534; 1,224,969; 2,232,735; 701,979 and are the subject of pending U.S. and Foreign Patent Applications.

CERTIFIED TO ISO 9001:2000



The Cornell Product Line:

Agricultural



IRRIGATION & SLURRY

Industrial

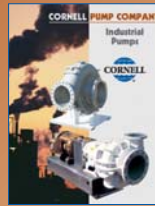

PROCESSING



FOOD

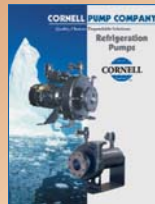

REFRIGERATION

Municipal



WASTE WATER & CONSTRUCTION



HYDRO-ENERGY

All Markets



RENTAL