



Product Catalog

Air-Cooled Series R® Chillers Model RTAC

140 to 500 nominal tons (60 Hz)





Introduction

Like its chillers, Trane wants its relationships with customers to last. Trane is interested in maintaining long term, loyal relationships. This perspective means the point in time that a customer purchases a chiller is the beginning of a relationship, not the end. Your business is important, but your satisfaction is paramount.

The RTAC offers high reliability coupled with proven Series R® performance.

The Series R® Model RTAC is an industrial grade design built for both the industrial and commercial markets. It is ideal for schools, hospitals, retailers, office buildings, internet service providers and manufacturing facilities.

Copyright

This document and the information in it are the property of Trane, and may not be used or reproduced in whole or in part without written permission. Trane reserves the right to revise this publication at any time, and to make changes to its content without obligation to notify any person of such revision or change.

Trademarks

All trademarks referenced in this document are the trademarks of their respective owners.

Revision History

Corrected electrical data table formatting.



Table of Contents

Introduction	2
Features and Benefits	4
Application Considerations	7
Model Number Descriptions	13
General Data	14
Controls	20
Electrical Data	24
Electrical Connection	54
Dimensions	62
Weights	72
Non-Seismically Rated Units	72
Seismically Rated Units	73
Mechanical Specifications	74
Options	76



Features and Benefits

World Class Energy Efficiency

The importance of energy efficiency cannot be understated. Fortunately, ASHRAE has created a guideline emphasizing its importance. Nonetheless, energy is often dismissed as an operational cost over which the owner has little control. That perception results in missed opportunities for energy efficiency, reduced utility bills, and higher profits. Lower utility bills directly affect profitability. Every dollar saved in energy goes directly to the bottom line. Trane's RTAC is one way to maximize your profits.

ASHRAE Standard 90.1 and Executive Order

All Trane air-cooled chillers meet the new efficiency levels mandated by ASHRAE Standard 90.1. This new standard requires higher efficiencies than past technologies can deliver. The US Federal Government has adopted standard 90.1 and, in some cases, requires even higher efficiencies. Federal Executive Order mandates energy consuming devices procured must be in the top 25% of their class. In the case of chillers, that product standard is ASHRAE 90.1. Trane's RTAC meets and exceeds the efficiency requirements of 90.1, while the high and extra efficiency RTAC can meet the "stretch goals" of Executive Order.

Precise Capacity Control

Trane's patented unloading system allows the compressor to modulate infinitely and exactly match building loads. At the same time chilled water temperatures will be maintained within +/- 1/2°F (0.28°C) of setpoint. Screw or scroll chillers with stepped capacity control do well to maintain chilled water temperatures within 2°F (1.1°C) of setpoint. Stepped control also results in over cooling because rarely does the capacity of the machine match the building load. The result can be 10% higher energy bills. Trane's RTAC optimizes the part load performance of your machine for energy efficiency, precise control for process applications, and your personal comfort regardless of the weather outside.

Excellent Reliability

A buildings environment is expected to be comfortable. When it is, no one says a word. If it's not... that's a different story. The same is true with chillers. No one ever talks about chillers, yet alone compressors, until they fail, and tenants are uncomfortable and productivity is lost. Trane's helical rotary compressors have been designed and built to stay running when you need them.

Fewer moving parts

Trane's helical rotary compressors have only two major rotating parts: the male and female rotor. A reciprocating compressor can have more than 15 times that number of critical parts. Multiples of pistons, valves, crankshafts, and connecting rods in a reciprocating unit all represent different failure paths for the compressor. In fact, reciprocating compressors can easily have a failure rate four times of a helical rotor. Combine that with two to three reciprocating compressors for each helical rotary compressor on chillers of equal tonnage, and statistics tell you it's a matter of time before you lose a reciprocating compressor.

Robust components

Helical rotary compressors are precisely machined using state of the art processes from solid metal bar stock. Tolerances are maintained within a micron or less than a tenth of the diameter of a human hair. The resulting compressor is a robust yet highly sophisticated assembly capable of ingesting liquid refrigerant without risk of damage.

Condenser coils

Trane's condenser coils are manufactured with the same philosophy as the compressors; they're built to last. Even though manufacturing processes have allowed thinner and thinner materials in their assembly, with obvious material and manufacturing savings, Trane's coil material did not change with the RTAC generation of air cooled chillers. Substantial condenser fins, that do not require additional coating in non-corrosive environments, contribute to the highest reliability standards for air-cooled chillers in the industry.

Superior Control

The Adaptive Control™ microprocessor system enhances the air-cooled Series R® chiller by providing the very latest chiller control technology. With the Adaptive Control microprocessor, unnecessary service calls and unhappy tenants are avoided. The unit is designed not to trip or unnecessarily shut down. Only when the Tracer® chiller controllers have exhausted all possible corrective actions and the unit is still violating an operating limit will the chiller shut down. Controls on other equipment typically shut down the chiller, usually just when it is needed the most.

For example: A typical five year old chiller with dirty coils might trip out on high pressure cutout on a 100°F (38°C) day in August. A hot day is just when comfort cooling is needed the most. In contrast, the air-cooled Series R® chiller with an Adaptive Control microprocessor will stage fans on, modulate electronic expansion valves, and modulate slide valve positions as the chiller approaches a high pressure cutout, thereby keeping the chiller online when you need it the most.

Simple Installation

- **Factory Installed Flow Switch.** Installed in the optimum location in the piping for reduced chiller installation cost and superior flow sensing, reducing the potential for nuisance trips.
- **Close Spacing Installation.** The air-cooled Series R™ Chiller has the tightest recommended side clearance in the industry, four feet for maximum performance. In situations where equipment must be installed with less clearance than recommended, which frequently occurs in retrofit applications, restricted airflow is common. Conventional chillers may not work at all. However, the air-cooled Series R chiller with Adaptive Control™ microprocessor will make as much chilled water as possible given the actual installed conditions, stay on line during unforeseen abnormal conditions, and optimize the unit performance. Consult your Trane sales engineer for more details.
- **Factory Testing Means Trouble Free Startup.** All air-cooled Series R® chillers are given a complete functional test at the factory. This computer based test program completely checks the sensors, wiring, electrical components, microprocessor function, communication capability, expansion valve performance and fans. In addition, each compressor is run and tested to verify capacity and efficiency. Where applicable, each unit is factory preset to the customer's design conditions; an example would be leaving liquid temperature setpoint. The result of this test program is that the chiller arrives at the job site fully tested and ready for operation.
- **Factory Installed and Tested Controls/Options Speed Installation.** All Series R® chiller options, including main power supply disconnect, low ambient control, ambient temperature sensor, low ambient lockout, communication interface and ice making controls, are factory installed and tested. Some manufacturers send accessories in pieces to be field installed. With Trane, the customer saves on installation expense and has assurance that ALL chiller controls/options have been tested and will function as intended.

Unit Performance Testing

The AHRI Certification Program has had a certification program covering air-cooled water chillers for many years. With this in mind, customers may ask, “Do I need to factory performance test my chiller?”

Trane began promoting factory performance tests for water-cooled water chillers in 1984 for the same reasons it is valid today for air-cooled water chillers, to show we stand behind the products we design and build.

The benefits of a performance test include verification of performance, prevention of operational problems, and assurance of a smooth startup. Only a performance test conducted in a laboratory or laboratory grade facility will confirm both performance and operation of a specific chiller.

While most factory performance tests go smoothly, should problems occur, Trane personnel can quickly correct them and the chiller will ship as specified. Job site diagnosis, ordering of parts, and waiting for delivery of replacement components is significantly reduced.

A factory performance test reduces startup time, thereby saving job site expense. A chiller that has been tested is operation and performance proven. This allows the installing contractor to concentrate on proper electrical wiring and water piping, and the service technicians to concentrate on proper refrigerant charge, safeties diagnosis and initial logging of the chiller. Means of obtaining full load on the chiller and proving its performance do not have to be determined by engineers or contractors, thus saving time. The certified test report documents performance for the unit as built. In addition, factory testing significantly reduces commissioning time and risk by reintroducing manufacturer responsibility, where its mitigation should reside.

When a factory performance test is requested, the test can be conducted at the specified design conditions for all packaged chillers. The test facility has the capability to control ambient test conditions to assure our customers that our chillers will perform as predicted.

Rapid Restart™ testing is also available to demonstrate the chiller’s rapid restart capabilities for disaster relief. While the chiller is operating at customer specified full load conditions, power to the chiller is cut and the customer can witness how quickly the chiller will return to full load.

For more information on test performance testing, see brochure RF-SLB012-EN.





Application Considerations

Important

Certain application constraints should be considered when sizing, selecting and installing Trane air-cooled Series R[®] chillers. Unit and system reliability is often dependent upon proper and complete compliance with these considerations. When the application varies from the guidelines presented, it should be reviewed with your local Trane sales engineer.

Unit Sizing

Unit capacities are listed in the performance data section. Intentionally over sizing a unit to assure adequate capacity is not recommended. Erratic system operation and excessive compressor cycling are often a direct result of an oversized chiller. In addition, an oversized unit is usually more expensive to purchase, install, and operate. If over sizing is desired, consider using multiple units.

Water Treatment

Dirt, scale, products of corrosion and other foreign material will adversely affect heat transfer between the water and system components. Foreign matter in the chilled water system can also increase pressure drop and consequently, reduce water flow. Proper water treatment must be determined locally, depending on the type of system and local water characteristics. Neither salt nor brackish water is recommended for use in Trane air-cooled Series R[®] chillers. Use of either will lead to a shortened life to an indeterminable degree. The Trane Company encourages the employment of a reputable water treatment specialist, familiar with local water conditions, to assist in this determination and in the establishment of a proper water treatment program.

Effect Of Altitude On Capacity

Air-cooled Series R[®] chiller capacities given in the performance data tables are for use at sea level. At elevations substantially above sea level, the decreased air density will reduce condenser capacity and, therefore, unit capacity and efficiency.

Ambient Limitations

Trane air-cooled Series R[®] chillers are designed for year round operation over a range of ambient temperatures. The Model RTAC chiller will operate as standard in ambient temperatures of 25 to 115°F (-4 to 46°C). With the low ambient option, these units will operate down to 0°F (-18°C). If an ambient temperature as high as 125°F (51°C) is the basis for design, the high ambient option will permit the chiller to run without going into a limiting condition. For installations in areas with large ambient differences, the wide ambient option will allow the chiller to perform uninhibited from 0 to 125°F (-18 to 51°C).

Water Flow Limits

The minimum and maximum water flow rates are given in the General Data tables. Evaporator flow rates below the tabulated values will result in laminar flow causing freeze up problems, scaling, stratification and poor control. Flow rates exceeding those listed may result in excessive tube erosion.

Note: Flow rates in General Data tables are for water only. They do not include glycol.

Leaving Water Temperature Limits

Trane air-cooled Series R chillers have three distinct leaving water categories: standard, low temperature, and ice making. The standard leaving solution temperature range is 40 to 65°F (4.4 to 15.6°C). Low temperature machines produce leaving liquid temperatures less than 40°F (4.4°C). Since liquid supply temperature setpoints less than 40°F (4.4°C) result in suction temperatures at or below the freezing point of water, a glycol solution is required for all low temperature machines. Ice making machines have a leaving liquid temperature range of 20 to 60°F (-6.7 to 15.6°C). Ice making controls include dual setpoint controls and safeties for ice making and standard cooling capabilities. Consult your local Trane sales engineer for applications or selections involving low

Application Considerations

temperature or ice making machines. The maximum water temperature that can be circulated through an evaporator when the unit is not operating is 108°F (42°C).

Flow Rates Out of Range

Many process cooling jobs require flow rates that cannot be met with the minimum and maximum published values for the Model RTAC evaporator. A simple piping change can alleviate this problem. For example: A plastic injection molding process requires 80 gpm (5.1 l/s) of 50°F (10°C) water and returns that water at 60°F (15.6°C). The selected chiller can operate at these temperatures, but has a minimum flow rate of 120 gpm (7.6 l/s). The system layout in Figure A1 can satisfy the process.

Figure 1. Flow rate out of range system layout

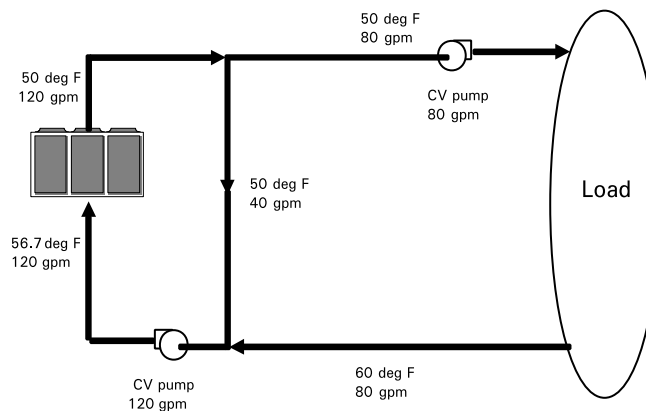

Flow Control

Trane requires the chilled water flow control in conjunction with the air-cooled Series R[®] chiller to be done by the chiller. This will allow the chiller to protect itself in potentially harmful conditions.

Supply Water Temperature Drop

The performance data for the Trane air-cooled Series R[®] chiller is based on a chilled water temperature drop of 10°F (5.6°C). Chilled water temperature drops from 6 to 18°F (3.3 to 10°C) may be used as long as minimum and maximum water temperatures and flow rates are not violated. Temperature drops outside this range are beyond the optimum range for control and may adversely affect the microcomputer's ability to maintain an acceptable supply water temperature range. Further, temperature drops of less than 6°F (3.3°C) may result in inadequate refrigerant superheat. Sufficient superheat is always a primary concern in any refrigerant system and is especially important in a package chiller where the evaporator is closely coupled to the compressor. When temperature drops are less than 6°F (3.3°C), an evaporator runaround loop may be required.

Leaving Water Temperature Out of Range

Many process cooling jobs require temperature ranges that cannot be met with the minimum and maximum published values for the Model RTAC evaporator. A simple piping change can alleviate this problem. For example: A laboratory load requires 120 gpm (7.6 l/s) of water entering the process at 85°F (29.4°C) and returning at 95°F (35°C). The accuracy required is better than the cooling tower can give. The selected chiller has adequate capacity, but a maximum leaving chilled water temperature of 60°F (15.6°C).

In [Figure 2, p. 9](#), both the chiller and process flow rates are equal. This is not necessary. For example, if the chiller had a higher flow rate, there would simply be more water bypassing and mixing with warm water.

Figure 2. Temperature out of range system layout

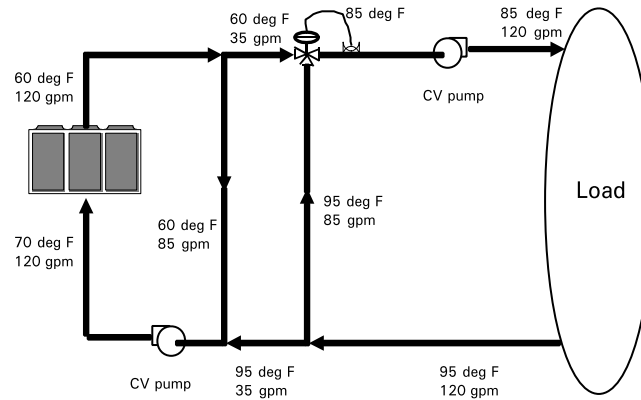

Variable Flow in the Evaporator

An attractive chilled water system option may be a variable primary flow (VPF) system. VPF systems present building owners with several cost saving benefits that are directly related to the pumps. The most obvious cost savings result from eliminating the secondary distribution pump, which in turn avoids the expense incurred with the associated piping connections (material, labor), electrical service, and variable frequency drive. Building owners often cite pump related energy savings as the reason that prompted them to install a VPF system.

The evaporator on the Model RTAC can withstand up to 50 percent water flow reduction as long as this flow is equal to or above the minimum flow rate requirements. The microprocessor and capacity control algorithms are designed to handle a maximum of 10% change in water flow rate per minute in order to maintain $\pm 0.5^{\circ}\text{F}$ (0.28°C) leaving evaporator temperature control. For applications in which system energy savings is most important and tight temperature control is classified as $\pm 2^{\circ}\text{F}$ (1.1°C), up to 30 percent changes in flow per minute are possible.

With the help of a software analysis tool such as System Analyzer™, DOE-2 or TRACE™, you can determine whether the anticipated energy savings justify the use of variable primary flow in a particular application. It may also be easier to apply variable primary flow in an existing chilled water plant. Unlike the “decoupled” system design, the bypass can be positioned at various points in the chilled water loop and an additional pump is unnecessary.

Series Chiller Arrangements

Another energy saving strategy is to design the system around chillers arranged in series. The actual savings possible with such strategies depends on the application dynamics and should be researched by consulting your Trane Systems Solutions Representative and applying an analysis tool from the Trace software family. It is possible to operate a pair of chillers more efficiently in a series chiller arrangement than in a parallel arrangement. It is also possible to achieve higher entering to leaving chiller differentials, which may, in turn, provide the opportunity for lower chilled water design temperature, lower design flow, and resulting installation and operational cost savings. The Trane screw compressor also has excellent capabilities for “lift,” which affords an opportunity for “lift,” which affords an opportunity for savings on the evaporator water loop.

Series chiller arrangements can be controlled in several ways. Figure A3 shows a strategy where each chiller is trying to achieve the system design set point. If the cooling load is less than 50 percent of the systems capabilities, either chiller can fulfill the demand. As system loads increase, the Chiller 2 becomes preferentially loaded as it attempts to meet the leaving chilled water setpoint. Chiller 1 will finish cooling the leaving water from Chiller 2 down to the system design setpoint.

Staggering the chiller set points is another control technique that works well for preferentially loading Chiller 1. If the cooling load is less than 50 percent of the system capacity, Chiller 1 would

Application Considerations

be able to satisfy the entire call for cooling. As system loads increase, Chiller 2 is started to meet any portion of the load that Chiller 1 can not meet.

Figure 3. Typical series chiller arrangement

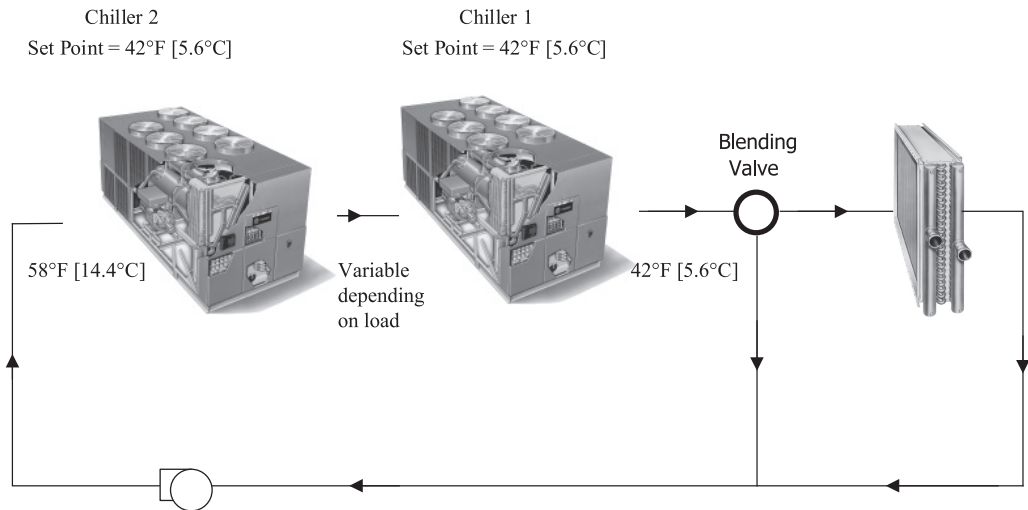

Typical Water Piping

All building water piping must be flushed prior to making the final connections to the chiller. To reduce heat loss and prevent condensation, insulation should be installed. Expansion tanks are also usually required so that chilled water volume changes can be accommodated.

Short Water Loops

The proper location of the temperature control sensor is in the supply (outlet) water connection or pipe. This location allows the building to act as a buffer and assures a slowly changing return water temperature. If there is not a sufficient volume of water in the system to provide an adequate buffer, temperature control can be lost, resulting in erratic system operation and excessive compressor cycling. A short water loop has the same effect as attempting to control from the building return water. Typically, a two minute water loop is sufficient to prevent problems. Therefore, as a guideline, ensure the volume of water in the evaporator loop equals or exceeds two times the evaporator flow rate in gallons per minute. For a rapidly changing load profile, the amount of volume should be increased. To prevent the effect of a short water loop, the following items should be given careful consideration: A storage tank or larger header pipe to increase the volume of water in the system and, therefore, reduce the rate of change of the return water temperature.

Applications Types

- Comfort cooling.
- Industrial process cooling.
- Ice/thermal storage.
- Low temperature process cooling.

Typical Unit Installation

Outdoor HVAC equipment must be located to minimize noise and vibration transmission to the occupied spaces of the building structure it serves. If the equipment must be located in close proximity to a building, it could be placed next to an unoccupied space such as a storage room, mechanical room, etc. It is not recommended to locate the equipment near occupied, sound

sensitive areas of the building or near windows. Locating the equipment away from structures will also prevent sound reflection, which can increase levels at property lines, or other sensitive points.

When physically isolating the unit from structures, it is a good idea to not use rigid supports, and to eliminate any metal-to-metal or hard material contact, when possible. This includes replacing spring or metal weave isolation with elastomeric isolators. Figure A4 illustrates isolation recommendations for the RTAC.

For chiller sound ratings, installation tips and considerations on chiller location, pipe isolation, etc., refer to the Trane Air-Cooled Series R Chillers Sound Data and Application Guide for Noise Sensitive Installations.

System Options - Ice Storage

Trane air-cooled Series R[®] Chillers are well suited for ice production. An air-cooled machine typically switches to ice production at night. Two things happen under this assumption. First, the leaving brine temperature from the evaporator is lowered to around 22 to 24°F (-5.5 to -4.4°C). Second, the ambient temperature has typically dropped about 15 to 20°F (8.3 to 11°C) from the peak daytime ambient. This effectively places a lift on the compressors that is similar to daytime running conditions. The chiller can operate in lower ambient at night and successfully produce ice to supplement the next day's cooling demands.

The Model RTAC produces ice by supplying ice storage tanks with a constant supply of glycol solution. Air-cooled chillers selected for these lower leaving fluid temperatures are also selected for efficient production of chilled fluid at nominal comfort cooling conditions. The ability of Trane chillers to serve "double duty" in ice production and comfort cooling greatly reduces the capital cost of ice storage systems.

When cooling is required, ice chilled glycol is pumped from the ice storage tanks directly to the cooling coils. No expensive heat exchanger is required. The glycol loop is a sealed system, eliminating expensive annual chemical treatment costs. The air-cooled chiller is also available for comfort cooling duty at nominal cooling conditions and efficiencies. The modular concept of glycol ice storage systems and the proven simplicity of Trane Tracer controllers allow the successful blend of reliability and energy saving performance in any ice storage application.

The ice storage system is operated in six different modes: each optimized for the utility cost of the hour.

1. Provide comfort cooling with chiller
2. Provide comfort cooling with ice
3. Provide comfort cooling with ice and chiller
4. Freeze ice storage
5. Freeze ice storage when comfort cooling is required
6. Off

Tracer optimization software controls operation of the required equipment and accessories to easily transition from one mode of operation to another. For example:

Even with ice storage systems there are numerous hours when ice is neither produced or consumed, but saved. In this mode the chiller is the sole source of cooling. For example, to cool the building after all ice is produced but before high electrical demand charges take effect, Tracer sets the air-cooled chiller leaving fluid setpoint to its most efficient setting and starts the chiller, chiller pump, and load pump.

When electrical demand is high, the ice pump is started and the chiller is either demand limited or shut down completely. Tracer controls have the intelligence to optimally balance the contribution of ice and chiller in meeting the cooling load.

The capacity of the chiller plant is extended by operating the chiller and ice in tandem. Tracer rations the ice, augmenting chiller capacity while reducing cooling costs. When ice is produced, Tracer will lower the air-cooled chiller leaving fluid setpoint and start the chiller, ice and chiller pumps, and



Application Considerations

other accessories. Any incidental loads that persist while producing ice can be addressed by starting the load pump and drawing spent cooling fluid from the ice storage tanks.

For specific information on ice storage applications, contact your local Trane sales office.



Model Number Descriptions

Digits 1, 2 - Unit Model

RT = Rotary chiller

Digit 3 - Unit Type

A = Air-cooled

Digit 4 - Development Sequence

C = Development sequence

Digits 5, 6 & 7 - Nominal Capacity

140 = 140 Nominal tons
155 = 155 Nominal tons
170 = 170 Nominal tons
185 = 185 Nominal tons
200 = 200 Nominal tons
225 = 225 Nominal tons
250 = 250 Nominal tons
275 = 275 Nominal tons
300 = 300 Nominal tons
350 = 350 Nominal tons
400 = 400 Nominal tons
450 = 450 Nominal tons
500 = 500 Nominal tons

Digit 8 - Unit Voltage

A = 200/60/3
C = 230/60/3
J = 380/60/3
4 = 460/60/3
5 = 575/60/3

Digit 9 - Manufacturing Location

U = Water Chiller Business Unit,
Pueblo, CO USA

Digits 10, 11 - Design Sequence

** = Factory Input

Digit 12 - Unit Basic Configuration

N = Standard efficiency/performance
H = High efficiency/performance
A = Extra efficiency/performance

Digit 13 - Agency Listing

N = No agency listing
U = C/UL listing
S = Seismic rated - IBC and OSHPD
R = C/UL listed and seismic rated

Digit 14 - Pressure Vessel Code

A = ASME pressure vessel code
C = Canadian code
D = Australian code
L = Chinese code

Digit 15 - Evaporator Application

F = Standard (40-60°F) leaving temp
G = Low (Less than 40°F) leaving temp
R = Remote (40-60°F) leaving temp

Digit 16 - Evaporator Configuration

N = 2 pass, 0.75" insulation
P = 3 pass, 0.75" insulation
Q = 2 pass, 1.25" insulation
R = 3 pass, 1.25" insulation

Digit 17 - Condenser Application

N = Standard ambient (25-115°F)
H = High ambient (25-125°F)
L = Low ambient (0-115°F)
W = Wide ambient (0-125°F)

Digit 18 - Condenser Fin Material

1 = Standard aluminum slit fins
2 = Copper fins
4 = CompleteCoat™ epoxy coated fins

Digit 19 - Condenser Fan/Motor Configuration

T = STD fans with TEAO motors
W = Low noise fans

Digit 20 - Compressor Motor Starter Type

X = Across-the-line
Y = Wye-delta closed transition

Digit 21 - Incoming Power Line Connection

1 = Single point power connection
2 = Dual point power connection

Digit 22 - Power Line Connection Type

T = Terminal block connection
D = Non-fused disconnect switch(es)
C = Circuit breaker(s)

Digit 23 - Unit Operator Interface

D = DynaView™ operator interface

Digit 24 - Remote Operator Interface

N = No remote interface
C = Tracer® Comm 3 interface
B = BACnet® interface
L = LonTalk® compatible (LCI-C) interface

Digit 25 - Control Input Accessories/Options

N = No remote inputs
R = Ext. evaporator leaving water setpoint
C = Ext. current limit setpoint
B = Ext. leaving water and current limit setpoint

Digit 26 - Control Output Accessories/Options

N = No output options
A = Alarm relay outputs
C = Ice making I/O
D = Alarm relay outputs and ice making I/O

Digit 27 - Electrical Protection Options

0 = No short circuit rating
5 = Default short circuit rating
6 = High amp short circuit rating

Digit 28 - Flow Switch

T = Factory installed flow switch, water
U = Factory installed flow switch, non-water fluids

Digit 29 - Control Panel Accessories

N = No convenience outlet
A = 15A 115V convenience outlet (60Hz)

Digit 30 - Service Valves

0 = No suction service valves
1 = With suction service valves

Digit 31 - Compressor Sound Attenuation Option

0 = No compressor sound attenuation
1 = Factory installed compressor sound attenuation

Digit 32 - Appearance Options

N = No appearance options
A = Architectural louvered panels
C = Half louvers

Digit 33 - Installation Accessories

N = No installation accessories
F = Flange kit for water connections
R = Neoprene in shear unit isolators
G = Neoprene isolators and flange kit
E = Seismic elastomeric isolation pads
S = Seismic spring isolators

Digit 34 - Factory Testing Options

0 = Standard functional test
C = Witness performance test with report
E = Performance test with report

Digit 35 - Control, Label & Literature

C = Spanish
E = English
F = French

Digit 36 - Special Order

X = Standard unit configuration
F = Ship to final finisher
S = Unit has special order feature

Digit 37 - Safety Devices

N = Standard



General Data

Table 1. 60 Hz standard efficiency — I-P

Size		140	155	170	185	200	225	250	275	300	350	400	450	500
Compressor		Screw												
Quantity	#	2	2	2	2	2	2	2	3	3	3	4	4	4
Nominal size @60Hz	(tons)	70/70	85/70	85/85	100/85	100/100	120/100	120/120	85-85/100	100-100/100	120-120/100	100-100/100-100	120-120/100-100	120-120/120-120
Evaporator		Flooded												
Water storage	(gal)	29	29	33	33	35	38	38	54	60	65	77	81	84
2 pass arrangement														
Min flow ^(a)	(gpm)	195	195	204	204	219	219	219	267	312	342	384	408	426
Max flow ^(a)	(gpm)	715	715	748	748	803	803	803	979	1144	1254	1408	1496	1562
Water connection	(NPS-in)	4	4	6	6	6	6	6	8	8	8	8	8	8
3 pass arrangement														
Min flow ^(a)	(gpm)	130	130	136	136	146	146	146	178	208	228	256	272	284
Max flow ^(a)	(gpm)	477	477	499	499	536	536	536	653	763	836	939	998	1042
Water connection	(NPS-in)	3.5	3.5	4	4	4	4	4	6	6	6	8	8	8
Condenser		Fin and tube												
Qty of coils	#	4	4	4	4	4	4	4	8	8	8	8	8	8
Coil length	(in)	156/156	180/156	180/180	216/180	216/216	252/216	252/252	180/108	216/108	252/108	216/216	252/216	252/252
Coil height	(in)	42	42	42	42	42	42	42	42	42	42	42	42	42
	(mm)	1067	1067	1067	1067	1067	1067	1067	1067	1067	1067	1067	1067	1067
# of rows	#	3	3	3	3	3	3	3	3	3	3	3	3	3
Fins per foot	(fpf)	192	192	192	192	192	192	192	192	192	192	192	192	192
Fan		Direct drive propeller												
Quantity	#	4/4	5/4	5/5	6/5	6/6	7/6	7/7	10/6	12/6	14/6	12/12	14/12	14/14
Diameter	(in)	30.0	30.0	30.0	30.0	30.0	30.0	30.0	30.0	30.0	30.0	30.0	30.0	30.0
Air flow per fan	(cfm)	9625	9394	9209	9209	9209	9210	9210	9209	9209	9208	9209	9210	9214
Power/motor	(hp)	1.5	1.5	1.5	1.5	1.5	1.5	1.5	1.5	1.5	1.5	1.5	1.5	1.5
Fan speed	(rpm)	1140	1140	1140	1140	1140	1140	1140	1140	1140	1140	1140	1140	1140
Tip speed	(Ft/min)	8954	8954	8954	8954	8954	8954	8954	8954	8954	8954	8954	8954	8954
General Unit		HFC-134a												
# Refrig ckts	#	2	2	2	2	2	2	2	2	2	2	2	2	2
% min load	%	15	15	15	15	15	15	15	15	15	15	15	15	15
Refrigerant charge	(lb)	165/165	175/165	175/175	215/210	215/215	225/215	225/225	365/200	415/200	460/200	415/415	460/415	460/460
Oil charge	(gal)	1.3/1.3	1.3/1.3	1.3/1.3	1.9/1.3	1.9/1.9	1.9/1.9	1.9/1.9	4.2/1.9	4.6/1.9	4.6/1.9	4.6/4.6	4.6/4.6	4.6/4.6
Min ambient-std	(°F)	25	25	25	25	25	25	25	25	25	25	25	25	25
Min ambient-low	(°F)	0	0	0	0	0	0	0	0	0	0	0	0	0

Notes:

1. Data containing information on two circuits is shown as follows: ckt 1/ ckt 2.
2. Minimum start-up/operating ambient is based on a 5 mph wind across the condenser.

(a) Minimum and maximum flow rates apply to constant-flow chilled water system running at AHRI conditions, without freeze inhibitors added to the water loop.

Table 2. 60 Hz high efficiency – I-P

Size		140	155	170	185	200	225	250	275	300	350	400
Compressor		Screw										
Quantity	#	2	2	2	2	2	2	2	3	3	4	4
Nominal size @60Hz	(tons)	70/70	85/70	85/85	100/85	100/100	120/100	120/120	85-85/100	100-100/100	85-85/85/85	100-100/100-100
Evaporator		Flooded										
Water storage	(gal)	33	33	35	38	38	38	38	65	65	77	84
2 pass arrangement												
Min flow ^(a)	(gpm)	204	204	219	219	219	219	219	342	342	384	426
Max flow ^(a)	(gpm)	748	748	803	803	803	803	803	1254	1254	1408	1562
Water connection	(NPS-in)	6	6	6	6	6	6	6	8	8	8	8
3 pass arrangement												
Min flow ^(a)	(gpm)	136	136	146	146	146	146	146	228	228	256	284
Max flow ^(a)	(gpm)	499	499	536	536	536	536	536	836	836	939	1042
Water connection	(NPS-in)	4	4	4	4	4	4	4	6	6	8	8
Condenser		Fin and tube										
Qty of coils	#	4	4	4	4	4	8	8	8	8	8	8
Coil length	(in)	180/180	216/180	216/216	252/216	252/252	144/144	144/144	216/144	252/144	216/216	252/252
Coil height	(in)	42	42	42	42	42	42	42	42	42	42	42
Number of rows	#	3	3	3	3	3	3	3	3	3	3	3
Fins per foot	(fpf)	192	192	192	192	192	192	192	192	192	192	192
Fan		Direct drive propeller										
Quantity	#	5/5	6/5	6/6	7/6	7/7	8/6	8/8	12/6	14/6	12/12	14/14
Diameter	(in)	30	30	30	30	30	30	30	30	30	30	30
Air flow/fan	(cfm)	9199	9199	9199	9200	9201	9783	9203	9652	9605	9199	9201
Power/motor	(hp)	1.5	1.5	1.5	1.5	1.5	1.5	1.5	1.5	1.5	1.5	1.5
Fan speed	(rpm)	1140	1140	1140	1140	1140	1140	1140	1140	1140	1140	1140
Tip speed	(Ft/Min)	8954	8954	8954	8954	8954	8954	8954	8954	8954	8954	8954
General Unit		HFC-134a										
# Refrig ckts	#	2	2	2	2	2	2	2	2	2	2	2
% min load	%	15	15	15	15	15	15	15	15	15	15	15
Refrigerant charge	(lb)	175/175	215/205	215/215	225/215	225/225	235/235	235/235	415/200	460/200	415/415	460/460
Oil charge	(gal)	1.3/1.3	1.3/1.3	1.3/1.3	1.9/1.3	1.9/1.9	1.9/1.9	1.9/1.9	2.1-2.1/1.9	2.3-2.3/1.9	2.1-2.1/2.1-2.1	2.3-2.3/2.3-2.3
Min ambient-std	(°F)	25	25	25	25	25	25	25	25	25	25	25
Min ambient-low	(°F)	0	0	0	0	0	0	0	0	0	0	0

Notes:

1. Data containing information on two circuits is shown as follows: ckt 1/ ckt 2.
2. Minimum start-up/operating ambient is based on a 5 mph wind across the condenser.

(a) Minimum and maximum flow rates apply to constant-flow chilled water system running at AHRI conditions, without freeze inhibitors added to the water loop.



General Data

Table 3. 60 Hz extra efficiency – I-P

Size		140	155	170	185	200	250	275	300	350
Compressor		Screw								
Quantity	#	2	2	2	2	2	3	3	4	4
Nominal size @60Hz	(tons)	70/70	85/70	85/85	100/85	100/100	70-70/85	85-85/85	70-70/70-70	85-85/85-85
Evaporator		Flooded								
Water storage	(gal)	35	33	38	38	38	65	65	71	84
2 pass arrangement										
Min flow ^(a)	(gpm)	219	204	219	219	219	342	342	384	426
Max flow ^(a)	(gpm)	803	748	803	803	803	1254	1254	1408	1562
Water connection	(NPS-in)	6	6	6	6	6	8	8	8	8
3 pass arrangement										
Min flow ^(a)	(gpm)	146	136	146	146	146	228	228	256	284
Max flow ^(a)	(gpm)	536	499	536	536	536	836	836	939	1042
Water connection	(NPS-in)	4	4	4	4	4	6	6	8	8
Condenser		Fin and tube								
Qty of coils	#	4	4	4	8	8	8	8	8	8
Coil length	(in)	216/216	252/216	252/252	144/144	144/144	216/144	252/144	216/216	252/252
Coil height	(in)	42	42	42	42	42	42	42	42	42
Number of rows	#	3	3	3	3	3	3	3	3	3
Fins per foot	(fpf)	192	192	192	192	192	192	192	192	192
Fan		Direct drive propeller								
Quantity	#	6/6	7/6	7/7	8/6	8/8	12/6	14/6	12/12	14/14
Diameter	(in)	30	30	30	30	30	30	30	30	30
Air flow/fan	(cfm)	9199	9200	9201	9783	9203	9652	9605	9199	9201
Power/motor	(hp)	1.5	1.5	1.5	1.5	1.5	1.5	1.5	1.5	1.5
Fan speed	(rpm)	1140	1140	1140	1140	1140	1140	1140	1140	1140
Tip speed	(Ft/Min)	8954	8954	8954	8954	8954	8954	8954	8954	8954
General Unit		HFC-134a								
# Refrig ckts	#	2	2	2	2	2	2	2	2	2
% min load	%	15	15	15	15	15	15	15	15	15
Refrigerant charge	(lb)	215/215	225/215	225/225	235/235	235/235	415/200	460/200	415/415	460/460
Oil charge	(gal)	1.3/1.3	1.9/1.3	1.9/1.9	1.9/1.9	1.9/1.9	2.1-2.1/1.9	2.1-2.1/1.9	2.1-2.1/2.1-2.1	2.1-2.1/2.1-2.1
Min ambient-std	(°F)	25	25	25	25	25	25	25	25	25
Min ambient-low	(°F)	0	0	0	0	0	0	0	0	0

Notes:

1. Data containing information on two circuits is shown as follows: ckt 1/ ckt 2.
2. Minimum start-up/operating ambient is based on a 5 mph wind across the condenser.

(a) Minimum and maximum flow rates apply to constant-flow chilled water system running at AHRI conditions, without freeze inhibitors added to the water loop.

Table 4. 60 Hz standard efficiency — SI

Size		140	155	170	185	200	225	250	275	300	350	400	450	500
Compressor		Screw												
Quantity	#	2	2	2	2	2	2	2	3	3	3	4	4	4
Nominal size (tons) @60Hz		70/70	85/70	85/85	100/85	100/100	120/100	120/120	85-85/100	100-100/100	120-120/100	100-100/100-100	120-120/100-100	120-120/120-120
Evaporator		Flooded												
Water storage	(L)	111	111	127	127	134	145	145	205	229	245	293	306	316
2 pass arrangement														
Min flow ^(a)	(L/s)	12	12	13	13	14	14	14	17	20	22	24	26	27
Max flow ^(a)	(L/s)	45	45	47	47	51	51	51	62	72	79	89	94	99
Water connection	(NPS-in)	4	4	6	6	6	6	6	8	8	8	8	8	8
3 pass arrangement														
Min flow ^(a)	(L/s)	8	8	9	9	9	9	9	11	13	14	16	17	18
Max flow ^(a)	(L/s)	30	30	31	31	34	34	34	41	48	53	59	63	66
Water connection	(NPS-in)	3.5	3.5	4	4	4	4	4	6	6	6	8	8	8
Condenser		Fin and tube												
Qty of coils	#	4	4	4	4	4	4	4	8	8	8	8	8	8
Coil length	(mm)	3962/3962	4572/3962	4572/4572	5486/4572	5486/5486	6400/5486	6400/5486	4572/2743	5486/2743	6400/2743	5486/5486	6400/5486	6400/6400
Coil height	(mm)	1067	1067	1067	1067	1067	1067	1067	1067	1067	1067	1067	1067	1067
# of rows	#	3	3	3	3	3	3	3	3	3	3	3	3	3
Fins per foot	(fpf)	192	192	192	192	192	192	192	192	192	192	192	192	192
Fan		Direct drive propeller												
Quantity	#	4/4	5/4	5/5	6/5	6/6	7/6	7/7	10/6	12/6	14/6	12/12	14/12	14/14
Diameter	(mm)	726.0	726.0	726.0	726.0	726.0	726.0	726.0	726.0	726.0	726.0	726.0	726.0	726.0
Air flow per fan	(m ³ /hr)	1635 ₁	15958	1564 ₄	15644	1564 ₄	1564 ₆	15647	15644	15645	15642	15645	15646	15653
Power/motor	(kW)	1.12	1.12	1.12	1.12	1.12	1.12	1.12	1.12	1.12	1.12	1.12	1.12	1.12
Fan speed	(rps)	19	19	19	19	19	19	19	19	19	19	19	19	19
Tip speed	M/S	45	45	45	45	45	45	45	45	45	45	45	45	45
General Unit		HFC-134a												
# Refrig ckts	#	2	2	2	2	2	2	2	2	2	2	2	2	2
% min load	%	15	15	15	15	15	15	15	15	15	15	15	15	15
Refrigerant charge	(kg)	75/75	79/75	79/79	98/95	98/98	102/98	102/102	166/91	188/91	209/91	188/188	209/188	209/209
Oil charge	(L)	5/5	5/5	5/5	7/5	7/7	7/7	7/7	8-8/7	9-9/7	9-9/11	9-9/9-9	9-9/9-9	9-9/9-9
Min ambient-std	(°C)	-3.9	-3.9	-3.9	-3.9	-3.9	-3.9	-3.9	-3.9	-3.9	-3.9	-3.9	-3.9	-3.9
Min ambient-low	(°C)	-17.8	-17.8	-17.8	-17.8	-17.8	-17.8	-17.8	-17.8	-17.8	-17.8	-17.8	-17.8	-17.8

Notes:

1. Data containing information on two circuits is shown as follows: ckt 1/ ckt 2.
2. Minimum start-up/operating ambient is based on a 5 mph wind across the condenser.

(a) Minimum and maximum flow rates apply to constant-flow chilled water system running at AHRI conditions, without freeze inhibitors added to the water loop.



General Data

Table 5. 60 Hz high efficiency – SI

Size		140	155	170	185	200	225	250	275	300	350	400
Compressor		Screw										
Quantity	#	2	2	2	2	2	2	2	3	3	4	4
Nominal size @60Hz	(tons)	70/70	85/70	85/85	100/85	100/100	120/100	120/120	85-85/100	100-100/100	85-85/85	100-100/100-100
Evaporator		Flooded										
Water storage	(L)	127	127	134	145	145	145	145	245	245	293	316
2 Pass arrangement												
Min flow ^(a)	(L/s)	13	13	14	14	14	14	14	22	22	24	27
Max flow ^(a)	(L/s)	47	47	51	51	51	51	51	79	79	89	99
Water connection	(NPS-in)	6	6	6	6	6	6	6	8	8	8	8
3 Pass arrangement												
Min flow ^(a)	(L/s)	9	9	9	9	9	9	9	14	14	16	18
Max flow ^(a)	(L/s)	31	31	34	34	34	34	34	53	53	59	66
Water connection	(NPS-in)	4	4	4	4	4	4	4	6	6	8	8
Condenser		Fin and tube										
Qty of coils	#	4	4	4	4	4	8	8	8	8	8	8
Coil length	(mm)	4572/4572	5486/4572	5486/5486	6400/5486	6400/6400	3657/3657	3657/3657	5486/3657	6400/3657	5486/5486	6400/6400
Coil height	(mm)	1067	1067	1067	1067	1067	1067	1067	1067	1067	1067	1067
Number of rows	#	3	3	3	3	3	3	3	3	3	3	3
Fins per foot	(fpf)	192	192	192	192	192	192	192	192	192	192	192
Fan		Direct drive propeller										
Quantity	#	5/5	6/5	6/6	7/6	7/7	8/6	8/8	12/6	14/6	12/12	14/14
Diameter	(mm)	762	762	762	762	762	762	762	762	762	762	762
Air per fan	(m ³ /hr)	15628	15628	15628	15629	15631	16619	15634	16397	16317	15628	15631
Power/motor	(kW)	1.12	1.12	1.12	1.12	1.12	1.12	1.12	1.12	1.12	1.12	1.12
Fan speed	(rps)	19	19	19	19	19	19	19	19	19	19	19
Tip speed	M/S	45	45	45	45	45	45	45	45	45	45	45
General Unit		HFC-134a										
# refrig ckts	#	2	2	2	2	2	2	2	2	2	2	2
% min load	%	15	15	15	15	15	15	15	15	15	15	15
Refrig charge	(kg)	79/79	98/93	98/98	102/98	102/102	107/107	107/107	188/91	209/91	188/188	209/209
Oil charge	(L)	5/5	5/5	5/5	7/5	7/7	7/7	7/7	8-8/7	9-9/7	8-8/8-8	9-9/9-9
Min ambient-std	(°C)	-3.9	-3.9	-3.9	-3.9	-3.9	-3.9	-3.9	-3.9	-3.9	-3.9	-3.9
Min ambient-low	(°C)	-17.8	-17.8	-17.8	-17.8	-17.8	-17.8	-17.8	-17.8	-17.8	-17.8	-17.8

Notes:

1. Data containing information on two circuits is shown as follows: ckt 1/ ckt 2.
2. Minimum start-up/operating ambient is based on a 5 mph wind across the condenser.

(a) Minimum and maximum flow rates apply to constant-flow chilled water system running at AHRI conditions, without freeze inhibitors added to the water loop.

Table 6. 60 Hz extra efficiency – SI

Size		140	155	170	185	200	250	275	300	350
Compressor										
Quantity	#	2	2	2	2	2	3	3	4	4
Nominal size @60Hz	(tons)	70/70	85/70	85/85	100/85	100/100	70-70/85	85-85/85	70-70/70-70	85-85/85-85
Evaporator										
						Flooded				
Water storage	(L)	133	125	145	145	145	245	245	270	316
2 Pass arrangement										
Min flow ^(a)	(L/s)	14	13	14	14	14	22	22	24	27
Max flow ^(a)	(L/s)	51	47	51	51	51	79	79	89	99
Water connection	(NPS-in)	6	6	6	6	6	8	8	8	8
3 Pass arrangement										
Min flow ^(a)	(L/s)	9	9	9	9	9	14	14	16	18
Max flow ^(a)	(L/s)	34	31	34	34	34	53	53	59	66
Water connection	(NPS-in)	4	4	4	4	4	6	6	8	8
Condenser										
						Fin and tube				
Qty of coils	#	4	4	4	8	8	8	8	8	8
Coil length	(mm)	5486/5486	6400/5486	6400/6400	3657/3657	4572/2743	5486/3657	6400/3657	5486/5486	6400/6400
Coil height	(mm)	1067	1067	1067	1067	1067	1067	1067	1067	1067
Number of rows	#	3	3	3	3	3	3	3	3	3
Fins per foot	(fpf)	192	192	192	192	192	192	192	192	192
Fan										
						Direct drive propeller				
Quantity	#	6/6	7/6	7/7	8/6	8/8	12/6	14/6	12/12	14/14
Diameter	(mm)	762	762	762	762	762	762	762	762	762
Air per fan	(m ³ /hr)	15628	15629	15631	16619	15634	16397	16317	15628	15631
Power/motor	(kW)	1.12	1.12	1.12	1.12	1.12	1.12	1.12	1.12	1.12
Fan speed	(rps)	19	19	19	19	19	19	19	19	19
Tip speed	M/S	45	45	45	45	45	45	45	45	45
General Unit										
						HFC-134a				
# refrigerant circuits	#	2	2	2	2	2	2	2	2	2
% min load	%	15	15	15	15	15	15	15	15	15
Refrigerant charge	(kg)	98/98	102/98	102/102	107/107	107/107	188/91	209/91	188/188	209/209
Oil charge	(L)	5/5	7/5	7/7	7/7	7/7	8-8/7	8-8/7	8-8/8-8	8-8/8-8
Min ambient-std	(°C)	-3.9	-3.9	-3.9	-3.9	-3.9	-3.9	-3.9	-3.9	-3.9
Min ambient-low	(°C)	-17.8	-17.8	-17.8	-17.8	-17.8	-17.8	-17.8	-17.8	-17.8

Notes:

1. Data containing information on two circuits is shown as follows: ckt 1/ ckt 2.
2. Minimum start-up/operating ambient is based on a 5 mph wind across the condenser.

(a) Minimum and maximum flow rates apply to constant-flow chilled water system running at AHRI conditions, without freeze inhibitors added to the water loop.



Controls

LCD Touch Screen Display

The standard DynaView™ display provided with the Tracer® CH530 control panel features an LCD touch screen that is navigated by file tabs. This is an advanced interface that allows the user to access any important information concerning setpoints, active temperatures, modes, electrical data, pressure, and diagnostics. It uses full text display available in 19 languages.

Display Features Include:

- LCD touch screen with LED backlighting, for scrolling access to input and output operating information
- Single screen, folder/tab style display of all available information on individual components (evaporator, condenser, compressor, etc.)
- Password entry/lockout system to enable or disable display
- Automatic and immediate stop capabilities for standard or immediate manual shutdown
- Fast, easy access to available chiller data in tabbed format, including:
 - Modes of operation, including normal cooling as well as ice making
 - Water temperatures and setpoints
 - Loading and limiting status and setpoints
 - Outdoor air temperature
 - Start/stop differential timers
 - Pump status and override
 - Chilled water reset settings
- Optional external setpoints, including:
 - Chilled water, demand limit, ice building

Reports, listed on a single tabbed screen for easy access, including:

- ASHRAE, containing all guideline 3 report information
- Evaporator, condenser, compressor

Evaporator, condenser, and compressor reports containing all operational information on individual components, including:

- Water temperatures, refrigerant pressures, temperatures, and approach
- Flow switch status, EXV position, compressor starts and run time

Alarm and diagnostic information, including:

- Flashing alarms with touch screen button for immediate address of alarm condition
- Scrollable list of last ten active diagnostics
- Specific information on applicable diagnostic from list of over one hundred
- Automatic or manual resetting diagnostic types

Adaptive Controls

Adaptive Controls directly sense the control variables that govern the operation of the chiller: evaporator pressure and condenser pressure. When any one of these variables approaches a limit condition when damage may occur to the unit or shutdown on a safety, Adaptive Controls takes corrective action to avoid shutdown and keep the chiller operating. This happens through combined actions of compressor and/or fan staging. Whenever possible, the chiller is allowed to continue making chilled water. This keeps cooling capacity available until the problem can be solved. Overall, the safety controls help keep the building or process running and out of trouble.

Integrated Rapid Restart

- Bringing a chiller back online rapidly after a loss of power is critical to operations in mission critical environments like data centers and hospitals which demand the highest levels of reliability.
- A loss of cooling capacity can be costly, which is why Trane chillers are designed and engineered for Rapid Restart. This not only helps the chiller get back online faster, but it also provides a simple and reliable solution to minimize the risks of financially devastating damage to assets caused by overheating due to a power loss.
- Of course, the truest test of a chiller's restart capabilities is the amount of time it takes to resume full-load cooling, and this is where the Trane chiller really shines. An 80 percent cooling load can be achieved in less than 2.5 minutes after power restoration—your assurance that the cooling capacity your equipment requires is just a few minutes away.

Stand Alone Controls

Single chillers installed in applications without a building management system is simple to install and control: only a remote auto/stop for scheduling is required for unit operation. Signals from the chilled water pump contactor auxiliary, or a flow switch, are wired to the chilled water flow interlock. Signals from a time clock or some other remote device are wired to the external auto/stop input.

- External Auto/Stop - A job site provided contact closure will turn the unit on and off.
- Chilled Water Flow Interlock - A job site provided contact closure from a chilled water pump contactor or a flow switch is required and will allow unit operation if a load exists. This feature will allow the unit to run in conjunction with the pump system.
- External Interlock - A job site supplied contact opening wired to this input will turn the unit off and require a manual reset of the unit microcomputer. This closure is typically triggered by a job site supplied system such as a fire alarm.
- Chilled Water Pump Control - Unit controls provide an output to control the chilled water pump(s). One contact closure to the chiller is all that is required to initiate the chilled water system. Chilled water pump control by the chiller is a requirement on the Air-Cooled Series R.
- Chilled Water Temperature Reset - The reset can be based on return water temperature or outdoor air temperature.

Hardwire Points

Microcomputer controls allow simple interface with other control systems, such as time clocks, building automation systems, and ice storage systems via hardwire points. This means you have the flexibility to meet job requirements while not having to learn a complicated control system.

Remote devices are wired from the control panel to provide auxiliary control to a building automation system. Inputs and outputs can be communicated via a typical 4–20 mA electrical signal, an equivalent 2–10 Vdc signal, or by utilizing contact closures. Contact closures may be used to trigger job site supplied alarm lights or alarm bells.

This setup has the same features as a stand alone water chiller, with the possibility of having additional optional features:

- Circuit enable/disable
- Ice making enable/status
- External chilled water setpoint, external demand limit setpoint
- Alarm indication contacts provides three single pole double throw contact closures to indicate: compressor on/off status, compressor running at maximum capacity, failure has occurred (ckt 1/ckt 2)

BACnet® Interface

BACnet® interface capabilities are available, with communication link via single twisted-pair wiring to a factory-installed and tested communication board.

Required features:

- BACnet® Interface (selectable option with chiller)

BACnet® is a data communication protocol for building automation and control networks developed by American Society of Heating, Refrigerating and Air-Conditioning Engineers (ASHRAE).

LonTalk® LCI-C Interface

LonTalk® (LCI-C) communications capabilities are available, with communication link via single twisted pair wiring to factory installed, tested communication board.

- Required features: LonTalk®/Tracer® Summit Interface (selectable option with chiller)

LonTalk® is a communications protocol developed by the Echelon™ Corporation. The LONMARK® association develops control profiles using the LonTalk communication protocol. LonTalk is a unit level communications protocol.

LonTalk® Communications Interface for Chillers (LCI-C) provides a generic automation system with the LONMARK® chiller profile inputs/outputs. In addition to the standard points, Trane provides other commonly used network output variables for greater interoperability with any automation system. The complete reference list of Trane LonTalk® points is available on the LONMARK® web site.

Trane controls or another vendor's system can use the predefined list of points with ease to give the operator a complete picture of how the system is running

Tracer Summit

The chiller plant control capabilities of the Trane Tracer® Summit building automation system are unequalled in the industry. Trane's depth of experience in chillers and controls makes us a well qualified choice for automation of chiller plants using air-cooled chillers. Our chiller plant automation software is fully pre-engineered and tested.

Required features:

- LonTalk®/Tracer® Summit Interface (selectable option with chiller)
- Building Control Unit (external device required)

Energy Efficiency

- Sequences starting of chillers to optimize the overall chiller plant energy efficiency
 - Individual chillers operate as base, peak, or swing based on capacity and efficiency
 - Automatically rotates individual chiller operation to equalize runtime and wear between chillers.
 - Evaluates and selects the lowest energy consumption alternative from an overall system perspective.

Easy Operation and Maintenance

- Remote monitoring and control
- Displays both current operation conditions and scheduled automated control actions
- Concise reports assist in planning for preventative maintenance and verifying performance
- Alarm notification and diagnostic messages aid in quick and accurate troubleshooting

Tracer SC

The Tracer® SC system controller acts as the central coordinator for all individual equipment devices on a Tracer building automation system. The Tracer® SC scans all unit controllers to update

information and coordinate building control, including building subsystems such as VAV and chiller water systems. With this system option, the full breadth of Trane's HVAC and controls experience are applied to offer solutions to many facility issues. The LAN allows building operators to manage these varied components as one system from any personal computer with web access. The benefits of this system are:

- Improved usability with automatic data collection, enhanced data logging, easier to create graphics, simpler navigation, pre-programmed scheduling, reporting, and alarm logs.
- Flexible technology allows for system sizes from 30-120 unit controllers with any combination of LonTalk® or BACnet® unit controllers.
- LEED certification through site commissioning report, energy data collection measurement, optimizing energy performance, and maintaining indoor air quality.
- Energy savings programs include: fan pressure optimization, ventilation reset, and chiller plant control (adds and subtracts chillers to meet cooling loads).

Electrical Data

Table 7. Standard efficiency — all ambient options

Unit Size	Rated Voltage (a)	# Power Conn(b)	# Comp	Fans			VFD Input	Cntrl kVA (c)	RLA(d)		XLRA((e)		YLRA(e)		MCA(f)		MOP(g)	
				Qty (Ckt1/Ckt2)	kw	FLA			Ckt 1	Ckt 2	Ckt 1	Ckt 2	Ckt 1	Ckt 2	Ckt 1	Ckt 2	Ckt 1	Ckt 2
140	200/60/3	1	2	8	1.5	5.4	5.6	0.83	270	270	1845	1845	600	600	655	800		
	200/60/3	2	2	4/4	1.5	5.4	5.6	0.83	270	270	1845	1845	600	600	363	359	600	600
	230/60/3	1	2	8	1.5	5.4	5.6	0.83	235	235	1556	1556	506	506	576	800		
	230/60/3	2	2	4/4	1.5	5.4	5.6	0.83	235	235	1556	1556	506	506	319	316	500	500
	380/60/3	1	2	8	1.5	3.3	3.3	0.83	142	142	976	976	316	316	349	450		
	380/60/3	2	2	4/4	1.5	3.3	3.3	0.83	142	142	976	976	316	316	193	191	300	300
	460/60/3	1	2	8	1.5	2.7	2.7	0.83	118	118	774	774	252	252	289	400		
	460/60/3	2	2	4/4	1.5	2.7	2.7	0.83	118	118	774	774	252	252	160	159	250	250
	575/60/3	1	2	8	1.5	2.2	2.2	0.83	94	94	631	631	205	205	231	300		
	575/60/3	2	2	4/4	1.5	2.2	2.2	0.83	94	94	631	631	205	205	128	127	200	200
155	200/60/3	1	2	9	1.5	5.4	5.6	0.83	320	270	2156	1845	701	600	723	1000		
	200/60/3	2	2	5/4	1.5	5.4	5.6	0.83	320	270	2156	1845	701	600	431	359	700	600
	230/60/3	1	2	9	1.5	5.4	5.6	0.83	278	235	1756	1556	571	506	635	800		
	230/60/3	2	2	5/4	1.5	5.4	5.6	0.83	278	235	1756	1556	571	506	378	316	600	500
	380/60/3	1	2	9	1.5	3.3	3.5	0.83	168	142	1060	973	345	316	384	500		
	380/60/3	2	2	5/4	1.5	3.3	3.5	0.83	168	142	1060	973	345	316	229	191	350	300
	460/60/3	1	2	9	1.5	2.7	2.9	0.83	139	118	878	774	285	252	318	450		
	460/60/3	2	2	5/4	1.5	2.7	2.9	0.83	139	118	878	774	285	252	189	159	300	250
	575/60/3	1	2	9	1.5	2.2	2.4	0.83	111	94	705	631	229	205	254	350		
	575/60/3	2	2	5/4	1.5	2.2	2.4	0.83	111	94	705	631	229	205	151	127	250	200

Table 7. Standard efficiency — all ambient options (continued)

Unit Size	Rated Voltage (a)	# Power Conn(b)	# Comp	Fans		VFD Input	Cntrl kVA (c)	RLA(d)		XLRA((e)		YLRA(e)		MCA(f)		MOP(g)	
				Qty (Ckt1/Ckt2)	kw			FLA	Ckt 1	Ckt 2	Ckt 1	Ckt 2	Ckt 1	Ckt 2	Ckt 1	Ckt 2	Ckt 1
170	200/60/3	1	2	10	1.5	5.4	5.6	0.83	320	320	2156	2156	701	701	779	700	1000
	200/60/3	2	2	5/5	1.5	5.4	5.6	0.83	320	320	2156	2156	701	701	431	427	700
	230/60/3	1	2	10	1.5	5.4	5.6	0.83	278	278	1756	1756	571	571	684	800	
	230/60/3	2	2	5/5	1.5	5.4	5.6	0.83	278	278	1756	1756	571	571	378	375	600
	380/60/3	1	2	10	1.5	3.3	3.5	0.83	168	168	1060	1060	345	345	414	500	
	380/60/3	2	2	5/5	1.5	3.3	3.5	0.83	168	168	1060	1060	345	345	229	227	350
	460/60/3	1	2	10	1.5	2.7	2.9	0.83	139	139	878	878	285	285	342	450	
	460/60/3	2	2	5/5	1.5	2.7	2.9	0.83	139	139	878	878	285	285	189	187	300
	575/60/3	1	2	10	1.5	2.2	2.4	0.83	111	111	705	705	229	229	274	350	
	575/60/3	2	2	5/5	1.5	2.2	2.4	0.83	111	111	705	705	229	229	151	150	250
185	200/60/3	1	2	11	1.5	5.4	5.6	0.83	386	320	2525	2156	821	701	866	1200	
	200/60/3	2	2	6/5	1.5	5.4	5.6	0.83	386	320	2525	2156	821	701	519	427	800
	230/60/3	1	2	11	1.5	5.4	5.6	0.83	336	278	2126	1756	691	571	761	1000	
	230/60/3	2	2	6/5	1.5	5.4	5.6	0.83	336	278	2126	1756	691	571	456	375	700
	380/60/3	1	2	11	1.5	3.3	3.5	0.83	203	169	1306	1060	424	345	461	600	
	380/60/3	2	2	6/5	1.5	3.3	3.5	0.83	203	169	1306	1060	424	345	276	227	450
	460/60/3	1	2	11	1.5	2.7	2.9	0.83	168	139	1065	878	346	285	381	500	
	460/60/3	2	2	6/5	1.5	2.7	2.9	0.83	168	139	1065	878	346	285	228	187	350
	575/60/3	1	2	11	1.5	2.2	2.4	0.83	134	111	853	705	277	229	305	400	
	575/60/3	2	2	6/5	1.5	2.2	2.4	0.83	134	111	853	705	277	229	182	150	300
200	200/60/3	1	2	12	1.5	5.4	5.6	0.83	386	386	2525	2525	821	821	938	1200	
	200/60/3	2	2	6/6	1.5	5.4	5.6	0.83	386	386	2525	2525	821	821	519	515	800
	230/60/3	1	2	12	1.5	5.4	5.6	0.83	336	336	2126	2126	691	691	825	1000	
	230/60/3	2	2	6/6	1.5	5.4	5.6	0.83	336	336	2126	2126	691	691	456	453	700
	380/60/3	1	2	12	1.5	3.3	3.5	0.83	203	203	1306	1306	424	424	499	700	
	380/60/3	2	2	6/6	1.5	3.3	3.5	0.83	203	203	1306	1306	424	424	276	274	450
	460/60/3	1	2	12	1.5	2.7	2.9	0.83	168	168	1065	1065	346	346	413	500	
	460/60/3	2	2	6/6	1.5	2.7	2.9	0.83	168	168	1065	1065	346	346	228	226	350
	575/60/3	1	2	12	1.5	2.2	2.4	0.83	134	134	853	853	277	277	330	450	
	575/60/3	2	2	6/6	1.5	2.2	2.4	0.83	134	134	853	853	277	277	182	181	300

Electrical Data

Table 7. Standard efficiency — all ambient options (continued)

Unit Size	Rated Voltage (a)	# Power Conn(b)	# Comp	Fans		VFD Input	Cntrl kVA (c)	RLA(d)		XLRA((e)		YLRA(e)		MCA(f)		MOP(g)	
				Qty (Ckt1/Ckt2)	kw			FLA	Ckt 1	Ckt 2	Ckt 1	Ckt 2	Ckt1	Ckt2	Ckt1	Ckt2	Ckt1
225	200/60/3	1	2	13	1.5	5.4	5.6	0.83	459	386	2525	821	821	1034	1200	800	
	200/60/3	2	2	7/6	1.5	5.4	5.6	0.83	459	386	2525	821	821	616	515	1000	800
	230/60/3	1	2	13	1.5	5.4	5.6	0.83	399	336	2126	691	691	909	1200		
	230/60/3	2	2	7/6	1.5	5.4	5.6	0.83	399	336	2126	691	691	540	453	800	700
	380/60/3	1	2	13	1.5	3.3	3.5	0.83	242	203	1306	424	424	551	700		
	380/60/3	2	2	7/6	1.5	3.3	3.5	0.83	242	203	1306	424	424	328	274	500	450
	460/60/3	1	2	13	1.5	2.7	2.9	0.83	200	168	1065	346	346	455	600		
	460/60/3	2	2	7/6	1.5	2.7	2.9	0.83	200	168	1065	346	346	271	226	450	350
	575/60/3	1	2	13	1.5	2.2	2.4	0.83	160	134	853	277	277	364	500		
	575/60/3	2	2	7/6	1.5	2.2	2.4	0.83	160	134	853	277	277	217	181	350	300
250	200/60/3	1	2	14	1.5	5.4	5.6	0.83	459	459	2525	821	821	113	1200		
	200/60/3	2	2	7/7	1.5	5.4	5.6	0.83	459	459	2525	821	821	616	612	1000	1000
	230/60/3	1	2	14	1.5	5.4	5.6	0.83	399	399	2126	691	691	977	1200		
	230/60/3	2	2	7/7	1.5	5.4	5.6	0.83	399	399	2126	691	691	540	537	800	800
	380/60/3	1	2	14	1.5	3.3	3.5	0.83	242	242	1306	424	424	593	800		
	380/60/3	2	2	7/7	1.5	3.3	3.5	0.83	242	242	1306	424	424	328	326	500	500
	460/60/3	1	2	14	1.5	2.7	2.9	0.83	200	200	1065	346	346	490	600		
	460/60/3	2	2	7/7	1.5	2.7	2.9	0.83	200	200	1065	346	346	271	269	450	450
	575/60/3	1	2	14	1.5	2.2	2.4	0.83	160	160	853	277	277	393	500		
	575/60/3	2	2	7/7	1.5	2.2	2.4	0.83	160	160	853	277	277	217	216	350	350
275	200/60/3	1	n/a	n/a	n/a	n/a	n/a	n/a	n/a	n/a	n/a	n/a	n/a	n/a	n/a	n/a	
	200/60/3	2	3	10/6	1.5	5.4	5.6	1.2	320-320	386	2156-2156	2525	701-701	779	519	1000	800
	230/60/3	1	n/a	n/a	n/a	n/a	n/a	n/a	n/a	n/a	n/a	n/a	n/a	n/a	n/a	n/a	
	230/60/3	2	3	10/6	1.5	5.4	5.6	1.2	278-278	336	1756-1756	2126	571-571	684	456	800	700
	380/60/3	1	n/a	n/a	n/a	n/a	n/a	n/a	n/a	n/a	n/a	n/a	n/a	n/a	n/a	n/a	
	380/60/3	2	3	10/6	1.5	3.3	3.5	1.2	168-168	203	1060-1060	1306	345-345	414	276	500	450
	460/60/3	1	3	16	1.5	2.7	2.9	1.2	139-139	168	878-878	1065	285-285	536	700		
	460/60/3	2	3	10/6	1.5	2.7	2.9	1.2	139-139	168	878-878	1065	285-285	342	228	450	350
	575/60/3	1	3	16	1.5	2.2	2.4	1.2	111-111	134	705-705	853	229-229	430	500		
	575/60/3	2	3	10/6	1.5	2.2	2.4	1.2	111-111	134	705-705	853	229-229	274	182	350	300

Table 7. Standard efficiency — all ambient options (continued)

Unit Size	Rated Voltage (a)	# Power Conn(b)	# Comp	Fans		VFD Input	Cntrl kVA (c)	RLA(d)		XLRA((e)		YLRA(e)		MCA(f)		MOP(g)	
				Qty (Ckt1/Ckt2)	kw			FLA	Ckt 1	Ckt 2	Ckt 1	Ckt 2	Ckt1	Ckt2	Ckt1	Ckt2	Ckt1
300	200/60/3	1	n/a	n/a	n/a	n/a	n/a	n/a	n/a	n/a	n/a	n/a	n/a	n/a	n/a	n/a	n/a
	200/60/3	2	3	12/6	1.5	5.4	5.6	386-386	386	2525-2525	2525	821-821	821	938	519	1200	800
	230/60/3	1	n/a	n/a	n/a	n/a	n/a	n/a	n/a	n/a	n/a	n/a	n/a	n/a	n/a	n/a	n/a
	230/60/3	2	3	12/6	1.5	5.4	5.6	336-336	336	2126-2126	2126	691-691	691	825	456	1000	700
	380/60/3	1	n/a	n/a	n/a	n/a	n/a	n/a	n/a	n/a	n/a	n/a	n/a	n/a	n/a	n/a	n/a
	380/60/3	2	3	12/6	1.5	3.3	3.5	203-203	203	1306-1306	1306	424-424	424	499	276	700	450
	460/60/3	1	3	18	1.5	2.7	2.9	168-168	168	1065-1065	1065	346-346	346	599		700	
	460/60/3	2	3	12/6	1.5	2.7	2.9	168-168	168	1065-1065	1065	346-346	346	413	228	500	350
	575/60/3	1	3	18	1.5	2.2	2.4	134-134	134	853-853	853	277-277	277	480		600	
	575/60/3	2	3	12/6	1.5	2.2	2.4	134-134	134	853-853	853	277-277	277	330	182	450	300
350	200/60/3	1	n/a	n/a	n/a	n/a	n/a	n/a	n/a	n/a	n/a	n/a	n/a	n/a	n/a	n/a	n/a
	200/60/3	2	3	14/6	1.5	5.4	5.6	459-459	386	2525-2525	2525	821-821	821	1113	519	1200	800
	230/60/3	1	n/a	n/a	n/a	n/a	n/a	n/a	n/a	n/a	n/a	n/a	n/a	n/a	n/a	n/a	n/a
	230/60/3	2	3	14/6	1.5	3.3	3.5	242-242	203	1306-1306	1306	424-424	424	593	276	800	450
	460/60/3	1	3	20	1.5	2.7	2.9	200-200	168	1065-1065	1065	346-346	346	677		800	
	460/60/3	2	3	14/6	1.5	2.7	2.9	200-200	168	1065-1065	1065	346-346	346	490	228	600	350
	575/60/3	1	3	20	1.5	2.2	2.4	160-160	134	853-853	853	277-277	277	543		700	
	575/60/3	2	3	14/6	1.5	2.2	2.4	160-160	134	853-853	853	277-277	277	393	182	500	300
	200/60/3	1	n/a	n/a	n/a	n/a	n/a	n/a	n/a	n/a	n/a	n/a	n/a	n/a	n/a	n/a	n/a
	200/60/3	2	4	12/12	1.5	5.4	5.6	386-386	386	2525-2525	2525-2525	821-821	821-821	938	938	1200	1200
400	230/60/3	1	n/a	n/a	n/a	n/a	n/a	n/a	n/a	n/a	n/a	n/a	n/a	n/a	n/a	n/a	n/a
	230/60/3	2	4	12/12	1.5	5.4	5.6	336-336	336	2126-2126	2126-2126	691-691	691-691	825	825	1000	1000
	380/60/3	1	n/a	n/a	n/a	n/a	n/a	n/a	n/a	n/a	n/a	n/a	n/a	n/a	n/a	n/a	n/a
	380/60/3	2	4	12/12	1.5	3.3	3.5	203-203	203	1306-1306	1306-1306	424-424	424-424	499	499	700	700
	460/60/3	1	4	24	1.5	2.7	2.9	168-168	168	1065-1065	1065-1065	346-346	346-346	784		800	
	460/60/3	2	4	12/12	1.5	2.7	2.9	168-168	168	1065-1065	1065-1065	346-346	346-346	413	413	500	500
	575/60/3	1	4	24	1.5	2.2	2.4	134-134	134	853-853	853-853	277-277	277-277	627		700	
	575/60/3	2	4	43446	1.5	2.2	2.4	134-134	134	853-853	853-853	277-277	277-277	330	330	450	450

Electrical Data

Table 7. Standard efficiency — all ambient options (continued)

Unit Size	Rated Voltage (a)	# Power Conn(b)	# Comp	Fans		VFD Input	Cntrl kVA (c)	RLA(d)		XLRA(e)		YLRA(e)		MCA(f)		MOP(g)		
				Qty (Ckt1/Ckt2)	kw			FLA	Ckt 1	Ckt 2	Ckt 1	Ckt 2	Ckt 1	Ckt 2	Ckt 1	Ckt 2	Ckt 1	Ckt 2
450	200/60/3	1	n/a	n/a	n/a	n/a	n/a	n/a	n/a	n/a	n/a	n/a	n/a	n/a	n/a	n/a	n/a	
	200/60/3	2	4	14/12	1.5	5.4	5.6	1.59	459-459	386-386	2525-2525	2525-2525	821-821	821-821	1113	938	1200	1200
	230/60/3	1	n/a	n/a	n/a	n/a	n/a	n/a	n/a	n/a	n/a	n/a	n/a	n/a	n/a	n/a	n/a	n/a
	230/60/3	2	4	14/12	1.5	5.4	5.6	1.59	399-399	336-336	2126-2126	2126-2126	691-691	691-691	977	825	1200	1000
	380/60/3	1	n/a	n/a	n/a	n/a	n/a	n/a	n/a	n/a	n/a	n/a	n/a	n/a	n/a	n/a	n/a	n/a
	380/60/3	2	4	14/12	1.5	3.3	3.5	1.59	242-242	203-203	1306-1306	1306-1306	424-424	424-424	593	499	800	700
	460/60/3	1	4	26	1.5	2.7	2.9	1.59	200-200	168-168	1065-1065	1065-1065	346-346	346-346	861		1000	
	460/60/3	2	4	14/12	1.5	2.7	2.9	1.59	200-200	168-168	1065-1065	1065-1065	346-346	346-346	490	413	600	500
	575/60/3	1	4	26	1.5	2.2	2.4	1.59	160-160	134-134	853-853	853-853	277-277	277-277	690		800	
	575/60/3	2	4	14/12	1.5	2.2	2.4	1.59	160-160	134-134	853-853	853-853	277-277	277-277	393	330	500	450
500	200/60/3	1	n/a	n/a	n/a	n/a	n/a	n/a	n/a	n/a	n/a	n/a	n/a	n/a	n/a	n/a	n/a	n/a
	200/60/3	2	4	14/14	1.5	5.4	5.6	1.59	459-459	459-459	2525-2525	2525-2525	821-821	821-821	1113	1113	1200	1200
	230/60/3	1	n/a	n/a	n/a	n/a	n/a	n/a	n/a	n/a	n/a	n/a	n/a	n/a	n/a	n/a	n/a	n/a
	230/60/3	2	4	14/14	1.5	5.4	5.6	1.59	399-399	399-399	2126-2126	2126-2126	691-691	691-691	977	977	1200	1200
	380/60/3	1	n/a	n/a	n/a	n/a	n/a	n/a	n/a	n/a	n/a	n/a	n/a	n/a	n/a	n/a	n/a	n/a
	380/60/3	2	4	14/14	1.5	3.3	3.5	1.59	242-242	242-242	1306-1306	1306-1306	424-424	424-424	593	593	800	800
	460/60/3	1	4	28	1.5	2.7	2.9	1.59	200-200	200-200	1065-1065	1065-1065	346-346	346-346	930		1000	
	460/60/3	2	4	14/14	1.5	2.7	2.9	1.59	200-200	200-200	1065-1065	1065-1065	346-346	346-346	490	490	600	600
	575/60/3	1	4	28	1.5	2.2	2.4	1.59	160-160	160-160	853-853	853-853	277-277	277-277	746		800	
	575/60/3	2	4	14/14	1.5	2.2	2.4	1.59	160-160	160-160	853-853	853-853	277-277	277-277	393	393	500	500

Notes:

- Local codes may take precedence.
 - All ambient means standard, low, high and wide ambient options.
- (a) Voltage Utilization Range: +/- 10% of rated voltage. Rated voltage (use range): 200/60/3 (180-220), 230/60/3 (208-254), 380/60/3 (342-418), 460/60/3 (414-506), 575/60/3 (516-633)
- (b) As standard, 140-250 ton units have a single point power connection. Optional dual point power connections are available. As standard, 275-500 ton units have dual point power connections. Optional single point power connections are available on 460V and 575V/60 Hz units.
- (c) Control VA includes operational controls only. It does not include evaporator heaters. A separate 115/60/1, 20 amp customer provided power connection is required to power the evaporator heaters (1640 watts).
- (d) RLA - Rated Load Amps
- (e) XLRA - Locked Rotor Amps - based on full winding (x-line) start units). YLRA for wye-delta starters is ~1/3 of LRA of x-line units.
- (f) MCA - Minimum Circuit Ampacity - 125 percent of largest compressor RLA plus 100 percent of all other loads.
- (g) Max fuse or MOP = 225 percent of the largest compressor RLA plus 100 percent of the second compressor RLA, plus the sum of the condenser fan FLA. (Use FLA per circuit, NOT FLA for the entire unit).

Table 8. High efficiency — standard and low ambient options

Unit Size	Rated Voltage(a)	# Power Conn(b)	# Comp	Fans			Cntrl kVA(c)	RLA(d)		XLRA(e)		YLRA(e)		MCA(f)		MOP(g)	
				Qty Ckt1/2	kw	FLA		Ckt1	Ckt2	Ckt1	Ckt2	Ckt1	Ckt2	Ckt1	Ckt2	Ckt1	Ckt2
140	200/60/3	1	2	10	1.5	5.4	5.6	0.83	259	259	1845	1845	600	600	641	800	800
	200/60/3	2	2	5/5	1.5	5.4	5.6	0.83	259	259	1845	1845	600	600	355	600	600
	230/60/3	1	2	10	1.5	5.4	5.6	0.83	225	225	1556	1556	506	506	564	700	700
	230/60/3	2	2	5/5	1.5	5.4	5.6	0.83	225	225	1556	1556	506	506	312	500	500
	380/60/3	1	2	10	1.5	3.3	3.3	0.83	136	136	973	973	316	316	342	450	450
	380/60/3	2	2	5/5	1.5	3.3	3.3	0.83	136	136	973	973	316	316	189	300	300
	460/60/3	1	2	10	1.5	2.7	2.7	0.83	113	113	774	774	252	252	283	350	350
	460/60/3	2	2	5/5	1.5	2.7	2.7	0.83	113	113	774	774	252	252	157	250	250
	575/60/3	1	2	10	1.5	2.2	2.2	0.83	90	90	631	631	205	205	226	300	300
	575/60/3	2	2	5/5	1.5	2.2	2.2	0.83	90	90	631	631	205	205	125	200	200
155	200/60/3	1	2	11	1.5	5.4	5.6	0.83	305	259	2156	1845	701	600	704	1000	1000
	200/60/3	2	2	6/5	1.5	5.4	5.6	0.83	305	259	2156	1845	701	600	418	700	600
	230/60/3	1	2	11	1.5	5.4	5.6	0.83	265	225	1756	1556	571	506	620	800	800
	230/60/3	2	2	6/5	1.5	5.4	5.6	0.83	265	225	1756	1556	571	506	367	600	500
	380/60/3	1	2	11	1.5	3.3	3.5	0.83	161	136	1060	973	345	316	376	500	500
	380/60/3	2	2	6/5	1.5	3.3	3.5	0.83	161	136	1060	973	345	316	223	350	300
	460/60/3	1	2	11	1.5	2.7	2.9	0.83	133	113	878	774	285	252	311	400	400
	460/60/3	2	2	6/5	1.5	2.7	2.9	0.83	133	113	878	774	285	252	184	300	250
	575/60/3	1	2	11	1.5	2.2	2.4	0.83	106	90	705	631	229	205	249	350	350
	575/60/3	2	2	6/5	1.5	2.2	2.4	0.83	106	90	705	631	229	205	147	250	200
170	200/60/3	1	2	12	1.5	5.4	5.6	0.83	305	305	2156	2156	701	701	756	1000	1000
	200/60/3	2	2	6/6	1.5	5.4	5.6	0.83	305	305	2156	2156	701	701	418	700	700
	230/60/3	1	2	12	1.5	5.4	5.6	0.83	265	265	1756	1756	571	571	665	800	800
	230/60/3	2	2	6/6	1.5	5.4	5.6	0.83	265	265	1756	1756	571	571	367	600	600
	380/60/3	1	2	12	1.5	3.3	3.5	0.83	161	161	1060	1060	345	345	404	500	500
	380/60/3	2	2	6/6	1.5	3.3	3.5	0.83	161	161	1060	1060	345	345	223	350	350
	460/60/3	1	2	12	1.5	2.7	2.9	0.83	133	133	878	878	285	285	334	450	450
	460/60/3	2	2	6/6	1.5	2.7	2.9	0.83	133	133	878	878	285	285	184	300	300
	575/60/3	1	2	12	1.5	2.2	2.4	0.83	106	106	705	705	229	229	267	350	350
	575/60/3	2	2	6/6	1.5	2.2	2.4	0.83	106	106	705	705	229	229	147	250	250

Electrical Data

Table 8. High efficiency — standard and low ambient options (continued)

Unit Size	Rated Voltage ^(a)	# Power Conn ^(b)	# Comp	Fans			Cntrl kVA ^(c)	RLA ^(d)		XLRA ^(e)		YLRA ^(e)		MCA ^(f)		MOP ^(g)		
				Qty Ckt1/2	kw	FLA		VFD Input	Ckt1	Ckt2	Ckt1	Ckt2	Ckt1	Ckt2	Ckt1	Ckt2	Ckt1	Ckt2
185	200/60/3	1	2	13	1.5	5.4	5.6	0.83	373	305	2525	2156	821	701	846	1200		
	200/60/3	2	2	7/6	1.5	5.4	5.6	0.83	373	305	2525	2156	821	701	508	414	800	700
	230/60/3	1	2	13	1.5	5.4	5.6	0.83	324	265	2126	1756	691	571	744	1000		
	230/60/3	2	2	7/6	1.5	5.4	5.6	0.83	324	265	2126	1756	691	571	447	364	700	600
	380/60/3	1	2	13	1.5	3.3	3.5	0.83	196	161	1306	1060	424	345	452	600		
	380/60/3	2	2	7/6	1.5	3.3	3.5	0.83	196	161	1306	1060	424	345	271	221	450	350
	460/60/3	1	2	13	1.5	2.7	2.9	0.83	162	133	1065	878	346	285	373	500		
	460/60/3	2	2	7/6	1.5	2.7	2.9	0.83	162	133	1065	878	346	285	223	183	350	300
	575/60/3	1	2	13	1.5	2.2	2.4	0.83	130	106	853	705	277	229	299	400		
	575/60/3	2	2	7/6	1.5	2.2	2.4	0.83	130	106	853	705	277	229	180	146	300	250
200	200/60/3	1	2	14	1.5	5.4	5.6	0.83	373	373	2525	2525	821	821	919	1200		
	200/60/3	2	2	7/7	1.5	5.4	5.6	0.83	373	373	2525	2525	821	821	508	504	800	800
	230/60/3	1	2	14	1.5	5.4	5.6	0.83	324	324	2126	2126	691	691	809	1000		
	230/60/3	2	2	7/7	1.5	5.4	5.6	0.83	324	324	2126	2126	691	691	447	443	700	700
	380/60/3	1	2	14	1.5	3.3	3.5	0.83	196	196	1306	1306	424	424	490	600		
	380/60/3	2	2	7/7	1.5	3.3	3.5	0.83	196	196	1306	1306	424	424	271	268	450	450
	460/60/3	1	2	14	1.5	2.7	2.9	0.83	162	162	1065	1065	346	346	405	500		
	460/60/3	2	2	7/7	1.5	2.7	2.9	0.83	162	162	1065	1065	346	346	223	222	350	350
	575/60/3	1	2	14	1.5	2.2	2.4	0.83	130	130	853	853	277	277	325	450		
	575/60/3	2	2	7/7	1.5	2.2	2.4	0.83	130	130	853	853	277	277	180	178	300	300
225	200/60/3	1	2	14	1.5	5.4	5.6	0.83	447	373	2525	2525	821	821	1012	1200		
	200/60/3	2	2	8/6	1.5	5.4	5.6	0.83	447	373	2525	2525	821	821	606	499	1000	800
	230/60/3	1	2	14	1.5	5.4	5.6	0.83	388	324	2126	2126	691	691	888	1200		
	230/60/3	2	2	8/6	1.5	5.4	5.6	0.83	388	324	2126	2126	691	691	532	438	800	700
	380/60/3	1	2	14	1.5	3.3	3.5	0.83	235	196	1306	1306	424	424	538	700		
	380/60/3	2	2	8/6	1.5	3.3	3.5	0.83	235	196	1306	1306	424	424	322	265	500	450
	460/60/3	1	2	14	1.5	2.7	2.9	0.83	194	162	1065	1065	346	346	444	600		
	460/60/3	2	2	8/6	1.5	2.7	2.9	0.83	194	162	1065	1065	346	346	266	219	450	350
	575/60/3	1	2	14	1.5	2.2	2.4	0.83	155	130	853	853	277	277	356	500		
	575/60/3	2	2	8/6	1.5	2.2	2.4	0.83	155	130	853	853	277	277	213	176	350	300

Table 8. High efficiency — standard and low ambient options (continued)

Unit Size	Rated Voltage ^(a)	# Power Conn ^(b)	# Comp	Fans			Cntrl kVA ^(c)	RLA ^(d)		XLRA ^(e)		YLRA ^(e)		MCA ^(f)		MOP ^(g)		
				Qty Ckt1/2	kw	FLA		VFD Input	Ckt1	Ckt2	Ckt1	Ckt2	Ckt1	Ckt2	Ckt1	Ckt2	Ckt1	Ckt2
250	200/60/3	1	2	16	1.5	5.4	5.6	0.83	447	447	2525	2525	821	821	1087	1200	1200	
	200/60/3	2	2	8/8	1.5	5.4	5.6	0.83	447	447	2525	2525	821	821	606	602	1000	1000
	230/60/3	1	2	16	1.5	5.4	5.6	0.83	388	388	2126	2126	691	691	963	1200	1200	
	230/60/3	2	2	8/8	1.5	5.4	5.6	0.83	388	388	2126	2126	691	691	532	528	800	800
	380/60/3	1	2	16	1.5	3.3	3.5	0.83	235	235	1306	1306	424	424	584	800	800	
	380/60/3	2	2	8/8	1.5	3.3	3.5	0.83	235	235	1306	1306	424	424	323	320	500	500
	460/60/3	1	2	16	1.5	2.7	2.9	0.83	194	194	1065	1065	346	346	482	600	600	
	460/60/3	2	2	8/8	1.5	2.7	2.9	0.83	194	194	1065	1065	346	346	267	264	450	450
	575/60/3	1	2	7/4	1.5	2.2	2.4	0.83	155	155	853	853	277	277	386	500	500	
	575/60/3	2	2	8/8	1.5	2.2	2.4	0.83	155	155	853	853	277	277	213	212	350	350
275	200/60/3	1	n/a	n/a	n/a	n/a	n/a	n/a	n/a	n/a	n/a	n/a	n/a	n/a	n/a	n/a	n/a	
	200/60/3	2	3	12/6	1.5	5.4	5.6	1.2	305-305	373	2156-2156	2525	701-701	821	756	503	1000	800
	230/60/3	1	n/a	n/a	n/a	n/a	n/a	n/a	n/a	n/a	n/a	n/a	n/a	n/a	n/a	n/a	n/a	
	230/60/3	2	3	12/6	1.5	5.4	5.6	1.2	265-265	324	1756-1756	2126	571-571	691	665	441	800	700
	380/60/3	1	n/a	n/a	n/a	n/a	n/a	n/a	n/a	n/a	n/a	n/a	n/a	n/a	n/a	n/a	n/a	
	380/60/3	2	3	12/6	1.5	3.3	3.5	1.2	161-161	196	1060-1060	1306	345-345	424	404	267	500	450
	460/60/3	1	3	18	1.5	2.7	2.9	1.2	133-133	162	878-878	1065	285-285	346	522	600	600	
	460/60/3	2	3	12/6	1.5	2.7	2.9	1.2	133-133	162	878-878	1065	285-285	346	334	221	450	350
	575/60/3	1	3	18	1.5	2.2	2.4	1.2	106-106	130	705-705	853	229-229	277	419	500	500	
	575/60/3	2	3	12/6	1.5	2.2	2.4	1.2	106-106	130	705-705	853	229-229	277	267	177	350	300
300	200/60/3	1	n/a	n/a	n/a	n/a	n/a	n/a	n/a	n/a	n/a	n/a	n/a	n/a	n/a	n/a	n/a	
	200/60/3	2	3	14/6	1.5	5.4	5.6	1.2	373-373	373	2525-2525	2525	821-821	821	919	503	1200	800
	230/60/3	1	n/a	n/a	n/a	n/a	n/a	n/a	n/a	n/a	n/a	n/a	n/a	n/a	n/a	n/a	n/a	
	230/60/3	2	3	14/6	1.5	5.4	5.6	1.2	324-324	324	2126-2126	2126	691-691	691	809	441	1000	700
	380/60/3	1	n/a	n/a	n/a	n/a	n/a	n/a	n/a	n/a	n/a	n/a	n/a	n/a	n/a	n/a	n/a	
	380/60/3	2	3	14/6	1.5	3.3	3.5	1.2	196-196	196	1306-1306	1306	424-424	424	490	267	600	450
	460/60/3	1	3	20	1.5	2.7	2.9	1.2	162-162	162	1065-1065	1065	346-346	346	585	700	700	
	460/60/3	2	3	14/6	1.5	2.7	2.9	1.2	162-162	162	1065-1065	1065	346-346	346	405	221	500	350
	575/60/3	1	3	20	1.5	2.2	2.4	1.2	130-130	130	853-853	853	277-277	277	470	600	600	
	575/60/3	2	3	14/6	1.5	2.2	2.4	1.2	130-130	130	853-853	853	277-277	277	325	177	450	300

Electrical Data

Table 8. High efficiency — standard and low ambient options (continued)

Unit Size	Rated Voltage ^(a)	# Power Conn ^(b)	# Comp	Fans			Cntrl kVA ^(c)	RLA ^(d)		XLRA ^(e)		YLRA ^(e)		MCA ^(f)		MOP ^(g)	
				Qty Ckt1/2	kw	FLA		VFD Input	Ckt1	Ckt2	Ckt1	Ckt2	Ckt1	Ckt2	Ckt1	Ckt2	Ckt1
350	200/60/3	1	n/a	n/a	n/a	n/a	n/a	n/a	n/a	n/a	n/a	n/a	n/a	n/a	n/a	n/a	n/a
	200/60/3	2	4	12/12	1.5	5.4	5.6	305-305	305-305	2156-2156	701-701	701-701	756	756	1000	1000	
	230/60/3	1	n/a	n/a	n/a	n/a	n/a	n/a	n/a	n/a	n/a	n/a	n/a	n/a	n/a	n/a	n/a
	230/60/3	2	4	12/12	1.5	5.4	5.6	265-265	265-265	1756-1756	571-571	571-571	665	665	800	800	
	380/60/3	1	n/a	n/a	n/a	n/a	n/a	n/a	n/a	n/a	n/a	n/a	n/a	n/a	n/a	n/a	n/a
	380/60/3	2	4	12/12	1.5	3.3	3.5	161-161	161-161	1060-1060	345-345	345-345	404	404	500	500	
	460/60/3	1	4	24	1.5	2.7	2.9	133-133	133-133	878-878	285-285	285-285	634	634	700	700	
	460/60/3	2	4	12/12	1.5	2.7	2.9	133-133	133-133	878-878	285-285	285-285	334	334	450	450	
	575/60/3	1	4	24	1.5	2.2	2.4	106-106	106-106	705-705	229-229	229-229	507	507	600	600	
	575/60/3	2	4	12/12	1.5	2.2	2.4	106-106	106-106	705-705	229-229	229-229	267	267	350	350	
400	200/60/3	1	n/a	n/a	n/a	n/a	n/a	n/a	n/a	n/a	n/a	n/a	n/a	n/a	n/a	n/a	n/a
	200/60/3	2	4	14/14	1.5	5.4	5.6	373-373	373-373	2525-2525	821-821	821-821	919	919	1200	1200	
	230/60/3	1	n/a	n/a	n/a	n/a	n/a	n/a	n/a	n/a	n/a	n/a	n/a	n/a	n/a	n/a	n/a
	230/60/3	2	4	14/14	1.5	5.4	5.6	324-324	324-324	2126-2126	691-691	691-691	809	809	1000	1000	
	380/60/3	1	n/a	n/a	n/a	n/a	n/a	n/a	n/a	n/a	n/a	n/a	n/a	n/a	n/a	n/a	n/a
	380/60/3	2	4	14/14	1.5	3.3	3.5	196-196	196-196	1306-1306	424-424	424-424	490	490	600	600	
	460/60/3	1	4	28	1.5	2.7	2.9	162-162	162-162	1065-1065	346-346	346-346	769	769	800	800	
	460/60/3	2	4	14/14	1.5	2.7	2.9	162-162	162-162	1065-1065	346-346	346-346	405	405	500	500	
	575/60/3	1	4	28	1.5	2.2	2.4	130-130	130-130	853-853	277-277	277-277	618	618	700	700	
	575/60/3	2	4	14/14	1.5	2.2	2.4	130-130	130-130	853-853	277-277	277-277	325	325	450	450	

Note: Local codes may take precedence.

- (a) Voltage Utilization Range: +/- 10% of rated voltage. Rated voltage (use range): 200/60/3 (180-220), 230/60/3 (208-254), 380/60/3 (342-418), 460/60/3 (414-506), 575/60/3 (516-633)
- (b) As standard, 140-250 ton units have a single point power connection. Optional dual point power connections are available. As standard, 275-500 ton units have dual point power connections. Optional single point power connections are available on 460V and 575V/60 Hz units.
- (c) Control VA includes operational controls only. It does not include evaporator heaters. A separate 115/60/1, 20 amp customer provided power connection is required to power the evaporator heaters (1640 watts).
- (d) RLA - Rated Load Amps
- (e) XLRA - Locked Rotor Amps - based on full winding (x-line) start units). YLRA for wye-delta starters is ~1/3 of LRA of x-line units.
- (f) MCA - Minimum Circuit Ampacity - 125 percent of largest compressor RLA plus 100 percent of all other loads.
- (g) Max fuse or MOP = 225 percent of the largest compressor RLA plus 100 percent of the second compressor RLA, plus the sum of the condenser fan FLA. (Use FLA per circuit, NOT FLA for the entire unit).

Table 9. High efficiency — high and wide ambient options

Unit Size	Rated Voltage(a)	# Power Conn(b)	# Comp	Fans			Cntrl kVA(c)	RLA(d)		XLRA(e)		YLRA(e)		MCA(f)		MOP(g)	
				Qty Ckt1/2	kw	FLA		Ckt1	Ckt2	Ckt1	Ckt2	Ckt1	Ckt2	Ckt1	Ckt2	Ckt1	Ckt2
140	200/60/3	1	2	10	1.5	5.4	5.6	0.83	270	270	1845	1845	600	600	666	800	800
	200/60/3	2	2	5/5	1.5	5.4	5.6	0.83	270	270	1845	1845	600	600	369	600	600
	230/60/3	1	2	10	1.5	5.4	5.6	0.83	235	235	1556	1556	506	506	587	800	800
	230/60/3	2	2	5/5	1.5	5.4	5.6	0.83	235	235	1556	1556	506	506	325	500	500
	380/60/3	1	2	10	1.5	3.3	3.3	0.83	142	142	973	973	316	316	355	450	450
	380/60/3	2	2	5/5	1.5	3.3	3.3	0.83	142	142	973	973	316	316	196	300	300
	460/60/3	1	2	10	1.5	2.7	2.7	0.83	118	118	774	774	252	252	295	400	400
	460/60/3	2	2	5/5	1.5	2.7	2.7	0.83	118	118	774	774	252	252	163	250	250
	575/60/3	1	2	10	1.5	2.2	2.2	0.83	94	94	631	631	205	205	235	300	300
	575/60/3	2	2	5/5	1.5	2.2	2.2	0.83	94	94	631	631	205	205	130	200	200
155	200/60/3	1	2	11	1.5	5.4	5.6	0.83	320	270	2156	1845	701	600	734	1000	1000
	200/60/3	2	2	6/5	1.5	5.4	5.6	0.83	320	270	2156	1845	701	600	437	700	600
	230/60/3	1	2	11	1.5	5.4	5.6	0.83	278	235	1756	1556	571	506	646	800	800
	230/60/3	2	2	6/5	1.5	5.4	5.6	0.83	278	235	1756	1556	571	506	384	600	500
	380/60/3	1	2	11	1.5	3.3	3.5	0.83	168	142	1060	973	345	316	391	500	500
	380/60/3	2	2	6/5	1.5	3.3	3.5	0.83	168	142	1060	973	345	316	232	400	300
	460/60/3	1	2	11	1.5	2.7	2.9	0.83	139	118	878	774	285	252	324	450	450
	460/60/3	2	2	6/5	1.5	2.7	2.9	0.83	139	118	878	774	285	252	192	300	250
	575/60/3	1	2	11	1.5	2.2	2.4	0.83	111	94	705	631	229	205	259	350	350
	575/60/3	2	2	6/5	1.5	2.2	2.4	0.83	111	94	705	631	229	205	154	250	200
170	200/60/3	1	2	12	1.5	5.4	5.6	0.83	320	320	2156	2156	701	701	789	1000	1000
	200/60/3	2	2	6/6	1.5	5.4	5.6	0.83	320	320	2156	2156	701	701	437	700	700
	230/60/3	1	2	12	1.5	5.4	5.6	0.83	278	278	1756	1756	571	571	694	800	800
	230/60/3	2	2	6/6	1.5	5.4	5.6	0.83	278	278	1756	1756	571	571	384	600	600
	380/60/3	1	2	12	1.5	3.3	3.5	0.83	168	168	1060	1060	345	345	420	500	500
	380/60/3	2	2	6/6	1.5	3.3	3.5	0.83	168	168	1060	1060	345	345	232	400	350
	460/60/3	1	2	12	1.5	2.7	2.9	0.83	139	139	878	878	285	285	347	450	450
	460/60/3	2	2	6/6	1.5	2.7	2.9	0.83	139	139	878	878	285	285	192	300	300
	575/60/3	1	2	12	1.5	2.2	2.4	0.83	111	111	705	705	229	229	278	350	350
	575/60/3	2	2	6/6	1.5	2.2	2.4	0.83	111	111	705	705	229	229	154	250	250

Electrical Data

Table 9. High efficiency — high and wide ambient options (continued)

Unit Size	Rated Voltage ^(a)	# Power Conn ^(b)	# Comp	Fans			Cntrl kVA ^(c)	RLA ^(d)		XLRA ^(e)		YLRA ^(e)		MCA ^(f)		MOP ^(g)		
				Qty Ckt1/2	kw	FLA		VFD Input	Ckt1	Ckt2	Ckt1	Ckt2	Ckt1	Ckt2	Ckt1	Ckt2	Ckt1	Ckt2
185	200/60/3	1	2	13	1.5	5.4	5.6	0.83	386	320	2525	2156	821	701	877	1200		
	200/60/3	2	2	7/6	1.5	5.4	5.6	0.83	386	320	2525	2156	821	701	525	433	800	700
	230/60/3	1	2	13	1.5	5.4	5.6	0.83	336	278	2126	1756	691	571	772	1000		
	230/60/3	2	2	7/6	1.5	5.4	5.6	0.83	336	278	2126	1756	691	571	462	380	700	600
	380/60/3	1	2	13	1.5	3.3	3.5	0.83	203	168	1306	1060	424	345	467	600		
	380/60/3	2	2	7/6	1.5	3.3	3.5	0.83	203	168	1306	60	424	345	279	230	450	350
	460/60/3	1	2	13	1.5	2.7	2.9	0.83	168	139	1065	878	346	285	386	500		
	460/60/3	2	2	7/6	1.5	2.7	2.9	0.83	168	139	1065	878	346	285	231	190	350	300
	575/60/3	1	2	13	1.5	2.2	2.4	0.83	134	111	853	705	277	229	309	450		
	575/60/3	2	2	7/6	1.5	2.2	2.4	0.83	134	111	853	705	277	229	185	152	300	250
200	200/60/3	1	2	14	1.5	5.4	5.6	0.83	386	386	2525	2525	821	821	949	1200		
	200/60/3	2	2	7/7	1.5	5.4	5.6	0.83	386	386	2525	2525	821	821	525	521	800	800
	230/60/3	1	2	14	1.5	5.4	5.6	0.83	336	336	2126	2126	691	691	836	1000		
	230/60/3	2	2	7/7	1.5	5.4	5.6	0.83	336	336	2126	2126	691	691	462	458	700	700
	380/60/3	1	2	14	1.5	3.3	3.5	0.83	203	203	1306	1306	424	424	506	700		
	380/60/3	2	2	7/7	1.5	3.3	3.5	0.83	203	203	1306	1306	424	424	279	277	450	450
	460/60/3	1	2	14	1.5	2.7	2.9	0.83	168	168	1065	1065	346	346	418	500		
	460/60/3	2	2	7/7	1.5	2.7	2.9	0.83	168	168	1065	1065	346	346	231	229	350	350
	575/60/3	1	2	14	1.5	2.2	2.4	0.83	134	134	853	853	277	277	334	450		
	575/60/3	2	2	7/7	1.5	2.2	2.4	0.83	134	134	853	853	277	277	185	183	300	300
225	200/60/3	1	2	14	1.5	5.4	5.6	0.83	459	386	2525	2525	821	821	1040	1200		
	200/60/3	2	2	8/6	1.5	5.4	5.6	0.83	459	386	2525	2525	821	821	621	515	1000	800
	230/60/3	1	2	14	1.5	5.4	5.6	0.83	399	336	2126	2126	691	691	914	1200		
	230/60/3	2	2	8/6	1.5	5.4	5.6	0.83	399	336	2126	2126	691	691	546	453	800	700
	380/60/3	1	2	14	1.5	3.3	3.5	0.83	242	203	1306	1306	424	424	554	700		
	380/60/3	2	2	8/6	1.5	3.3	3.5	0.83	242	203	1306	1306	424	424	331	274	500	450
	460/60/3	1	2	14	1.5	2.7	2.9	0.83	200	168	1065	1065	346	346	458	600		
	460/60/3	2	2	8/6	1.5	2.7	2.9	0.83	200	168	1065	1065	346	346	274	226	450	350
	575/60/3	1	2	14	1.5	2.2	2.4	0.83	160	134	853	853	277	277	367	500		
	575/60/3	2	2	8/6	1.5	2.2	2.4	0.83	160	134	853	853	277	277	219	181	350	300

Table 9. High efficiency — high and wide ambient options (continued)

Unit Size	Rated Voltage ^(a)	# Power Conn ^(b)	# Comp	Fans			Cntrl kVA ^(c)	RLA ^(d)		XLRA ^(e)		YLRA ^(e)		MCA ^(f)		MOP ^(g)		
				Qty Ckt1/2	kw	FLA		VFD Input	Ckt1	Ckt2	Ckt1	Ckt2	Ckt1	Ckt2	Ckt1	Ckt2	Ckt1	Ckt2
250	200/60/3	1	2	16	1.5	5.4	5.6	0.83	459	459	2525	2525	821	821	1124	1124	1200	1200
	200/60/3	2	2	8/8	1.5	5.4	5.6	0.83	459	459	2525	2525	821	821	621	617	1000	1000
	230/60/3	1	2	16	1.5	5.4	5.6	0.83	399	399	2126	2126	691	691	988	988	1200	1200
	230/60/3	2	2	8/8	1.5	5.4	5.6	0.83	399	399	2126	2126	691	691	546	542	800	800
	380/60/3	1	2	16	1.5	3.3	3.5	0.83	242	242	1306	1306	424	424	600	600	800	800
	380/60/3	2	2	8/8	1.5	3.3	3.5	0.83	242	242	1306	1306	424	424	331	329	500	500
	460/60/3	1	2	16	1.5	2.7	2.9	0.83	200	200	1065	1065	346	346	495	495	700	700
	460/60/3	2	2	8/8	1.5	2.7	2.9	0.83	200	200	1065	1065	346	346	274	272	450	450
	575/60/3	1	2	16	1.5	2.2	2.4	0.83	160	160	853	853	277	277	397	397	500	500
	575/60/3	2	2	8/8	1.5	2.2	2.4	0.83	160	160	853	853	277	277	219	218	350	350
275	200/60/3	1	n/a	n/a	n/a	n/a	n/a	n/a	n/a	n/a	n/a	n/a	n/a	n/a	n/a	n/a	n/a	n/a
	200/60/3	2	3	12/6	1.5	5.4	5.6	1.2	320-320	386	2156-2156	2525	701-701	821	789	519	1000	800
	230/60/3	1	n/a	n/a	n/a	n/a	n/a	n/a	n/a	n/a	n/a	n/a	n/a	n/a	n/a	n/a	n/a	n/a
	230/60/3	2	3	12/6	1.5	5.4	5.6	1.2	278-278	336	1756-1756	2126	571-571	691	694	456	800	700
	380/60/3	1	n/a	n/a	n/a	n/a	n/a	n/a	n/a	n/a	n/a	n/a	n/a	n/a	n/a	n/a	n/a	n/a
	380/60/3	2	3	12/6	1.5	3.5	3.5	1.2	168-168	203	1060-1060	1306	345-345	424	420	276	500	450
	460/60/3	1	3	18	1.5	3	2.9	1.2	139-139	168	878-878	1065	285-285	346	541	700	700	700
	460/60/3	2	3	12/6	1.5	3	2.9	1.2	139-139	168	878-878	1065	285-285	346	347	228	450	350
	575/60/3	1	3	18	1.5	2.5	2.4	1.2	111-111	134	705-705	853	229-229	277	434	500	500	500
	575/60/3	2	3	12/6	1.5	2.5	2.4	1.2	111-111	134	705-705	853	229-229	277	278	182	350	300
300	200/60/3	1	n/a	n/a	n/a	n/a	n/a	n/a	n/a	n/a	n/a	n/a	n/a	n/a	n/a	n/a	n/a	n/a
	200/60/3	2	3	14/6	1.5	5.4	5.6	1.2	386-386	386	2525-2525	2525	821-821	821	949	519	1200	800
	230/60/3	1	n/a	n/a	n/a	n/a	n/a	n/a	n/a	n/a	n/a	n/a	n/a	n/a	n/a	n/a	n/a	n/a
	230/60/3	2	3	14/6	1.5	5.4	5.6	1.2	336-336	336	2126-2126	2126	691-691	691	836	456	1000	700
	380/60/3	1	n/a	n/a	n/a	n/a	n/a	n/a	n/a	n/a	n/a	n/a	n/a	n/a	n/a	n/a	n/a	n/a
	380/60/3	2	3	14/6	1.5	3.3	3.5	1.2	203-203	203	1306-1306	1306	424-424	424	506	276	700	450
	460/60/3	1	3	20	1.5	2.7	2.9	1.2	168-168	168	1065-1065	1065	346-346	346	604	700	700	700
	460/60/3	2	3	14/6	1.5	2.7	2.9	1.2	168-168	168	1065-1065	1065	346-346	346	418	228	500	350
	575/60/3	1	3	20	1.5	2.2	2.4	1.2	134-134	134	853-853	853	277-277	277	483	600	600	600
	575/60/3	2	3	14/6	1.5	2.2	2.4	1.2	134-134	134	853-853	853	277-277	277	334	182	450	300

Electrical Data

Table 9. High efficiency — high and wide ambient options (continued)

Unit Size	Rated Voltage ^(a)	# Power Conn ^(b)	# Comp	Fans			Cntrl kVA ^(c)	RLA ^(d)		XLRA ^(e)		YLRA ^(e)		MCA ^(f)		MOP ^(g)		
				Qty Ckt1/2	kw	FLA		VFD Input	Ckt1	Ckt2	Ckt1	Ckt2	Ckt1	Ckt2	Ckt1	Ckt2	Ckt1	Ckt2
350	200/60/3	1	n/a	n/a	n/a	n/a	n/a	n/a	n/a	n/a	n/a	n/a	n/a	n/a	n/a	n/a	n/a	
	200/60/3	2	4	12/12	1.5	5.4	5.6	320-320	2156-2156	2156-2156	701-701	701-701	789	789	1000	1000	1000	
	230/60/3	1	n/a	n/a	n/a	n/a	n/a	n/a	n/a	n/a	n/a	n/a	n/a	n/a	n/a	n/a	n/a	
	230/60/3	2	4	12/12	1.5	5.4	5.6	278-278	1756-1756	1756-1756	571-571	571-571	694	694	800	800	800	
	380/60/3	1	n/a	n/a	n/a	n/a	n/a	n/a	n/a	n/a	n/a	n/a	n/a	n/a	n/a	n/a	n/a	
	380/60/3	2	4	12/12	1.5	3.3	3.5	168-168	1060-1060	1060-1060	345-345	345-345	420	420	500	500	500	
	460/60/3	1	4	24	1.5	2.7	2.9	139-139	878-878	878-878	285-285	285-285	660	660	700	700	700	
	460/60/3	2	4	12/12	1.5	2.7	2.9	139-139	878-878	878-878	285-285	285-285	347	347	450	450	450	
	575/60/3	1	4	24	1.5	2.2	2.4	111-111	705-705	705-705	229-229	229-229	528	528	600	600	600	
	575/60/3	2	4	12/12	1.5	2.2	2.4	111-111	705-705	705-705	229-229	229-229	278	278	350	350	350	
400	200/60/3	1	n/a	n/a	n/a	n/a	n/a	n/a	n/a	n/a	n/a	n/a	n/a	n/a	n/a	n/a	n/a	
	200/60/3	2	4	14/14	1.5	5.4	5.6	386-386	2525-2525	2525-2525	821-821	821-821	949	949	1200	1200	1200	
	230/60/3	1	n/a	n/a	n/a	n/a	n/a	n/a	n/a	n/a	n/a	n/a	n/a	n/a	n/a	n/a	n/a	
	230/60/3	2	4	14/14	1.5	5.4	5.6	336-336	2126-2126	2126-2126	691-691	691-691	836	836	1000	1000	1000	
	200/60/3	1	n/a	n/a	n/a	n/a	n/a	n/a	n/a	n/a	n/a	n/a	n/a	n/a	n/a	n/a	n/a	
	380/60/3	2	4	14/14	1.5	3.3	3.5	203-203	1306-1306	1306-1306	424-424	424-424	506	506	700	700	700	
	460/60/3	1	4	28	1.5	2.7	2.9	168-168	1065-1065	1065-1065	346-346	346-346	794	794	800	800	800	
	460/60/3	2	4	14/14	1.5	2.7	2.9	168-168	1065-1065	1065-1065	346-346	346-346	418	418	500	500	500	
	575/60/3	1	4	28	1.5	2.2	2.4	134-134	853-853	853-853	277-277	277-277	635	635	700	700	700	
	575/60/3	2	4	14/14	1.5	2.2	2.4	134-134	853-853	853-853	277-277	277-277	334	334	450	450	450	

Note: Local codes may take precedence.

- (a) Voltage Utilization Range: +/- 10% of rated voltage. Rated voltage (use range): 200/60/3 (180-220), 230/60/3 (208-254), 380/60/3 (342-418), 460/60/3 (414-506), 575/60/3 (516-633)
- (b) As standard, 140-250 ton units have a single point power connection. Optional dual point power connections are available. As standard, 275-500 ton units have dual point power connections. Optional single point power connections are available on 460V and 575V/60 Hz units.
- (c) Control VA includes operational controls only. It does not include evaporator heaters. A separate 115/60/1, 20 amp customer provided power connection is required to power the evaporator heaters (1640 watts).
- (d) RLA - Rated Load Amps
- (e) XLRA - Locked Rotor Amps - based on full winding (x-line) start units). YLRA for wye-delta starters is ~1/3 of LRA of x-line units.
- (f) MCA - Minimum Circuit Ampacity - 125 percent of largest compressor RLA plus 100 percent of all other loads.
- (g) Max fuse or MOP = 225 percent of the largest compressor RLA, plus the sum of the condenser fan FLA. (Use FLA per circuit, NOT FLA for the entire unit).

Table 10. Extra efficiency — high and wide ambient

Unit Size	Rated Voltage(a)	# Power Conn(b)	# Comp	Fans			Cntrl kVA(c)	RLA(d)		XLRA(e)		YLRA(e)		MCA(f)		MOP(g)		
				Qty Ckt1/2	kw	FLA		Ckt1	Ckt2	Ckt1	Ckt2	Ckt1	Ckt2	Ckt1	Ckt2	Ckt1	Ckt2	Ckt1
140	200/60/3	1	2	12	1.5	5.4	5.6	0.83	270	270	1845	1845	600	600	677		800	
	200/60/3	2	2	6/6	1.5	5.4	5.6	0.83	270	270	1845	1845	600	600	374	370	600	600
	230/60/3	1	2	12	1.5	5.4	5.6	0.83	235	235	1556	1556	506	506	598		800	
	230/60/3	2	2	6/6	1.5	5.4	5.6	0.83	235	235	1556	1556	506	506	330	326	500	500
	380/60/3	1	2	12	1.5	3.3	3.3	0.83	142	142	973	973	316	316	362		500	
	380/60/3	2	2	6/6	1.5	3.3	3.3	0.83	142	142	973	973	316	316	200	198	300	300
	460/60/3	1	2	12	1.5	2.7	2.7	0.83	118	118	774	774	252	252	300		400	
	460/60/3	2	2	6/6	1.5	2.7	2.7	0.83	118	118	774	774	252	252	166	164	250	250
	575/60/3	1	2	12	1.5	2.2	2.2	0.83	94	94	631	631	205	205	240		300	
	575/60/3	2	2	6/6	1.5	2.2	2.2	0.83	94	94	631	631	205	205	132	131	225	225
155	200/60/3	1	2	13	1.5	5.4	5.6	0.83	320	270	2156	1845	701	600	745		1000	
	200/60/3	2	2	7/6	1.5	5.4	5.6	0.83	320	270	2156	1845	701	600	442	370	700	600
	230/60/3	1	2	13	1.5	5.4	5.6	0.83	278	235	1756	1556	571	506	657		800	
	230/60/3	2	2	7/6	1.5	5.4	5.6	0.83	278	235	1756	1556	571	506	389	326	600	500
	380/60/3	1	2	13	1.5	3.3	3.5	0.83	168	142	1060	973	345	316	398		500	
	380/60/3	2	2	7/6	1.5	3.3	3.5	0.83	168	142	1060	973	345	316	236	198	400	300
	460/60/3	1	2	13	1.5	2.7	2.9	0.83	139	118	878	774	285	252	329		450	
	460/60/3	2	2	7/6	1.5	2.7	2.9	0.83	139	118	878	774	285	252	195	164	300	250
	575/60/3	1	2	13	1.5	2.2	2.4	0.83	111	94	705	631	229	205	263		350	
	575/60/3	2	2	7/6	1.5	2.2	2.4	0.83	111	94	705	631	229	205	156	131	250	225
170	200/60/3	1	2	14	1.5	5.4	5.6	0.83	320	320	2156	2156	701	701	800		1000	
	200/60/3	2	2	7/7	1.5	5.4	5.6	0.83	320	320	2156	2156	701	701	442	438	700	700
	230/60/3	1	2	14	1.5	5.4	5.6	0.83	278	278	1756	1756	571	571	705		800	
	230/60/3	2	2	7/7	1.5	5.4	5.6	0.83	278	278	1756	1756	571	571	389	386	600	600
	380/60/3	1	2	14	1.5	3.3	3.5	0.83	168	168	1060	1060	345	345	427		500	
	380/60/3	2	2	7/7	1.5	3.3	3.5	0.83	168	168	1060	1060	345	345	236	233	400	400
	460/60/3	1	2	14	1.5	2.7	2.9	0.83	139	139	878	878	285	285	353		450	
	460/60/3	2	2	7/7	1.5	2.7	2.9	0.83	139	139	878	878	285	285	195	193	300	300
	575/60/3	1	2	14	1.5	2.2	2.4	0.83	111	111	705	705	229	229	282		350	
	575/60/3	2	2	7/7	1.5	2.2	2.4	0.83	111	111	705	705	229	229	156	154	250	250

Electrical Data

Table 10. Extra efficiency — high and wide ambient (continued)

Unit Size	Rated Voltage ^(a)	# Power Conn ^(b)	# Comp	Fans			Cntrl kVA ^(c)	RLA ^(d)		XLRA ^(e)		YLRA ^(e)		MCA ^(f)		MOP ^(g)		
				Qty Ckt1/2	kw	FLA		VFD Input	Ckt1	Ckt2	Ckt1	Ckt2	Ckt1	Ckt2	Ckt1	Ckt2	Ckt1	Ckt2
185	200/60/3	1	2	14	1.5	5.4	5.6	0.83	386	320	2525	2156	821	701	883	1200		
	200/60/3	2	2	7/7	1.5	5.4	5.6	0.83	386	320	2525	2156	821	701	530	433	800	700
	230/60/3	1	2	14	1.5	5.4	5.6	0.83	336	278	2126	1756	691	571	778	1000		
	230/60/3	2	2	7/7	1.5	5.4	5.6	0.83	336	278	2126	1756	691	571	467	380	800	600
	380/60/3	1	2	14	1.5	3.3	3.5	0.83	203	168	1306	1060	424	345	471	600		
	380/60/3	2	2	7/7	1.5	3.3	3.5	0.83	203	168	1306	1060	424	345	283	230	450	350
	460/60/3	1	2	14	1.5	2.7	2.9	0.83	168	139	1065	878	346	285	389	500		
	460/60/3	2	2	7/7	1.5	2.7	2.9	0.83	168	139	1065	878	346	285	234	190	400	300
	575/60/3	1	2	14	1.5	2.2	2.4	0.83	134	111	853	705	277	229	311	400		
	575/60/3	2	2	7/7	1.5	2.2	2.4	0.83	134	111	853	705	277	229	187	152	300	250
200	200/60/3	1	2	16	1.5	5.4	5.6	0.83	386	386	2525	2525	821	821	959	1200		
	200/60/3	2	2	8/8	1.5	5.4	5.6	0.83	386	386	2525	2525	821	821	530	526	800	800
	230/60/3	1	2	16	1.5	5.4	5.6	0.83	336	336	2126	2126	691	691	846	1000		
	230/60/3	2	2	8/8	1.5	5.4	5.6	0.83	336	336	2126	2126	691	691	467	463	800	700
	380/60/3	1	2	16	1.5	3.3	3.5	0.83	203	203	1306	1306	424	424	512	700		
	380/60/3	2	2	8/8	1.5	3.3	3.5	0.83	203	203	1306	1306	424	424	283	280	450	450
	460/60/3	1	2	16	1.5	2.7	2.9	0.83	168	168	1065	1065	346	346	423	500		
	460/60/3	2	2	8/8	1.5	2.7	2.9	0.83	168	168	1065	1065	346	346	234	232	400	400
	575/60/3	1	2	16	1.5	2.2	2.4	0.83	134	134	853	853	277	277	339	450		
	575/60/3	2	2	8/8	1.5	2.2	2.4	0.83	134	134	853	853	277	277	187	185	300	300
250	200/60/3	1	n/a	n/a	n/a	n/a	n/a	n/a	n/a	n/a	n/a	n/a	n/a	n/a	n/a	n/a		
	200/60/3	2	3	12/6	1.5	5.4	5.6	1.2	270-270	386	1845-1845	2525	600-600	821	677	519	800	800
	230/60/3	1	n/a	n/a	n/a	n/a	n/a	n/a	n/a	n/a	n/a	n/a	n/a	n/a	n/a	n/a		
	230/60/3	2	3	12/6	1.5	5.4	5.6	1.2	235-235	336	1556-1556	2126	506-506	691	598	456	700	700
	380/60/3	1	n/a	n/a	n/a	n/a	n/a	n/a	n/a	n/a	n/a	n/a	n/a	n/a	n/a	n/a		
	380/60/3	2	3	12/6	1.5	3.3	3.5	1.2	142-142	203	973-973	1306	316-316	424	362	276	450	450
	460/60/3	1	3	18	1.5	2.7	2.9	1.2	118-118	168	774-774	1065	252-252	346	499	600		
	460/60/3	2	3	12/6	1.5	2.7	2.9	1.2	118-118	168	774-774	1065	252-252	346	300	228	350	350
	575/60/3	1	3	18	1.5	2.2	2.4	1.2	94-94	134	631-631	853	205-205	277	400	500		
	575/60/3	2	3	12/6	1.5	2.2	2.4	1.2	94-94	134	631-631	853	205-205	277	240	182	300	300

Table 10. Extra efficiency — high and wide ambient (continued)

Unit Size	Rated Voltage ^(a)	# Power Conn ^(b)	# Comp	Fans			Cntrl kVA ^(c)	RLA ^(d)		XLRA ^(e)		YLRA ^(e)		MCA ^(f)		MOP ^(g)	
				Qty Ckt1/2	kw	FLA		VFD Input	Ckt1	Ckt2	Ckt1	Ckt2	Ckt1	Ckt2	Ckt1	Ckt2	Ckt1
275	200/60/3	1	n/a	n/a	n/a	n/a	n/a	n/a	n/a	n/a	n/a	n/a	n/a	n/a	n/a	n/a	n/a
	200/60/3	2	3	14/6	1.5	5.4	5.6	320-320	386	2156-2156	2525	701-701	821	800	519	1000	800
	230/60/3	1	n/a	n/a	n/a	n/a	n/a	n/a	n/a	n/a	n/a	n/a	n/a	n/a	n/a	n/a	n/a
	230/60/3	2	3	14/6	1.5	5.4	5.6	278-278	336	1756-1756	2126	571-571	691	705	456	800	700
	380/60/3	1	n/a	n/a	n/a	n/a	n/a	n/a	n/a	n/a	n/a	n/a	n/a	n/a	n/a	n/a	n/a
	380/60/3	2	3	14/6	1.5	3.3	3.5	168-168	203	1060-1060	1306	345-345	424	427	276	500	450
	460/60/3	1	3	20	1.5	2.7	2.9	139-139	168	878-878	1065	285-285	346	547	700	700	700
	460/60/3	2	3	14/6	1.5	2.7	2.9	139-139	168	878-878	1065	285-285	346	353	228	450	350
	575/60/3	1	3	20	1.5	2.2	2.4	111-111	134	705-705	853	229-229	277	438	500	500	500
	575/60/3	2	3	14/6	1.5	2.2	2.4	111-111	134	705-705	853	229-229	277	282	182	350	300
300	200/60/3	1	n/a	n/a	n/a	n/a	n/a	n/a	n/a	n/a	n/a	n/a	n/a	n/a	n/a	n/a	n/a
	200/60/3	2	4	12/12	1.5	5.4	5.6	270-270	270-270	1845-1845	1845-1845	600-600	600-600	677	677	800	800
	230/60/3	1	n/a	n/a	n/a	n/a	n/a	n/a	n/a	n/a	n/a	n/a	n/a	n/a	n/a	n/a	n/a
	230/60/3	2	4	12/12	1.5	5.4	5.6	235-235	235-235	1556-1556	1556-1556	506-506	506-506	598	598	800	800
	380/60/3	1	n/a	n/a	n/a	n/a	n/a	n/a	n/a	n/a	n/a	n/a	n/a	n/a	n/a	n/a	n/a
	380/60/3	2	4	12/12	1.5	3.3	3.5	142-142	142-142	973-973	973-973	316-316	316-316	362	362	500	500
	460/60/3	1	4	24	1.5	2.7	2.9	118-118	118-118	774-774	774-774	252-252	252-252	571	571	600	600
	460/60/3	2	4	12/12	1.5	2.7	2.9	118-118	118-118	774-774	774-774	252-252	252-252	300	300	400	400
	575/60/3	1	4	24	1.5	2.2	2.4	94-94	94-94	631-631	631-631	205-205	205-205	456	456	500	500
	575/60/3	2	4	12/12	1.5	2.2	2.4	94-94	94-94	631-631	631-631	205-205	205-205	240	240	300	300
350	200/60/3	1	n/a	n/a	n/a	n/a	n/a	n/a	n/a	n/a	n/a	n/a	n/a	n/a	n/a	n/a	n/a
	200/60/3	2	4	14/14	1.5	5.4	5.6	320-320	320-320	2156-2156	2156-2156	701-701	701-701	800	800	1000	1000
	230/60/3	1	n/a	n/a	n/a	n/a	n/a	n/a	n/a	n/a	n/a	n/a	n/a	n/a	n/a	n/a	n/a
	230/60/3	2	4	14/14	1.5	5.4	5.6	278-278	278-278	1756-1756	1756-1756	571-571	571-571	705	705	1000	1000
	380/60/3	1	n/a	n/a	n/a	n/a	n/a	n/a	n/a	n/a	n/a	n/a	n/a	n/a	n/a	n/a	n/a
	380/60/3	2	4	14/14	1.5	3.3	3.5	168-168	168-168	1060-1060	1060-1060	345-345	345-345	427	427	500	500
	460/60/3	1	4	28	1.5	2.7	2.9	139-139	139-139	878-878	878-878	285-285	285-285	671	671	700	700
	460/60/3	2	4	14/14	1.5	2.7	2.9	139-139	139-139	878-878	878-878	285-285	285-285	353	353	450	450
	575/60/3	1	4	28	1.5	2.2	2.4	111-111	111-111	705-705	705-705	229-229	229-229	537	537	600	600
	575/60/3	2	4	14/14	1.5	2.2	2.4	111-111	111-111	705-705	705-705	229-229	229-229	282	282	350	350



Electrical Data

Table 10. Extra efficiency — high and wide ambient (continued)

Unit Size	Rated Voltage ^(a)	# Power Conn ^(b)	# Comp	Fans		VFD Input	Cntrl kVA ^(c)	RLA ^(d)		XLRA ^(e)		YLRA ^(e)		MCA ^(f)		MOP ^(g)		
				Qty Ckt1/2	kw			FLA	Ckt1	Ckt2	Ckt1	Ckt2	Ckt1	Ckt2	Ckt1	Ckt2	Ckt1	Ckt2

Note: Local codes may take precedence.

- (a) Voltage Utilization Range: +/- 10% of rated voltage. Rated voltage (Use range): 200/60/3 (180-220), 230/60/3 (208-254), 380/60/3 (342-418), 460/60/3 (414-506), 575/60/3 (516-633)
- (b) As standard, 140-250 ton units have a single point power connection. Optional dual point power connections are available. As standard, 275-500 ton units have dual point power connections. Optional single point power connections are available on 460V and 575V/60 Hz units.
- (c) Control VA includes operational controls only. It does not include evaporator heaters. A separate 115/60/1, 20 amp customer provided power connection is required to power the evaporator heaters (1640 watts).
- (d) RLA - Rated Load Amps
- (e) XLRA - Locked Rotor Amps - based on full winding (x-line) start units). YLRA for wye-delta starters is ~1/3 of LRA of x-line units.
- (f) MCA - Minimum Circuit Ampacity - 125 percent of largest compressor RLA plus 100 percent of all other loads.
- (g) Max fuse or MOP = 225 percent of the largest compressor RLA plus 100 percent of the second compressor RLA, plus the sum of the condenser fan FLA. (Use FLA per circuit, NOT FLA for the entire unit).

Table 11. Customer wire selection — standard efficiency

Unit Size	Single point power					Dual Point Power						
	Term Block	Disconnect	Circuit Breaker	Terminal Block		Disconnect		Circuit Breaker				
				Ckt 1	Ckt 2	Ckt 1	Ckt 2	Ckt 1	Ckt 2			
140	200	(2) 4 AWG - 500 MCM	(3) 3/0 - 500 MCM	(3) 3/0 - 500 MCM	(2) 4 AWG - 500 MCM	(2) 4 AWG - 500 MCM	(2) 2/0 - 500 MCM	(2) 2/0 - 500 MCM	(2) 2/0 - 500 MCM	(2) 2/0 - 500 MCM	(2) 2/0 - 500 MCM	(2) 2/0 - 500 MCM
	230	(2) 4 AWG - 500 MCM	(3) 3/0 - 500 MCM	(3) 3/0 - 500 MCM	4 AWG - 500 MCM	4 AWG - 500 MCM	(2) 2/0 - 500 MCM	(2) 2/0 - 500 MCM	(2) 2/0 - 500 MCM	(2) 2/0 - 500 MCM	(2) 2/0 - 500 MCM	(2) 2/0 - 500 MCM
	380	(2) 4 AWG - 500 MCM	(2) 2/0 - 500 MCM	(2) 2/0 - 500 MCM	4 AWG - 500 MCM	4 AWG - 500 MCM	(1) 1 AWG - 600 MCM or (2) 1 AWG - 250 MCM	(1) 1 AWG - 600 MCM or (2) 1 AWG - 250 MCM	(1) 1 AWG - 600 MCM or (2) 1 AWG - 250 MCM	(1) 1 AWG - 600 MCM or (2) 1 AWG - 250 MCM	(1) 1 AWG - 600 MCM or (2) 1 AWG - 250 MCM	(1) 1 AWG - 600 MCM or (2) 1 AWG - 250 MCM
155	460	4 AWG - 500 MCM	(1) 1 AWG - 600 MCM or (2) 1 AWG - 250 MCM	(1) 1 AWG - 600 MCM or (2) 1 AWG - 250 MCM	4 AWG - 500 MCM	4 AWG - 500 MCM	4 AWG - 500 MCM	4 AWG - 500 MCM	3/0-350MCM	3/0-350MCM	3/0-500MCM	3/0-500MCM
	575	4 AWG - 500 MCM	(1) 1 AWG - 600 MCM or (2) 1 AWG - 250 MCM	(1) 1 AWG - 600 MCM or (2) 1 AWG - 250 MCM	4 AWG - 500 MCM	4 AWG - 500 MCM	4 AWG - 500 MCM	4 AWG - 500 MCM	3/0-350MCM	3/0-350MCM	3/0-500MCM	3/0-500MCM
	200	(2) 4 AWG - 500 MCM	(4) 3/0 - 500 MCM	(4) 3/0 - 500 MCM	(2) 4 AWG - 500 MCM	(2) 4 AWG - 500 MCM	(2) 2/0 - 500 MCM	(2) 2/0 - 500 MCM	(3) 3/0 - 500 MCM	(2) 2/0 - 500 MCM	(2) 2/0 - 500 MCM	(2) 2/0 - 500 MCM
170	230	(2) 4 AWG - 500 MCM	(3) 3/0 - 500 MCM	(3) 3/0 - 500 MCM	(2) 4 AWG - 500 MCM	(2) 4 AWG - 500 MCM	(2) 2/0 - 500 MCM	(2) 2/0 - 500 MCM	(2) 2/0 - 500 MCM	(2) 2/0 - 500 MCM	(2) 2/0 - 500 MCM	(2) 2/0 - 500 MCM
	380	(2) 4 AWG - 500 MCM	(2) 2/0 - 500 MCM	(2) 2/0 - 500 MCM	4 AWG - 500 MCM	4 AWG - 500 MCM	4 AWG - 500 MCM	4 AWG - 500 MCM	3/0-350MCM	3/0-350MCM	3/0-500MCM	3/0-500MCM
	460	(2) 4 AWG - 500 MCM	(2) 2/0 - 500 MCM	(2) 2/0 - 500 MCM	4 AWG - 500 MCM	4 AWG - 500 MCM	4 AWG - 500 MCM	4 AWG - 500 MCM	(1) 1 AWG - 600 MCM or (2) 1 AWG - 250 MCM	(1) 1 AWG - 600 MCM or (2) 1 AWG - 250 MCM	(1) 1 AWG - 600 MCM or (2) 1 AWG - 250 MCM	(1) 1 AWG - 600 MCM or (2) 1 AWG - 250 MCM
575	4 AWG - 500 MCM	(1) 1 AWG - 600 MCM or (2) 1 AWG - 250 MCM	(1) 1 AWG - 600 MCM or (2) 1 AWG - 250 MCM	4 AWG - 500 MCM	4 AWG - 500 MCM	4 AWG - 500 MCM	4 AWG - 500 MCM	3/0-350MCM	3/0-350MCM	3/0-500MCM	3/0-500MCM	3/0-500MCM

Table 11. Customer wire selection — standard efficiency (continued)

Unit Size	Single point power					Dual Point Power				
	Term Block	Disconnect	Circuit Breaker	Terminal Block		Disconnect		Circuit Breaker		
				Ckt 1	Ckt 2	Ckt 1	Ckt 2	Ckt 1	Ckt 2	
185	200	(4) 2 AWG - 600 MCM	(4) 3/0 - 500 MCM	(4) 3/0 - 500 MCM	(2) 4 AWG - 500 MCM	(2) 4 AWG - 500 MCM	n/a	n/a	n/a	n/a
	230	(4) 2 AWG - 600 MCM	(4) 3/0 - 500 MCM	(4) 3/0 - 500 MCM	(2) 4 AWG - 500 MCM	(2) 4 AWG - 500 MCM	(3) 3/0 - 500 MCM	(2) 2/0 - 500 MCM	(3) 3/0 - 500 MCM	(2) 2/0 - 500 MCM
	380	(2) 4 AWG - 500 MCM	(2) 2/0 - 500 MCM	(2) 2/0 - 500 MCM	4 AWG - 500 MCM	4 AWG - 500 MCM	(2) 2/0 - 500 MCM	(1) 1 AWG - 600 MCM or (2) 1 AWG - 250 MCM	(2) 2/0 - 500 MCM	(1) 1 AWG - 600 MCM or (2) 1 AWG - 250 MCM
	460	(2) 4 AWG - 500 MCM	(2) 2/0 - 500 MCM	(2) 2/0 - 500 MCM	4 AWG - 500 MCM	4 AWG - 500 MCM	(1) 1 AWG - 600 MCM or (2) 1 AWG - 250 MCM	(1) 1 AWG - 600 MCM or (2) 1 AWG - 250 MCM	(1) 1 AWG - 600 MCM or (2) 1 AWG - 250 MCM	(1) 1 AWG - 600 MCM or (2) 1 AWG - 250 MCM
	575	4 AWG - 500 MCM	(1) 1 AWG - 600 MCM or (2) 1 AWG - 250 MCM	(1) 1 AWG - 600 MCM or (2) 1 AWG - 250 MCM	4 AWG - 500 MCM	4 AWG - 500 MCM	(1) 1 AWG - 600 MCM or (2) 1 AWG - 250 MCM	(1) 1 AWG - 600 MCM or (2) 1 AWG - 250 MCM	(1) 1 AWG - 600 MCM or (2) 1 AWG - 250 MCM	(1) 1 AWG - 600 MCM or (2) 1 AWG - 250 MCM
200	200	(4) 2 AWG - 600 MCM	(4) 3/0 - 500 MCM	(4) 3/0 - 500 MCM	(2) 4 AWG - 500 MCM	(2) 4 AWG - 500 MCM	n/a	n/a	n/a	n/a
	230	(4) 2 AWG - 600 MCM	(4) 3/0 - 500 MCM	(4) 3/0 - 500 MCM	(2) 4 AWG - 500 MCM	(2) 4 AWG - 500 MCM	n/a	n/a	n/a	n/a
	380	(2) 4 AWG - 500 MCM	(3) 3/0 - 500 MCM	(3) 3/0 - 500 MCM	4 AWG - 500 MCM	4 AWG - 500 MCM	(2) 2/0 - 500 MCM	(2) 2/0 - 500 MCM	(2) 2/0 - 500 MCM	(2) 2/0 - 500 MCM
	460	(2) 4 AWG - 500 MCM	(2) 2/0 - 500 MCM	(2) 2/0 - 500 MCM	4 AWG - 500 MCM	4 AWG - 500 MCM	(1) 1 AWG - 600 MCM or (2) 1 AWG - 250 MCM	(1) 1 AWG - 600 MCM or (2) 1 AWG - 250 MCM	(1) 1 AWG - 600 MCM or (2) 1 AWG - 250 MCM	(1) 1 AWG - 600 MCM or (2) 1 AWG - 250 MCM
	575	(2) 4 AWG - 500 MCM	(2) 2/0 - 500 MCM	(2) 2/0 - 500 MCM	4 AWG - 500 MCM	4 AWG - 500 MCM	(1) 1 AWG - 600 MCM or (2) 1 AWG - 250 MCM	(1) 1 AWG - 600 MCM or (2) 1 AWG - 250 MCM	(1) 1 AWG - 600 MCM or (2) 1 AWG - 250 MCM	(1) 1 AWG - 600 MCM or (2) 1 AWG - 250 MCM
225	200	(4) 2 AWG - 600 MCM	(4) 3/0 - 500 MCM	(4) 3/0 - 500 MCM	(2) 4 AWG - 500 MCM	(2) 4 AWG - 500 MCM	n/a	n/a	n/a	n/a
	230	(4) 2 AWG - 600 MCM	(4) 3/0 - 500 MCM	(4) 3/0 - 500 MCM	(2) 4 AWG - 500 MCM	(2) 4 AWG - 500 MCM	n/a	n/a	n/a	n/a
	380	(2) 4 AWG - 500 MCM	(3) 3/0 - 500 MCM	(3) 3/0 - 500 MCM	4 AWG - 500 MCM	4 AWG - 500 MCM	(2) 2/0 - 500 MCM	(2) 2/0 - 500 MCM	(2) 2/0 - 500 MCM	(2) 2/0 - 500 MCM
	460	(2) 4 AWG - 500 MCM	(2) 2/0 - 500 MCM	(2) 2/0 - 500 MCM	4 AWG - 500 MCM	4 AWG - 500 MCM	(1) 1 AWG - 600 MCM or (2) 1 AWG - 250 MCM	(1) 1 AWG - 600 MCM or (2) 1 AWG - 250 MCM	(1) 1 AWG - 600 MCM or (2) 1 AWG - 250 MCM	(1) 1 AWG - 600 MCM or (2) 1 AWG - 250 MCM
	575	(2) 4 AWG - 500 MCM	(2) 2/0 - 500 MCM	(2) 2/0 - 500 MCM	4 AWG - 500 MCM	4 AWG - 500 MCM	(1) 1 AWG - 600 MCM or (2) 1 AWG - 250 MCM	(1) 1 AWG - 600 MCM or (2) 1 AWG - 250 MCM	(1) 1 AWG - 600 MCM or (2) 1 AWG - 250 MCM	(1) 1 AWG - 600 MCM or (2) 1 AWG - 250 MCM

Table 11. Customer wire selection — standard efficiency (continued)

Unit Size	Single point power					Dual Point Power						
	Term Block	Disconnect	Circuit Breaker	Terminal Block		Disconnect		Circuit Breaker				
				Ckt 1	Ckt 2	Ckt 1	Ckt 2	Ckt 1	Ckt 2			
250	200	(4) 2 AWG - 600 MCM	(4) 3/0 - 500 MCM	(4) 3/0 - 500 MCM	(2) 4 AWG - 500 MCM	(2) 4 AWG - 500 MCM	n/a	n/a	n/a	n/a	n/a	n/a
	230	(4) 2 AWG - 600 MCM	(4) 3/0 - 500 MCM	(4) 3/0 - 500 MCM	(2) 4 AWG - 500 MCM	(2) 4 AWG - 500 MCM	n/a	n/a	n/a	n/a	n/a	n/a
	380	(2) 4 AWG - 500 MCM	(3) 3/0 - 500 MCM	(3) 3/0 - 500 MCM	4 AWG - 500 MCM	4 AWG - 500 MCM	(2) 2/0 - 500 MCM	(2) 2/0 - 500 MCM	(2) 2/0 - 500 MCM	(2) 2/0 - 500 MCM	(2) 2/0 - 500 MCM	(2) 2/0 - 500 MCM
	460	(2) 4 AWG - 500 MCM	(2) 2/0 - 500 MCM	(2) 2/0 - 500 MCM	4 AWG - 500 MCM	4 AWG - 500 MCM	(2) 2/0 - 500 MCM	(2) 2/0 - 500 MCM	(2) 2/0 - 500 MCM	(2) 2/0 - 500 MCM	(2) 2/0 - 500 MCM	(2) 2/0 - 500 MCM
	575	(2) 4 AWG - 500 MCM	(2) 2/0 - 500 MCM	(2) 2/0 - 500 MCM	4 AWG - 500 MCM	4 AWG - 500 MCM	(1) 1 AWG - 600 MCM or (2) 1 AWG - 250 MCM	(1) 1 AWG - 600 MCM or (2) 1 AWG - 250 MCM	(1) 1 AWG - 600 MCM or (2) 1 AWG - 250 MCM	(1) 1 AWG - 600 MCM or (2) 1 AWG - 250 MCM	(1) 1 AWG - 600 MCM or (2) 1 AWG - 250 MCM	(1) 1 AWG - 600 MCM or (2) 1 AWG - 250 MCM
275	200	n/a	n/a	n/a	(4) 4 AWG - 500 MCM	(2) 4 AWG - 500 MCM	(4) 3/0 - 500 MCM	(3) 3/0 - 500 MCM	(4) 3/0 - 500 MCM	(3) 3/0 - 500 MCM	(3) 3/0 - 500 MCM	(3) 3/0 - 500 MCM
	230	n/a	n/a	n/a	(2) 4 AWG - 500 MCM	4 AWG - 500 MCM	(3) 3/0 - 500 MCM	(3) 3/0 - 500 MCM	(3) 3/0 - 500 MCM	(3) 3/0 - 500 MCM	(3) 3/0 - 500 MCM	(3) 3/0 - 500 MCM
	380	(4) #2 - 600kcmil	n/a	(3) 3/0 - 500MCM	(2) 4 AWG - 500 MCM	4 AWG - 500 MCM	(2) 2/0 - 500 MCM	(2) 2/0 - 500 MCM	(2) 2/0 - 500 MCM	(2) 2/0 - 500 MCM	(2) 2/0 - 500 MCM	(2) 2/0 - 500 MCM
	460	(4) #2 - 600kcmil	n/a	(3) 3/0 - 500MCM	(2) 4 AWG - 500 MCM	4 AWG - 500 MCM	(2) 2/0 - 500 MCM	(2) 2/0 - 500 MCM	(2) 2/0 - 500 MCM	(2) 2/0 - 500 MCM	(2) 2/0 - 500 MCM	(2) 2/0 - 500 MCM
	575	(4) #2 - 600kcmil	n/a	(3) 3/0 - 500MCM	4 AWG - 500 MCM	4 AWG - 500 MCM	(1) 1 AWG - 600 MCM or (2) 1 AWG - 250 MCM	(1) 1 AWG - 600 MCM or (2) 1 AWG - 250 MCM	(1) 1 AWG - 600 MCM or (2) 1 AWG - 250 MCM	(1) 1 AWG - 600 MCM or (2) 1 AWG - 250 MCM	(1) 1 AWG - 600 MCM or (2) 1 AWG - 250 MCM	(1) 1 AWG - 600 MCM or (2) 1 AWG - 250 MCM
300	200	n/a	n/a	n/a	(4) 2 AWG - 600 MCM	(2) 4 AWG - 500 MCM	(4) 3/0 - 500 MCM	(3) 3/0 - 500 MCM	(4) 3/0 - 500 MCM	(3) 3/0 - 500 MCM	(3) 3/0 - 500 MCM	(3) 3/0 - 500 MCM
	230	n/a	n/a	n/a	(4) 2 AWG - 600 MCM	(2) 4 AWG - 500 MCM	(4) 3/0 - 500 MCM	(3) 3/0 - 500 MCM	(4) 3/0 - 500 MCM	(3) 3/0 - 500 MCM	(3) 3/0 - 500 MCM	(3) 3/0 - 500 MCM
	380	(4) #2 - 600kcmil	n/a	(3) 3/0 - 500MCM	(2) 4 AWG - 500 MCM	4 AWG - 500 MCM	(3) 3/0 - 500 MCM	(2) 2/0 - 500 MCM	(3) 3/0 - 500 MCM	(2) 2/0 - 500 MCM	(2) 2/0 - 500 MCM	(2) 2/0 - 500 MCM
	460	(4) #2 - 600kcmil	n/a	(3) 3/0 - 500MCM	(2) 4 AWG - 500 MCM	4 AWG - 500 MCM	(2) 2/0 - 500 MCM	(2) 2/0 - 500 MCM	(2) 2/0 - 500 MCM	(2) 2/0 - 500 MCM	(2) 2/0 - 500 MCM	(2) 2/0 - 500 MCM
	575	(4) #2 - 600kcmil	n/a	(3) 3/0 - 500MCM	(2) 4 AWG - 500 MCM	4 AWG - 500 MCM	(2) 2/0 - 500 MCM	(2) 2/0 - 500 MCM	(2) 2/0 - 500 MCM	(2) 2/0 - 500 MCM	(2) 2/0 - 500 MCM	(2) 2/0 - 500 MCM

Electrical Data
Table 11. Customer wire selection — standard efficiency (continued)

Unit Size	Volt	Single point power				Dual Point Power					
		Term Block	Disconnect	Circuit Breaker	Terminal Block		Disconnect		Circuit Breaker		
					Ckt 1	Ckt 2	Ckt 1	Ckt 2	Ckt 1	Ckt 2	
350	200	n/a	n/a	n/a	(4) 2 AWG - 600 MCM	(2) 4 AWG - 500 MCM	(4) 3/0 - 500 MCM	(3) 3/0 - 500 MCM	(4) 3/0 - 500 MCM	(3) 3/0 - 500 MCM	(4) 3/0 - 500 MCM
	230	n/a	n/a	n/a	(4) 2 AWG - 600 MCM	(2) 4 AWG - 500 MCM	(4) 3/0 - 500 MCM	(3) 3/0 - 500 MCM	(4) 3/0 - 500 MCM	(3) 3/0 - 500 MCM	(4) 3/0 - 500 MCM
	380	n/a	n/a	n/a	(2) 4 AWG - 500 MCM	4 AWG - 500 MCM	(3) 3/0 - 500 MCM	(2) 2/0 - 500 MCM	(3) 3/0 - 500 MCM	(2) 2/0 - 500 MCM	(4) 3/0 - 500 MCM
400	460	(4) #2 - 600kcmil	n/a	(3) 3/0 - 500MCM	(2) 4 AWG - 500 MCM	4 AWG - 500 MCM	(2) 2/0 - 500 MCM	(1) 1 AWG - 600 MCM or (2) 1 AWG - 250 MCM	(2) 2/0 - 500 MCM	(1) 1 AWG - 600 MCM or (2) 1 AWG - 250 MCM	(4) 3/0 - 500 MCM
	575	(4) #2 - 600kcmil	n/a	(3) 3/0 - 500MCM	(2) 4 AWG - 500 MCM	4 AWG - 500 MCM	(2) 2/0 - 500 MCM	(1) 1 AWG - 600 MCM or (2) 1 AWG - 250 MCM	(2) 2/0 - 500 MCM	(1) 1 AWG - 600 MCM or (2) 1 AWG - 250 MCM	(4) 3/0 - 500 MCM
	200	n/a	n/a	n/a	(4) 2 AWG - 600 MCM	(4) 2 AWG - 600 MCM	(4) 3/0 - 500 MCM	(4) 3/0 - 500 MCM	(4) 3/0 - 500 MCM	(4) 3/0 - 500 MCM	(4) 3/0 - 500 MCM
450	230	n/a	n/a	n/a	(4) 2 AWG - 600 MCM	(4) 2 AWG - 600 MCM	(4) 3/0 - 500 MCM	(4) 3/0 - 500 MCM	(4) 3/0 - 500 MCM	(4) 3/0 - 500 MCM	(4) 3/0 - 500 MCM
	380	n/a	n/a	n/a	(2) 4 AWG - 500 MCM	(2) 4 AWG - 500 MCM	(3) 3/0 - 500 MCM	(3) 3/0 - 500 MCM	(3) 3/0 - 500 MCM	(3) 3/0 - 500 MCM	(4) 3/0 - 500 MCM
	460	(4) #2 - 600kcmil	n/a	(3) 3/0 - 500MCM	(2) 4 AWG - 500 MCM	(2) 4 AWG - 500 MCM	(2) 2/0 - 500 MCM	(2) 2/0 - 500 MCM	(2) 2/0 - 500 MCM	(2) 2/0 - 500 MCM	(2) 2/0 - 500 MCM
500	575	(4) #2 - 600kcmil	n/a	(3) 3/0 - 500MCM	(2) 4 AWG - 500 MCM	4 AWG - 500 MCM	(2) 2/0 - 500 MCM	(2) 2/0 - 500 MCM	(2) 2/0 - 500 MCM	(2) 2/0 - 500 MCM	(4) 3/0 - 500 MCM
	200	n/a	n/a	n/a	(4) 2 AWG - 600 MCM	(4) 2 AWG - 600 MCM	(4) 3/0 - 500 MCM	(4) 3/0 - 500 MCM	(4) 3/0 - 500 MCM	(4) 3/0 - 500 MCM	(4) 3/0 - 500 MCM
	230	n/a	n/a	n/a	(4) 2 AWG - 600 MCM	(4) 2 AWG - 600 MCM	(4) 3/0 - 500 MCM	(4) 3/0 - 500 MCM	(4) 3/0 - 500 MCM	(4) 3/0 - 500 MCM	(4) 3/0 - 500 MCM

Table 11. Customer wire selection — standard efficiency (continued)

Unit Size	Single point power			Dual Point Power							
	Term Block	Disconnect	Circuit Breaker	Terminal Block		Disconnect		Circuit Breaker			
				Ckt 1	Ckt 2	Ckt 1	Ckt 2				

Notes:

1. Non-fused unit disconnect and circuit breaker are optional.
2. Copper wire only, based on nameplate minimum circuit ampacity (MCA).
3. Circuit breaker sizes are for factory mounted only.
4. n/a - not available

Electrical Data
Table 12. Customer wire selection — high efficiency

Unit Size	Volt	Ambient	Single point power						Dual Point Power											
			Term Block			Disconnect			Circuit Breaker			Terminal Block			Disconnect			Circuit Breaker		
			Term Block	Disconnect	Circuit Breaker	Ckt 1	Ckt 2	Ckt 1	Ckt 2	Ckt 1	Ckt 2	Ckt 1	Ckt 2	Ckt 1	Ckt 2	Ckt 1	Ckt 2			
140	200	All	(2) 4 AWG - 500 MCM	(3) 3/0 - 500 MCM	(3) 3/0 - 500 MCM	(2) 4 AWG - 500 MCM	(2) 4 AWG - 500 MCM	(2) 4 AWG - 500 MCM	(2) 2/0 - 500 MCM	(2) 2/0 - 500 MCM	(2) 4 AWG - 500 MCM	(2) 4 AWG - 500 MCM	(2) 2/0 - 500 MCM	(2) 2/0 - 500 MCM	(2) 2/0 - 500 MCM	(2) 2/0 - 500 MCM				
	230	All	(2) 4 AWG - 500 MCM	(3) 3/0 - 500 MCM	(3) 3/0 - 500 MCM	(2) 4 AWG - 500 MCM	(2) 4 AWG - 500 MCM	(2) 4 AWG - 500 MCM	(2) 2/0 - 500 MCM	(2) 2/0 - 500 MCM	4 AWG - 500 MCM	4 AWG - 500 MCM	(1) 1 AWG - 600 MCM or (2) 1 AWG - 250 MCM	(1) 1 AWG - 600 MCM or (2) 1 AWG - 250 MCM	(2) 2/0 - 500 MCM	(2) 2/0 - 500 MCM				
	380	All	(2) 4 AWG - 500 MCM	(2) 2/0 - 500 MCM	(2) 2/0 - 500 MCM	(2) 4 AWG - 500 MCM	(2) 4 AWG - 500 MCM	(2) 4 AWG - 500 MCM	(2) 2/0 - 500 MCM	(2) 2/0 - 500 MCM	4 AWG - 500 MCM	4 AWG - 500 MCM	(1) 1 AWG - 600 MCM or (2) 1 AWG - 250 MCM	(1) 1 AWG - 600 MCM or (2) 1 AWG - 250 MCM	(1) 1 AWG - 600 MCM or (2) 1 AWG - 250 MCM	(1) 1 AWG - 600 MCM or (2) 1 AWG - 250 MCM				
	460	Std, Low	4 AWG - 500 MCM	(1) 1 AWG - 600 MCM or (2) 1 AWG - 250 MCM	(1) 1 AWG - 600 MCM or (2) 1 AWG - 250 MCM	4 AWG - 500 MCM	4 AWG - 500 MCM	4 AWG - 500 MCM	4 AWG - 500 MCM	4 AWG - 500 MCM	4 AWG - 500 MCM	4 AWG - 500 MCM	3/0-350MCM	3/0-350MCM	3/0-350MCM	3/0-350MCM				
	460	High, Wide	4 AWG - 500 MCM	(2) 2/0 - 500 MCM	(2) 2/0 - 500 MCM	4 AWG - 500 MCM	4 AWG - 500 MCM	4 AWG - 500 MCM	4 AWG - 500 MCM	4 AWG - 500 MCM	4 AWG - 500 MCM	4 AWG - 500 MCM	3/0-350MCM	3/0-350MCM	3/0-350MCM	3/0-350MCM				
155	575	All	4 AWG - 500 MCM	(1) 1 AWG - 600 MCM or (2) 1 AWG - 250 MCM	(1) 1 AWG - 600 MCM or (2) 1 AWG - 250 MCM	4 AWG - 500 MCM	4 AWG - 500 MCM	4 AWG - 500 MCM	(1) 1 AWG - 600 MCM or (2) 1 AWG - 250 MCM	(1) 1 AWG - 600 MCM or (2) 1 AWG - 250 MCM	4 AWG - 500 MCM	4 AWG - 500 MCM	3/0-350MCM	3/0-350MCM	3/0-350MCM	3/0-350MCM				
	200	All	(2) 4 AWG - 500 MCM	(4) 3/0 - 500 MCM	(4) 3/0 - 500 MCM	(2) 4 AWG - 500 MCM	(2) 4 AWG - 500 MCM	(2) 4 AWG - 500 MCM	(4) 3/0 - 500 MCM	(4) 3/0 - 500 MCM	(2) 4 AWG - 500 MCM	(2) 4 AWG - 500 MCM	(3) 3/0 - 500 MCM	(2) 2/0 - 500 MCM	(3) 3/0 - 500 MCM	(2) 2/0 - 500 MCM				
	230	All	(2) 4 AWG - 500 MCM	(3) 3/0 - 500 MCM	(3) 3/0 - 500 MCM	(2) 4 AWG - 500 MCM	(2) 4 AWG - 500 MCM	(2) 4 AWG - 500 MCM	(3) 3/0 - 500 MCM	(3) 3/0 - 500 MCM	4 AWG - 500 MCM	4 AWG - 500 MCM	(1) 1 AWG - 600 MCM or (2) 1 AWG - 250 MCM	(1) 1 AWG - 600 MCM or (2) 1 AWG - 250 MCM	(2) 2/0 - 500 MCM	(2) 2/0 - 500 MCM				
	380	All	(2) 4 AWG - 500 MCM	(2) 2/0 - 500 MCM	(2) 2/0 - 500 MCM	(2) 4 AWG - 500 MCM	(2) 4 AWG - 500 MCM	(2) 4 AWG - 500 MCM	(2) 2/0 - 500 MCM	(2) 2/0 - 500 MCM	4 AWG - 500 MCM	4 AWG - 500 MCM	(1) 1 AWG - 600 MCM or (2) 1 AWG - 250 MCM	(1) 1 AWG - 600 MCM or (2) 1 AWG - 250 MCM	(1) 1 AWG - 600 MCM or (2) 1 AWG - 250 MCM	(1) 1 AWG - 600 MCM or (2) 1 AWG - 250 MCM				
	460	Std, Low	4 AWG - 500 MCM	(1) 1 AWG - 600 MCM or (2) 1 AWG - 250 MCM	(1) 1 AWG - 600 MCM or (2) 1 AWG - 250 MCM	4 AWG - 500 MCM	4 AWG - 500 MCM	4 AWG - 500 MCM	(1) 1 AWG - 600 MCM or (2) 1 AWG - 250 MCM	(1) 1 AWG - 600 MCM or (2) 1 AWG - 250 MCM	4 AWG - 500 MCM	4 AWG - 500 MCM	(1) 1 AWG - 600 MCM or (2) 1 AWG - 250 MCM	(1) 1 AWG - 600 MCM or (2) 1 AWG - 250 MCM	(1) 1 AWG - 600 MCM or (2) 1 AWG - 250 MCM	(1) 1 AWG - 600 MCM or (2) 1 AWG - 250 MCM				
460	High, Wide	4 AWG - 500 MCM	(2) 2/0 - 500 MCM	(2) 2/0 - 500 MCM	4 AWG - 500 MCM	4 AWG - 500 MCM	4 AWG - 500 MCM	(2) 2/0 - 500 MCM	(2) 2/0 - 500 MCM	4 AWG - 500 MCM	4 AWG - 500 MCM	(1) 1 AWG - 600 MCM or (2) 1 AWG - 250 MCM	(1) 1 AWG - 600 MCM or (2) 1 AWG - 250 MCM	(1) 1 AWG - 600 MCM or (2) 1 AWG - 250 MCM	(1) 1 AWG - 600 MCM or (2) 1 AWG - 250 MCM					
575	All	4 AWG - 500 MCM	(1) 1 AWG - 600 MCM or (2) 1 AWG - 250 MCM	(1) 1 AWG - 600 MCM or (2) 1 AWG - 250 MCM	4 AWG - 500 MCM	4 AWG - 500 MCM	4 AWG - 500 MCM	(1) 1 AWG - 600 MCM or (2) 1 AWG - 250 MCM	(1) 1 AWG - 600 MCM or (2) 1 AWG - 250 MCM	4 AWG - 500 MCM	4 AWG - 500 MCM	3/0-350MCM	3/0-350MCM	3/0-350MCM	3/0-350MCM					

Table 12. Customer wire selection — high efficiency (continued)

Unit Size	Volt	Ambient	Single point power				Dual Point Power							
			Term Block		Circuit Breaker	Terminal Block		Disconnect		Circuit Breaker				
			Term Block	Disconnect		Ckt 1	Ckt 2	Ckt 1	Ckt 2	Ckt 1	Ckt 2			
170	200	All	(4) 2 AWG - 600 MCM	(4) 3/0 - 500 MCM	(4) 3/0 - 500 MCM	(2) 4 AWG - 500 MCM	(2) 4 AWG - 500 MCM	n/a	n/a	n/a	n/a	(2) 2/0 - 500 MCM	n/a	
	230	All	(2) 4 AWG - 500 MCM	(3) 3/0 - 500 MCM	(3) 3/0 - 500 MCM	(2) 4 AWG - 500 MCM	(2) 4 AWG - 500 MCM	(2) 2/0 - 500 MCM	(2) 2/0 - 500 MCM	(1) 1 AWG - 600 MCM or (2) 1 AWG - 250 MCM	(1) 1 AWG - 600 MCM or (2) 1 AWG - 250 MCM	(1) 1 AWG - 600 MCM or (2) 1 AWG - 250 MCM	(2) 2/0 - 500 MCM	(2) 2/0 - 500 MCM
	380	All	(2) 4 AWG - 500 MCM	(2) 2/0 - 500 MCM	(2) 2/0 - 500 MCM	4 AWG - 500 MCM	4 AWG - 500 MCM	4 AWG - 500 MCM	4 AWG - 500 MCM	(1) 1 AWG - 600 MCM or (2) 1 AWG - 250 MCM	(1) 1 AWG - 600 MCM or (2) 1 AWG - 250 MCM	(1) 1 AWG - 600 MCM or (2) 1 AWG - 250 MCM	(1) 1 AWG - 600 MCM or (2) 1 AWG - 250 MCM	(1) 1 AWG - 600 MCM or (2) 1 AWG - 250 MCM
	460	All	(2) 4 AWG - 500 MCM	(2) 2/0 - 500 MCM	(2) 2/0 - 500 MCM	4 AWG - 500 MCM	4 AWG - 500 MCM	4 AWG - 500 MCM	4 AWG - 500 MCM	(1) 1 AWG - 600 MCM or (2) 1 AWG - 250 MCM	(1) 1 AWG - 600 MCM or (2) 1 AWG - 250 MCM	(1) 1 AWG - 600 MCM or (2) 1 AWG - 250 MCM	(1) 1 AWG - 600 MCM or (2) 1 AWG - 250 MCM	(1) 1 AWG - 600 MCM or (2) 1 AWG - 250 MCM
	575	All	4 AWG - 500 MCM	(1) 1 AWG - 600 MCM or (2) 1 AWG - 250 MCM	(1) 1 AWG - 600 MCM or (2) 1 AWG - 250 MCM	4 AWG - 500 MCM	4 AWG - 500 MCM	4 AWG - 500 MCM	4 AWG - 500 MCM	3/0 - 350 MCM	3/0 - 350 MCM	3/0 - 350 MCM	3/0 - 350 MCM	3/0 - 350 MCM
185	200	All	(4) 2 AWG - 600 MCM	(4) 3/0 - 500 MCM	(4) 3/0 - 500 MCM	(2) 4 AWG - 500 MCM	(2) 4 AWG - 500 MCM	n/a	n/a	n/a	n/a	n/a	n/a	n/a
	230	All	(4) 2 AWG - 600 MCM	(4) 3/0 - 500 MCM	(4) 3/0 - 500 MCM	(2) 4 AWG - 500 MCM	(2) 4 AWG - 500 MCM	(3) 3/0 - 500 MCM	(2) 2/0 - 500 MCM	(2) 2/0 - 500 MCM	(2) 2/0 - 500 MCM	(3) 3/0 - 500 MCM	(2) 2/0 - 500 MCM	(2) 2/0 - 500 MCM
	380	All	(2) 4 AWG - 500 MCM	(2) 2/0 - 500 MCM	(2) 2/0 - 500 MCM	4 AWG - 500 MCM	4 AWG - 500 MCM	4 AWG - 500 MCM	4 AWG - 500 MCM	(2) 2/0 - 500 MCM	(2) 2/0 - 500 MCM	(2) 2/0 - 500 MCM	(1) 1 AWG - 600 MCM or (2) 1 AWG - 250 MCM	(1) 1 AWG - 600 MCM or (2) 1 AWG - 250 MCM
	460	All	(2) 4 AWG - 500 MCM	(2) 2/0 - 500 MCM	(2) 2/0 - 500 MCM	4 AWG - 500 MCM	4 AWG - 500 MCM	4 AWG - 500 MCM	4 AWG - 500 MCM	(1) 1 AWG - 600 MCM or (2) 1 AWG - 250 MCM	(1) 1 AWG - 600 MCM or (2) 1 AWG - 250 MCM	(1) 1 AWG - 600 MCM or (2) 1 AWG - 250 MCM	(1) 1 AWG - 600 MCM or (2) 1 AWG - 250 MCM	(1) 1 AWG - 600 MCM or (2) 1 AWG - 250 MCM
	575	All	4 AWG - 500 MCM	(1) 1 AWG - 600 MCM or (2) 1 AWG - 250 MCM	(1) 1 AWG - 600 MCM or (2) 1 AWG - 250 MCM	4 AWG - 500 MCM	4 AWG - 500 MCM	4 AWG - 500 MCM	4 AWG - 500 MCM	(1) 1 AWG - 600 MCM or (2) 1 AWG - 250 MCM	(1) 1 AWG - 600 MCM or (2) 1 AWG - 250 MCM	(1) 1 AWG - 600 MCM or (2) 1 AWG - 250 MCM	(1) 1 AWG - 600 MCM or (2) 1 AWG - 250 MCM	3/0 - 350 MCM

Electrical Data

Table 12. Customer wire selection — high efficiency (continued)

Unit Size	Volt	Ambient	Single point power					Dual Point Power					
			Terminal Block		Circuit Breaker	Terminal Block		Disconnect		Circuit Breaker			
			Term Block	Disconnect		Ckt 1	Ckt 2	Ckt 1	Ckt 2	Ckt 1	Ckt 2		
200	200	All	(4) 2 AWG - 600 MCM	(4) 3/0 - 500 MCM	(4) 3/0 - 500 MCM	(2) 4 AWG - 500 MCM	(2) 4 AWG - 500 MCM	(2) 4 AWG - 500 MCM	(2) 4 AWG - 500 MCM	n/a	n/a	n/a	n/a
	230	All	(4) 2 AWG - 600 MCM	(4) 3/0 - 500 MCM	(4) 3/0 - 500 MCM	(2) 4 AWG - 500 MCM	(2) 4 AWG - 500 MCM	(2) 4 AWG - 500 MCM	(2) 4 AWG - 500 MCM	n/a	n/a	n/a	n/a
	380	All	(2) 4 AWG - 500 MCM	(2) 2/0 - 500 MCM	(2) 2/0 - 500 MCM	4 AWG - 500 MCM	4 AWG - 500 MCM	4 AWG - 500 MCM	4 AWG - 500 MCM	(2) 2/0 - 500 MCM	(2) 2/0 - 500 MCM	(2) 2/0 - 500 MCM	(2) 2/0 - 500 MCM
225	460	All	(2) 4 AWG - 500 MCM	(2) 2/0 - 500 MCM	(2) 2/0 - 500 MCM	4 AWG - 500 MCM	4 AWG - 500 MCM	4 AWG - 500 MCM	4 AWG - 500 MCM	(1) 1 AWG - 600 MCM or (2) 1 AWG - 250 MCM	(1) 1 AWG - 600 MCM or (2) 1 AWG - 250 MCM	(1) 1 AWG - 600 MCM or (2) 1 AWG - 250 MCM	(1) 1 AWG - 600 MCM or (2) 1 AWG - 250 MCM
	575	All	(2) 4 AWG - 500 MCM	(2) 2/0 - 500 MCM	(2) 2/0 - 500 MCM	4 AWG - 500 MCM	4 AWG - 500 MCM	4 AWG - 500 MCM	4 AWG - 500 MCM	(1) 1 AWG - 600 MCM or (2) 1 AWG - 250 MCM	(1) 1 AWG - 600 MCM or (2) 1 AWG - 250 MCM	(1) 1 AWG - 600 MCM or (2) 1 AWG - 250 MCM	(1) 1 AWG - 600 MCM or (2) 1 AWG - 250 MCM
	200	All	(4) 2 AWG - 600 MCM	(4) 3/0 - 500 MCM	(4) 3/0 - 500 MCM	(2) 4 AWG - 500 MCM	(2) 4 AWG - 500 MCM	(2) 4 AWG - 500 MCM	(2) 4 AWG - 500 MCM	n/a	n/a	n/a	n/a
250	200	All	(4) 2 AWG - 600 MCM	(4) 3/0 - 500 MCM	(4) 3/0 - 500 MCM	(2) 4 AWG - 500 MCM	(2) 4 AWG - 500 MCM	(2) 4 AWG - 500 MCM	(2) 4 AWG - 500 MCM	n/a	n/a	n/a	n/a
	230	All	(4) 2 AWG - 600 MCM	(4) 3/0 - 500 MCM	(4) 3/0 - 500 MCM	(2) 4 AWG - 500 MCM	(2) 4 AWG - 500 MCM	(2) 4 AWG - 500 MCM	(2) 4 AWG - 500 MCM	n/a	n/a	n/a	n/a
	380	All	(2) 4 AWG - 500 MCM	(2) 2/0 - 500 MCM	(2) 2/0 - 500 MCM	4 AWG - 500 MCM	4 AWG - 500 MCM	4 AWG - 500 MCM	4 AWG - 500 MCM	(2) 2/0 - 500 MCM	(2) 2/0 - 500 MCM	(2) 2/0 - 500 MCM	(2) 2/0 - 500 MCM
250	460	Std, Low	(4) 2 AWG - 600 MCM	(4) 3/0 - 500 MCM	(4) 3/0 - 500 MCM	(2) 4 AWG - 500 MCM	(2) 4 AWG - 500 MCM	(2) 4 AWG - 500 MCM	(2) 4 AWG - 500 MCM	(1) 1 AWG - 600 MCM or (2) 1 AWG - 250 MCM	(1) 1 AWG - 600 MCM or (2) 1 AWG - 250 MCM	(1) 1 AWG - 600 MCM or (2) 1 AWG - 250 MCM	(1) 1 AWG - 600 MCM or (2) 1 AWG - 250 MCM
	460	High, Wide	(4) 2 AWG - 600 MCM	(4) 3/0 - 500 MCM	(4) 3/0 - 500 MCM	(2) 4 AWG - 500 MCM	(2) 4 AWG - 500 MCM	(2) 4 AWG - 500 MCM	(2) 4 AWG - 500 MCM	(1) 1 AWG - 600 MCM or (2) 1 AWG - 250 MCM	(1) 1 AWG - 600 MCM or (2) 1 AWG - 250 MCM	(1) 1 AWG - 600 MCM or (2) 1 AWG - 250 MCM	(1) 1 AWG - 600 MCM or (2) 1 AWG - 250 MCM
	575	All	(2) 4 AWG - 500 MCM	(2) 2/0 - 500 MCM	(2) 2/0 - 500 MCM	4 AWG - 500 MCM	4 AWG - 500 MCM	4 AWG - 500 MCM	4 AWG - 500 MCM	(2) 2/0 - 500 MCM	(2) 2/0 - 500 MCM	(2) 2/0 - 500 MCM	(2) 2/0 - 500 MCM

Table 12. Customer wire selection — high efficiency (continued)

Unit Size	Volt	Ambient	Single point power				Dual Point Power				
			Term Block	Disconnect	Circuit Breaker	Terminal Block		Disconnect		Circuit Breaker	
						Ckt 1	Ckt 2	Ckt 1	Ckt 2	Ckt 1	Ckt 2
275	200	All	n/a	n/a	n/a	(4) 4 AWG - 600 MCM	(2) 4 AWG - 500 MCM	(4) 3/0 - 500 MCM	(3) 3/0 - 500 MCM	(4) 3/0 - 500 MCM	(3) 3/0 - 500 MCM
	230	All	n/a	n/a	n/a	(2) 4 AWG - 500 MCM	(4) 3/0 - 500 MCM	(3) 3/0 - 500 MCM	(3) 3/0 - 500 MCM	(4) 3/0 - 500 MCM	(3) 3/0 - 500 MCM
	380	All	(4) 4AWG - 600MCM	n/a	(3) 3/0 AWG - 500 MCM	(2) 4 AWG - 500 MCM	4 AWG - 500 MCM	(2) 2/0 - 500 MCM	(2) 2/0 - 500 MCM	(2) 2/0 - 500 MCM	(2) 2/0 - 500 MCM
	460	All	(4) 4AWG - 600MCM	n/a	(3) 3/0 AWG - 500 MCM	(2) 4 AWG - 500 MCM	4 AWG - 500 MCM	(2) 2/0 - 500 MCM	(1) 1 AWG - 600 MCM or (2) 1 AWG - 250 MCM	(2) 2/0 - 500 MCM	(1) 1 AWG - 600 MCM or (2) 1 AWG - 250 MCM
300	200	All	n/a	n/a	n/a	(4) 4 AWG - 600 MCM	(2) 4 AWG - 500 MCM	(4) 3/0 - 500 MCM	(3) 3/0 - 500 MCM	(4) 3/0 - 500 MCM	(3) 3/0 - 500 MCM
	230	All	n/a	n/a	n/a	(4) 4 AWG - 600 MCM	(2) 4 AWG - 500 MCM	(4) 3/0 - 500 MCM	(3) 3/0 - 500 MCM	(4) 3/0 - 500 MCM	(3) 3/0 - 500 MCM
	380	Std, Low	(4) 4AWG - 600MCM	n/a	(3) 3/0 AWG - 500 MCM	(2) 4 AWG - 500 MCM	4 AWG - 500 MCM	(2) 2/0 - 500 MCM	(2) 2/0 - 500 MCM	(2) 2/0 - 500 MCM	(2) 2/0 - 500 MCM
	380	High, Wide	(4) 4AWG - 600MCM	n/a	(3) 3/0 AWG - 500 MCM	(2) 4 AWG - 500 MCM	4 AWG - 500 MCM	(2) 2/0 - 500 MCM	(3) 3/0 - 500 MCM	(2) 2/0 - 500 MCM	(2) 2/0 - 500 MCM
350	460	All	(4) 4AWG - 600MCM	n/a	(3) 3/0 AWG - 500 MCM	(2) 4 AWG - 500 MCM	4 AWG - 500 MCM	(2) 2/0 - 500 MCM	(1) 1 AWG - 600 MCM or (2) 1 AWG - 250 MCM	(2) 2/0 - 500 MCM	(1) 1 AWG - 600 MCM or (2) 1 AWG - 250 MCM
	575	All	(4) 4AWG - 600MCM	n/a	(3) 3/0 AWG - 500 MCM	(2) 4 AWG - 500 MCM	4 AWG - 500 MCM	(2) 2/0 - 500 MCM	(1) 1 AWG - 600 MCM or (2) 1 AWG - 250 MCM	(2) 2/0 - 500 MCM	(1) 1 AWG - 600 MCM or (2) 1 AWG - 250 MCM
	200	All	n/a	n/a	n/a	(4) 4 AWG - 600 MCM	(4) 2 AWG - 600 MCM	(4) 3/0 - 500 MCM	(4) 3/0 - 500 MCM	(4) 3/0 - 500 MCM	(4) 3/0 - 500 MCM
	230	All	n/a	n/a	n/a	(2) 4 AWG - 500 MCM	(2) 4 AWG - 500 MCM	(3) 3/0 - 500 MCM	(3) 3/0 - 500 MCM	(3) 3/0 - 500 MCM	(3) 3/0 - 500 MCM
350	380	All	(4) 4AWG - 600MCM	n/a	(3) 3/0 AWG - 500 MCM	(2) 4 AWG - 500 MCM	(2) 4 AWG - 500 MCM	(2) 2/0 - 500 MCM	(2) 2/0 - 500 MCM	(2) 2/0 - 500 MCM	(2) 2/0 - 500 MCM
	460	All	(4) 4AWG - 600MCM	n/a	(3) 3/0 AWG - 500 MCM	(2) 4 AWG - 500 MCM	(2) 4 AWG - 500 MCM	(2) 2/0 - 500 MCM	(2) 2/0 - 500 MCM	(2) 2/0 - 500 MCM	(2) 2/0 - 500 MCM
	575	All	(4) 4AWG - 600MCM	n/a	(3) 3/0 AWG - 500 MCM	4 AWG - 500 MCM	(1) 1 AWG - 600 MCM or (2) 1 AWG - 250 MCM	(1) 1 AWG - 600 MCM or (2) 1 AWG - 250 MCM	(1) 1 AWG - 600 MCM or (2) 1 AWG - 250 MCM	(1) 1 AWG - 600 MCM or (2) 1 AWG - 250 MCM	

Electrical Data

Table 12. Customer wire selection — high efficiency (continued)

Unit Size	Volt	Ambient	Single point power			Dual Point Power					
			Term Block	Disconnect	Circuit Breaker	Terminal Block		Disconnect		Circuit Breaker	
						Ckt 1	Ckt 2	Ckt 1	Ckt 2	Ckt 1	Ckt 2
400	200	All	n/a	n/a	n/a	(4) 4 AWG - 600 MCM	(4) 2 AWG - 600 MCM	(4) 3/0 - 500 MCM	(4) 3/0 - 500 MCM	(4) 3/0 - 500 MCM	(4) 3/0 - 500 MCM
	230	All	n/a	n/a	n/a	(4) 4 AWG - 600 MCM	(4) 2 AWG - 600 MCM	(4) 3/0 - 500 MCM	(4) 3/0 - 500 MCM	(4) 3/0 - 500 MCM	(4) 3/0 - 500 MCM
	380	Std, Low	n/a	n/a	n/a	(2) 4 AWG - 500 MCM	(2) 4 AWG - 500 MCM	(2) 2/0 - 500 MCM	(2) 2/0 - 500 MCM	(2) 2/0 - 500 MCM	(2) 2/0 - 500 MCM
	380	High, Wide	n/a	n/a	n/a	(2) 4 AWG - 500 MCM	(2) 4 AWG - 500 MCM	(3) 3/0 - 500 MCM	(3) 3/0 - 500 MCM	(3) 3/0 - 500 MCM	(3) 3/0 - 500 MCM
	460	All	(4) 4AWG - 600MCM	n/a	(4) 3/0 AWG - 500 MCM	(2) 4 AWG - 500 MCM	(2) 4 AWG - 500 MCM	(2) 2/0 - 500 MCM	(2) 2/0 - 500 MCM	(2) 2/0 - 500 MCM	(2) 2/0 - 500 MCM
	575	All	(4) 4AWG - 600MCM	n/a	(3) 3/0 AWG - 500 MCM	(2) 4 AWG - 500 MCM	(2) 4 AWG - 500 MCM	(2) 2/0 - 500 MCM	(2) 2/0 - 500 MCM	(2) 2/0 - 500 MCM	(2) 2/0 - 500 MCM

Notes:

1. Non-fused unit disconnect and circuit breaker are optional.
2. Copper wire only, based on nameplate minimum circuit ampacity (MCA).
3. Circuit breaker sizes are for factory mounted only.
4. n/a - not available

Table 13. Customer wire selection — extra efficiency

Unit Size	Single point power				Dual Point Power					
	Circuit Breaker		Disconnect		Terminal Block		Disconnect		Circuit Breaker	
	Term Block	Disconnect	Circuit Breaker	Disconnect	Ckt 1	Ckt 2	Ckt 1	Ckt 2	Ckt 1	Ckt 2
140	200	(2) 4 AWG - 500 MCM	(3) 3/0 - 500 MCM	(3) 3/0 - 500 MCM	(2) 4 AWG - 500 MCM	(2) 4 AWG - 500 MCM	(2) 2/0 - 500 MCM	(2) 2/0 - 500 MCM	(2) 2/0 - 500 MCM	(2) 2/0 - 500 MCM
	230	(2) 4 AWG - 500 MCM	(3) 3/0 - 500 MCM	(3) 3/0 - 500 MCM	(2) 4 AWG - 500 MCM	4 AWG - 500 MCM	(2) 2/0 - 500 MCM	(2) 2/0 - 500 MCM	(2) 2/0 - 500 MCM	(2) 2/0 - 500 MCM
	380	(2) 4 AWG - 500 MCM	(2) 2/0 - 500 MCM	(2) 2/0 - 500 MCM	4 AWG - 500 MCM	4 AWG - 500 MCM	(1) #1 - 600 MCM or (2) #1 - 250 MCM	(1) #1 - 600 MCM or (2) #1 - 250 MCM	(1) #1 - 600 MCM or (2) #1 - 250 MCM	(1) #1 - 600 MCM or (2) #1 - 250 MCM
155	460	4 AWG - 500 MCM	(1) #1 - 600 MCM or (2) #1 - 250 MCM	(1) #1 - 600 MCM or (2) #1 - 250 MCM	4 AWG - 500 MCM	4 AWG - 500 MCM	3/0-350MCM	3/0-350MCM	3/0-350MCM	3/0-350MCM
	575	4 AWG - 500 MCM	(1) #1 - 600 MCM or (2) #1 - 250 MCM	(1) #1 - 600 MCM or (2) #1 - 250 MCM	4 AWG - 500 MCM	4 AWG - 500 MCM	3/0-350MCM	3/0-350MCM	3/0-350MCM	3/0-350MCM
	200	(2) 4 AWG - 500 MCM	(4) 3/0 - 500 MCM	(4) 3/0 - 500 MCM	(2) 4 AWG - 500 MCM	(2) 4 AWG - 500 MCM	(3) 3/0 - 500 MCM	(2) 2/0 - 500 MCM	(3) 3/0 - 500 MCM	(2) 2/0 - 500 MCM
170	230	(2) 4 AWG - 500 MCM	(3) 3/0 - 500 MCM	(3) 3/0 - 500 MCM	(2) 4 AWG - 500 MCM	4 AWG - 500 MCM	(2) 2/0 - 500 MCM	(2) 2/0 - 500 MCM	(2) 2/0 - 500 MCM	(2) 2/0 - 500 MCM
	380	(2) 4 AWG - 500 MCM	(2) 2/0 - 500 MCM	(2) 2/0 - 500 MCM	4 AWG - 500 MCM	4 AWG - 500 MCM	(1) #1 - 600 MCM or (2) #1 - 250 MCM	(1) #1 - 600 MCM or (2) #1 - 250 MCM	(1) #1 - 600 MCM or (2) #1 - 250 MCM	(1) #1 - 600 MCM or (2) #1 - 250 MCM
	460	(2) 4 AWG - 500 MCM	(2) 2/0 - 500 MCM	(2) 2/0 - 500 MCM	4 AWG - 500 MCM	4 AWG - 500 MCM	(1) #1 - 600 MCM or (2) #1 - 250 MCM	(1) #1 - 600 MCM or (2) #1 - 250 MCM	(1) #1 - 600 MCM or (2) #1 - 250 MCM	(1) #1 - 600 MCM or (2) #1 - 250 MCM
170	575	4 AWG - 500 MCM	(1) #1 - 600 MCM or (2) #1 - 250 MCM	(1) #1 - 600 MCM or (2) #1 - 250 MCM	4 AWG - 500 MCM	4 AWG - 500 MCM	3/0-350MCM	3/0-350MCM	3/0-350MCM	3/0-350MCM
	200	(4) 2 AWG - 600 MCM	(4) 3/0 - 500 MCM	(4) 3/0 - 500 MCM	(2) 4 AWG - 500 MCM	(2) 4 AWG - 500 MCM	n/a	n/a	n/a	n/a
	230	(2) 4 AWG - 500 MCM	(3) 3/0 - 500 MCM	(3) 3/0 - 500 MCM	(2) 4 AWG - 500 MCM	(2) 4 AWG - 500 MCM	(2) 2/0 - 500 MCM	(2) 2/0 - 500 MCM	(2) 2/0 - 500 MCM	(2) 2/0 - 500 MCM
170	380	(2) 4 AWG - 500 MCM	(2) 2/0 - 500 MCM	(2) 2/0 - 500 MCM	4 AWG - 500 MCM	4 AWG - 500 MCM	(1) #1 - 600 MCM or (2) #1 - 250 MCM	(1) #1 - 600 MCM or (2) #1 - 250 MCM	(1) #1 - 600 MCM or (2) #1 - 250 MCM	(1) #1 - 600 MCM or (2) #1 - 250 MCM
	460	(2) 4 AWG - 500 MCM	(2) 2/0 - 500 MCM	(2) 2/0 - 500 MCM	4 AWG - 500 MCM	4 AWG - 500 MCM	(1) #1 - 600 MCM or (2) #1 - 250 MCM	(1) #1 - 600 MCM or (2) #1 - 250 MCM	(1) #1 - 600 MCM or (2) #1 - 250 MCM	(1) #1 - 600 MCM or (2) #1 - 250 MCM
	575	4 AWG - 500 MCM	(1) #1 - 600 MCM or (2) #1 - 250 MCM	(1) #1 - 600 MCM or (2) #1 - 250 MCM	4 AWG - 500 MCM	4 AWG - 500 MCM	3/0-350MCM	3/0-350MCM	3/0-350MCM	3/0-350MCM

Electrical Data
Table 13. Customer wire selection — extra efficiency (continued)

Unit Size	Single point power						Dual Point Power					
	Circuit Breaker			Disconnect			Terminal Block		Disconnect		Circuit Breaker	
	Term Block	Disconnect	Circuit Breaker	Term Block	Disconnect	Circuit Breaker	Ckt 1	Ckt 2	Ckt 1	Ckt 2	Ckt 1	Ckt 2
185	200	(4) 2 AWG - 600 MCM	(4) 3/0 - 500 MCM	(4) 3/0 - 500 MCM	(2) 4 AWG - 500 MCM	(2) 4 AWG - 500 MCM	(2) 4 AWG - 500 MCM	(2) 4 AWG - 500 MCM	n/a	n/a	n/a	n/a
	230	(4) 2 AWG - 600 MCM	(4) 3/0 - 500 MCM	(4) 3/0 - 500 MCM	(2) 4 AWG - 500 MCM	(2) 4 AWG - 500 MCM	(2) 4 AWG - 500 MCM	(2) 4 AWG - 500 MCM	(3) 3/0 - 500 MCM	(2) 2/0 - 500 MCM	(3) 3/0 - 500 MCM	(2) 2/0 - 500 MCM
	380	(2) 4 AWG - 500 MCM	(2) 2/0 - 500 MCM	(2) 2/0 - 500 MCM	(2) 4 AWG - 500 MCM	(2) 4 AWG - 500 MCM	(2) 4 AWG - 500 MCM	(2) 4 AWG - 500 MCM	(2) 2/0 - 500 MCM	(1) #1 - 600 MCM or (2) #1 - 250 MCM	(2) 2/0 - 500 MCM	(1) #1 - 600 MCM or (2) #1 - 250 MCM
	460	(2) 4 AWG - 500 MCM	(2) 2/0 - 500 MCM	(2) 2/0 - 500 MCM	(2) 4 AWG - 500 MCM	(2) 4 AWG - 500 MCM	(2) 4 AWG - 500 MCM	(2) 4 AWG - 500 MCM	(1) #1 - 600 MCM or (2) #1 - 250 MCM	(1) #1 - 600 MCM or (2) #1 - 250 MCM	(1) #1 - 600 MCM or (2) #1 - 250 MCM	(1) #1 - 600 MCM or (2) #1 - 250 MCM
	575	4 AWG - 500 MCM	(1) #1 - 600 MCM or (2) #1 - 250 MCM	(1) #1 - 600 MCM or (2) #1 - 250 MCM	(2) 4 AWG - 500 MCM	(2) 4 AWG - 500 MCM	(2) 4 AWG - 500 MCM	(2) 4 AWG - 500 MCM	(1) #1 - 600 MCM or (2) #1 - 250 MCM	(1) #1 - 600 MCM or (2) #1 - 250 MCM	(1) #1 - 600 MCM or (2) #1 - 250 MCM	(1) #1 - 600 MCM or (2) #1 - 250 MCM
200	200A	(4) 2 AWG - 600 MCM	(4) 3/0 - 500 MCM	(4) 3/0 - 500 MCM	(2) 4 AWG - 500 MCM	(2) 4 AWG - 500 MCM	(2) 4 AWG - 500 MCM	(2) 4 AWG - 500 MCM	n/a	n/a	n/a	n/a
	230A	(4) 2 AWG - 600 MCM	(4) 3/0 - 500 MCM	(4) 3/0 - 500 MCM	(2) 4 AWG - 500 MCM	(2) 4 AWG - 500 MCM	(2) 4 AWG - 500 MCM	(2) 4 AWG - 500 MCM	n/a	n/a	n/a	n/a
	380A	(2) 4 AWG - 500 MCM	(3) 3/0 - 500 MCM	(3) 3/0 - 500 MCM	(2) 4 AWG - 500 MCM	(2) 4 AWG - 500 MCM	(2) 4 AWG - 500 MCM	(2) 4 AWG - 500 MCM	(2) 2/0 - 500 MCM	(2) 2/0 - 500 MCM	(2) 2/0 - 500 MCM	(2) 2/0 - 500 MCM
	460A	(2) 4 AWG - 500 MCM	(2) 2/0 - 500 MCM	(2) 2/0 - 500 MCM	(2) 4 AWG - 500 MCM	(2) 4 AWG - 500 MCM	(2) 4 AWG - 500 MCM	(2) 4 AWG - 500 MCM	(1) #1 - 600 MCM or (2) #1 - 250 MCM	(1) #1 - 600 MCM or (2) #1 - 250 MCM	(1) #1 - 600 MCM or (2) #1 - 250 MCM	(1) #1 - 600 MCM or (2) #1 - 250 MCM
	575A	(2) 4 AWG - 500 MCM	(2) 2/0 - 500 MCM	(2) 2/0 - 500 MCM	(2) 4 AWG - 500 MCM	(2) 4 AWG - 500 MCM	(2) 4 AWG - 500 MCM	(2) 4 AWG - 500 MCM	(1) #1 - 600 MCM or (2) #1 - 250 MCM	(1) #1 - 600 MCM or (2) #1 - 250 MCM	(1) #1 - 600 MCM or (2) #1 - 250 MCM	(1) #1 - 600 MCM or (2) #1 - 250 MCM
250	200A	n/a	n/a	n/a	n/a	n/a	(2) 4 AWG - 500 MCM	(2) 4 AWG - 500 MCM	(3) 3/0 - 500 MCM	(3) 3/0 - 500 MCM	(3) 3/0 - 500 MCM	(3) 3/0 - 500 MCM
	230A	n/a	n/a	n/a	n/a	n/a	(2) 4 AWG - 500 MCM	(2) 4 AWG - 500 MCM	(3) 3/0 - 500 MCM	(3) 3/0 - 500 MCM	(3) 3/0 - 500 MCM	(3) 3/0 - 500 MCM
	380A	(4) 4AWG - 600MCM	n/a	(3) 3/0 - 500MCM	(2) 4 AWG - 500 MCM	(2) 4 AWG - 500 MCM	(2) 4 AWG - 500 MCM	(2) 4 AWG - 500 MCM	(2) 2/0 - 500 MCM	(2) 2/0 - 500 MCM	(2) 2/0 - 500 MCM	(2) 2/0 - 500 MCM
	460A	(4) 4AWG - 600MCM	n/a	(3) 3/0 - 500MCM	(2) 4 AWG - 500 MCM	(2) 4 AWG - 500 MCM	(2) 4 AWG - 500 MCM	(2) 4 AWG - 500 MCM	(2) 2/0 - 500 MCM	(1) #1 - 600 MCM or (2) #1 - 250 MCM	(1) #1 - 600 MCM or (2) #1 - 250 MCM	(1) #1 - 600 MCM or (2) #1 - 250 MCM
	575A	(4) 4AWG - 600MCM	n/a	(3) 3/0 - 500MCM	(2) 4 AWG - 500 MCM	(2) 4 AWG - 500 MCM	(2) 4 AWG - 500 MCM	(2) 4 AWG - 500 MCM	(1) #1 - 600 MCM or (2) #1 - 250 MCM	(1) #1 - 600 MCM or (2) #1 - 250 MCM	(1) #1 - 600 MCM or (2) #1 - 250 MCM	(1) #1 - 600 MCM or (2) #1 - 250 MCM

Table 13. Customer wire selection — extra efficiency (continued)

Unit Size	Single point power				Dual Point Power							
	Term Block	Disconnect	Circuit Breaker	Ckt 1	Terminal Block		Disconnect		Circuit Breaker			
					Ckt 1	Ckt 2	Ckt 1	Ckt 2	Ckt 1	Ckt 2		
275	200A	n/a	n/a	(4) 2 AWG - 600 MCM	(2) 4 AWG - 500 MCM	(4) 3/0 - 500 MCM	(3) 3/0 - 500 MCM	(4) 3/0 - 500 MCM	(3) 3/0 - 500 MCM	(3) 3/0 - 500 MCM	(4) 3/0 - 500 MCM	(3) 3/0 - 500 MCM
	230A	n/a	n/a	(2) 4 AWG - 500 MCM	(2) 4 AWG - 500 MCM	(3) 3/0 - 500 MCM	(3) 3/0 - 500 MCM	(3) 3/0 - 500 MCM	(3) 3/0 - 500 MCM	(3) 3/0 - 500 MCM	(3) 3/0 - 500 MCM	(3) 3/0 - 500 MCM
	380A	(4) 4AWG - 600MCM	n/a	(3) 3/0 - 500MCM	4 AWG - 500 MCM	(2) 2/0 - 500 MCM	(2) 2/0 - 500 MCM	(2) 2/0 - 500 MCM	(2) 2/0 - 500 MCM	(2) 2/0 - 500 MCM	(2) 2/0 - 500 MCM	(2) 2/0 - 500 MCM
	460A	(4) 4AWG - 600MCM	n/a	(3) 3/0 - 500MCM	4 AWG - 500 MCM	(2) 2/0 - 500 MCM	(2) 2/0 - 500 MCM	(2) 2/0 - 500 MCM	(2) 2/0 - 500 MCM	(2) 2/0 - 500 MCM	(2) 2/0 - 500 MCM	(2) 2/0 - 500 MCM
	575A	(4) 4AWG - 600MCM	n/a	(3) 3/0 - 500MCM	4 AWG - 500 MCM	(1) #1 - 600 MCM or (2) #1 - 250 MCM	(1) #1 - 600 MCM or (2) #1 - 250 MCM	(1) #1 - 600 MCM or (2) #1 - 250 MCM	(1) #1 - 600 MCM or (2) #1 - 250 MCM	(1) #1 - 600 MCM or (2) #1 - 250 MCM	(1) #1 - 600 MCM or (2) #1 - 250 MCM	(1) #1 - 600 MCM or (2) #1 - 250 MCM
300	200A	n/a	n/a	(2) 4 AWG - 500 MCM	(2) 4 AWG - 500 MCM	(3) 3/0 - 500 MCM	(3) 3/0 - 500 MCM	(3) 3/0 - 500 MCM	(3) 3/0 - 500 MCM	(3) 3/0 - 500 MCM	(3) 3/0 - 500 MCM	(3) 3/0 - 500 MCM
	230A	n/a	n/a	(2) 4 AWG - 500 MCM	(2) 4 AWG - 500 MCM	(3) 3/0 - 500 MCM	(3) 3/0 - 500 MCM	(3) 3/0 - 500 MCM	(3) 3/0 - 500 MCM	(3) 3/0 - 500 MCM	(3) 3/0 - 500 MCM	(3) 3/0 - 500 MCM
	380A	(4) 4AWG - 600MCM	n/a	(3) 3/0 - 500MCM	(2) 4 AWG - 500 MCM	(2) 2/0 - 500 MCM	(2) 2/0 - 500 MCM	(2) 2/0 - 500 MCM	(2) 2/0 - 500 MCM	(2) 2/0 - 500 MCM	(2) 2/0 - 500 MCM	(2) 2/0 - 500 MCM
	460A	(4) 4AWG - 600MCM	n/a	(3) 3/0 - 500MCM	4 AWG - 500 MCM	(1) #1 - 600 MCM or (2) #1 - 250 MCM	(1) #1 - 600 MCM or (2) #1 - 250 MCM	(1) #1 - 600 MCM or (2) #1 - 250 MCM	(1) #1 - 600 MCM or (2) #1 - 250 MCM	(1) #1 - 600 MCM or (2) #1 - 250 MCM	(1) #1 - 600 MCM or (2) #1 - 250 MCM	(1) #1 - 600 MCM or (2) #1 - 250 MCM
	575A	(4) 4AWG - 600MCM	n/a	(3) 3/0 - 500MCM	4 AWG - 500 MCM	(1) #1 - 600 MCM or (2) #1 - 250 MCM	(1) #1 - 600 MCM or (2) #1 - 250 MCM	(1) #1 - 600 MCM or (2) #1 - 250 MCM	(1) #1 - 600 MCM or (2) #1 - 250 MCM	(1) #1 - 600 MCM or (2) #1 - 250 MCM	(1) #1 - 600 MCM or (2) #1 - 250 MCM	(1) #1 - 600 MCM or (2) #1 - 250 MCM
350	200A	n/a	n/a	(4) 2 AWG - 600 MCM	(4) 2 AWG - 600 MCM	(4) 3/0 - 500 MCM	(4) 3/0 - 500 MCM	(4) 3/0 - 500 MCM	(4) 3/0 - 500 MCM	(4) 3/0 - 500 MCM	(4) 3/0 - 500 MCM	(4) 3/0 - 500 MCM
	230A	n/a	n/a	(2) 4 AWG - 500 MCM	(2) 4 AWG - 500 MCM	(3) 3/0 - 500 MCM	(3) 3/0 - 500 MCM	(3) 3/0 - 500 MCM	(3) 3/0 - 500 MCM	(3) 3/0 - 500 MCM	(3) 3/0 - 500 MCM	(3) 3/0 - 500 MCM
	380A	(4) 4AWG - 600MCM	n/a	(3) 3/0 - 500MCM	(2) 4 AWG - 500 MCM	(2) 2/0 - 500 MCM	(2) 2/0 - 500 MCM	(2) 2/0 - 500 MCM	(2) 2/0 - 500 MCM	(2) 2/0 - 500 MCM	(2) 2/0 - 500 MCM	(2) 2/0 - 500 MCM
	460A	(4) 4AWG - 600MCM	n/a	(3) 3/0 - 500MCM	(2) 4 AWG - 500 MCM	(2) 2/0 - 500 MCM	(2) 2/0 - 500 MCM	(2) 2/0 - 500 MCM	(2) 2/0 - 500 MCM	(2) 2/0 - 500 MCM	(2) 2/0 - 500 MCM	(2) 2/0 - 500 MCM
	575A	(4) 4AWG - 600MCM	n/a	(3) 3/0 - 500MCM	4 AWG - 500 MCM	(1) #1 - 600 MCM or (2) #1 - 250 MCM	(1) #1 - 600 MCM or (2) #1 - 250 MCM	(1) #1 - 600 MCM or (2) #1 - 250 MCM	(1) #1 - 600 MCM or (2) #1 - 250 MCM	(1) #1 - 600 MCM or (2) #1 - 250 MCM	(1) #1 - 600 MCM or (2) #1 - 250 MCM	(1) #1 - 600 MCM or (2) #1 - 250 MCM

Notes:

1. Non-fused unit disconnect and circuit breaker are optional.
2. Copper wire only, based on nameplate minimum circuit ampacity (MCA).
3. Circuit breaker sizes are for factory mounted only.
4. n/a - not available

Electrical Connection

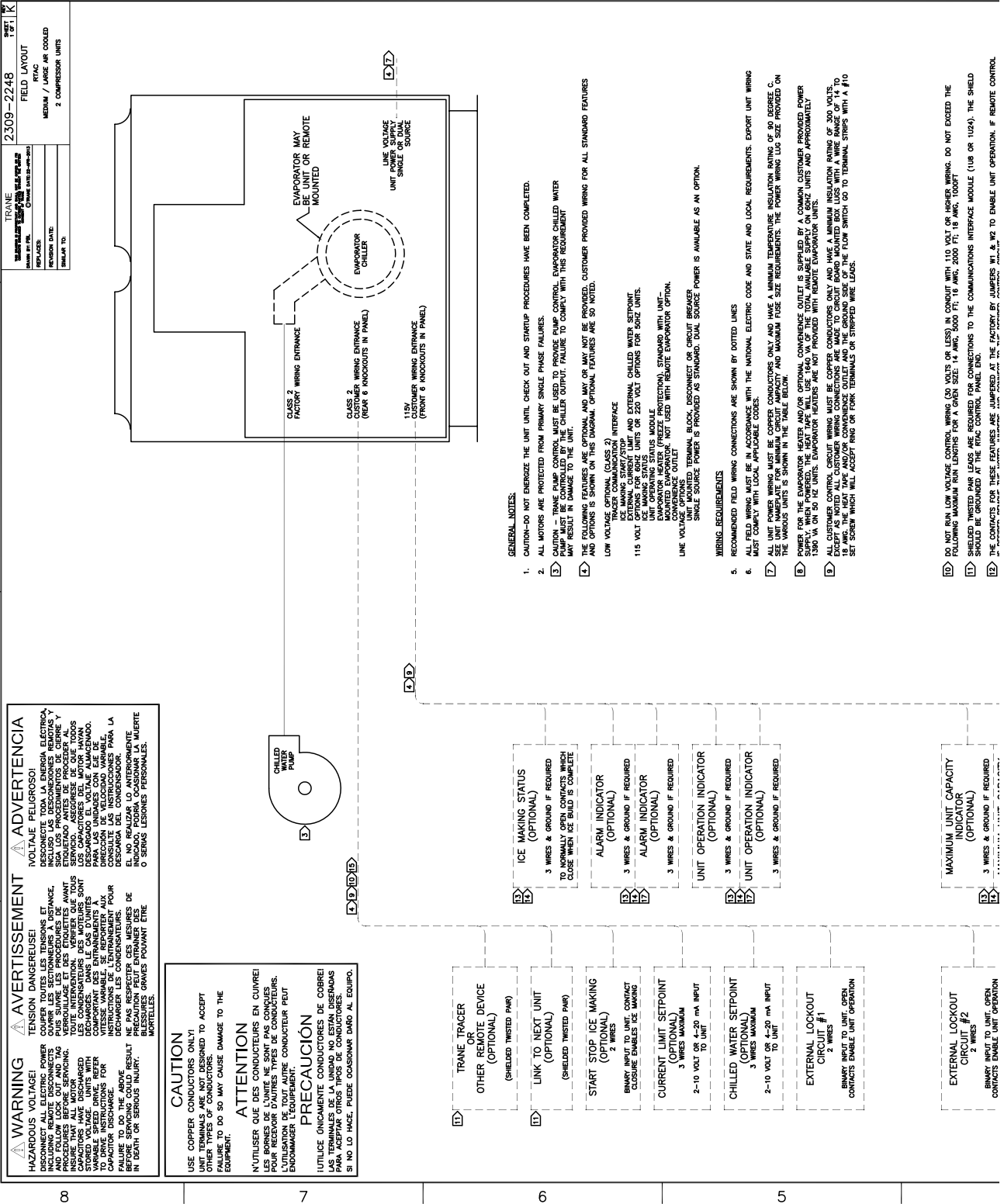

HAZARDOUS VOLTAGE!
 INCLUDING REMOTE LOCATIONS
 AND FOLLOW LOCK-OUT AND TAG-OUT PROCEDURES TO AVOID CONTACT WITH LIVE ELECTRICAL PARTS.
 INSURE THAT ALL MOTORS ARE DE-ENERGIZED AND GROUNDING IS VERIFIED BEFORE ANY WORK IS PERFORMED.
 CAPACITORS MAY BE CHARGED AND STORE ENERGY. REFER TO THE CAPACITOR DISCHARGE INSTRUCTIONS FOR THE UNIT.
 FAILURE TO DO THE ABOVE MAY RESULT IN DEATH OR SERIOUS INJURY.

AVERTISSEMENT DANGEREUX!
 TENSION DANGEREUSE!
 Y COMPRIS LES ENDROITS LOUÉS À DISTANCE.
 SUIVRE LES PROCÉDURES DE VERIFICATION ET D'ÉTATIFICATION AVANT DE COMMENCER TOUT TRAVAIL ÉLECTRIQUE.
 S'ASSURER QUE TOUS LES MOTORS SONT DÉ-ÉNERGÉS ET GROUNDING EST VÉRIFIÉ AVANT QUE TOUT TRAVAIL ÉLECTRIQUE SOIT ENTREPRIS.
 LES CONDENSATEURS PEUVENT ÊTRE CHARGÉS ET STOCKER DE L'ÉNERGIE. RÉFÉRENCEZ-VOUS AUX INSTRUCTIONS DE DÉCHARGEMENT DES CONDENSATEURS.
 LE NON-RESPECT DE CES PROCÉDURES PEUT CAUSER LA MORT OU DES BLESSURES GRAVES POUVANT ÊTRE IRRÉVERSIBLES.

CAUTION
 USE COPPER CONDUCTORS ONLY!
 ALL WIRING MUST BE PERFORMED TO ACCEPT OTHER TYPES OF CONDUCTORS.
 FAILURE TO DO SO MAY CAUSE DAMAGE TO THE EQUIPMENT.

ATTENTION
 N'UTILISER QUE DES CONDUCTEURS EN CUIVRE!
 TOUTE LA RÉSEAUX ÉLECTRIQUE DOIT ÊTRE CONFORME À LA NORME POUR ACCEPTER D'AUTRES TYPES DE CONDUCTEURS.
 L'UTILISATION DE TOUT AUTRE CONDUCTEUR PEUT ENDOMMAGER L'ÉQUIPEMENT.

PRECAUCIÓN
 ¡UTILICE ÚNICAMENTE CONDUCTORES DE COBRE!
 LAS TERMINALES DE LA UNIDAD NO ESTÁN DISEÑADAS PARA ACEPTAR OTROS TIPOS DE CONDUCTORES.
 SI NO LO HACE, PUEDE CAUSAR DAÑO AL EQUIPO.

- 15 CHILLED WATER PUMP
- 16 ICE MAKING STATUS (OPTIONAL)
3 WIRES & GROUND IF REQUIRED TO NORMALLY OPEN CONTACTS WHEN CLOSE WHEN ICE BUILD IS COMPLETE
- 17 ALARM INDICATOR (OPTIONAL)
3 WIRES & GROUND IF REQUIRED
- 18 ALARM INDICATOR (OPTIONAL)
3 WIRES & GROUND IF REQUIRED
- 19 UNIT OPERATION INDICATOR (OPTIONAL)
3 WIRES & GROUND IF REQUIRED
- 20 UNIT OPERATION INDICATOR (OPTIONAL)
3 WIRES & GROUND IF REQUIRED
- 21 MAXIMUM UNIT CAPACITY (OPTIONAL)
3 WIRES & GROUND IF REQUIRED
- 22 TRANE TRACER OR OTHER REMOTE DEVICE (SHIELDED TWISTED PAIR) (OPTIONAL)
- 23 LINK TO NEXT UNIT (OPTIONAL) (SHIELDED TWISTED PAIR)
- 24 START STOP ICE MAKING (OPTIONAL)
2 WIRES
BINARY INPUT TO UNIT, CONTACTS SHIELDED TWISTED PAIR
- 25 CURRENT LIMIT SETPOINT (OPTIONAL)
3 WIRES MAXIMUM
2-10 VOLT OR 4-20 mA INPUT TO UNIT
- 26 CHILLED WATER SETPOINT (OPTIONAL)
3 WIRES MAXIMUM
2-10 VOLT OR 4-20 mA INPUT TO UNIT
- 27 EXTERNAL LOCKOUT CIRCUIT #1 (OPTIONAL)
2 WIRES
BINARY INPUT TO UNIT, OPEN CONTACTS SHIELD TWISTED PAIR
- 28 EXTERNAL LOCKOUT CIRCUIT #2 (OPTIONAL)
2 WIRES
BINARY INPUT TO UNIT, OPEN CONTACTS SHIELD TWISTED PAIR

- GENERAL NOTES:**
1. CAUTION-DO NOT ENERGIZE THE UNIT UNTIL CHECK OUT AND STARTUP PROCEDURES HAVE BEEN COMPLETED.
 2. ALL MOTORS ARE PROTECTED FROM PRIMARY SINGLE PHASE FAILURES.
 3. TRANE PUMP CONTROL MUST BE USED TO PROVIDE PUMP CONTROL. EVAPORATOR CHILLED WATER CHILLER OUTPUT. FAILURE TO COMPLY WITH THIS REQUIREMENT MAY RESULT IN DAMAGE TO THE UNIT.
 4. THE FOLLOWING FEATURES ARE OPTIONAL AND MAY OR MAY NOT BE PROVIDED. CUSTOMER PROVIDED WIRING FOR ALL STANDARD FEATURES AND OPTIONS IS SHOWN ON THIS DIAGRAM. OPTIONAL FEATURES ARE SO NOTED.
- LOW VOLTAGE OPTIONAL (CLASS 2)**
 TRANE COMMUNICATION INTERFACE
 EXTERNAL CURRENT LIMIT AND EXTERNAL CHILLED WATER SETPOINT
 115 VOLT ICE MAKING STATUS
 UNIT OPERATING STATUS MODULE
 MOUNTED EVAPORATOR. NOT USED WITH REMOTE EVAPORATOR OPTION.
 LINE VOLTAGE OPTIONS
 UNIT MOUNTED TERMINAL BLOCK, DISCONNECT OR CIRCUIT BREAKER
 SINGLE SOURCE POWER IS PROVIDED TO STANDARD LOCAL SOURCE POWER IS AVAILABLE AS AN OPTION.
- WIRING REQUIREMENTS**
5. RECOMMENDED FIELD WIRING CONNECTIONS ARE SHOWN BY DOTTED LINES
 6. ALL FIELD WIRING MUST BE IN ACCORDANCE WITH THE NATIONAL ELECTRIC CODE AND STATE AND LOCAL REQUIREMENTS. EXCEPT UNIT WIRING MUST COMPLY WITH LOCAL APPLICABLE CODES.
 7. ALL UNIT POWER WIRING MUST BE COPPER CONDUCTORS ONLY AND HAVE A MINIMUM TEMPERATURE INSULATION RATING OF 90 DEGREE C. SEE UNIT NAMEPLATE FOR MINIMUM CIRCUIT AMPACITY AND MAXIMUM FUSE SIZE REQUIREMENTS. THE POWER WIRING LOG SIZE PROVIDED ON THE NAMEPLATE IS SHOWN IN THE TABLE BELOW.
 8. ALL WIRING MUST BE IN ACCORDANCE WITH THE NATIONAL ELECTRIC CODE AND STATE AND LOCAL REQUIREMENTS. EXCEPT UNIT WIRING MUST COMPLY WITH LOCAL APPLICABLE CODES.
 9. ALL CUSTOMER CONTROL CIRCUIT WIRING MUST BE COPPER CONDUCTORS ONLY AND HAVE A MINIMUM INSULATION RATING OF 300 VOLTS. ALL CUSTOMER CONTROL CIRCUIT WIRING MUST BE IN ACCORDANCE WITH THE NATIONAL ELECTRIC CODE AND STATE AND LOCAL REQUIREMENTS. EXCEPT UNIT WIRING MUST COMPLY WITH LOCAL APPLICABLE CODES.
 10. THE HEAT TACK AND/OR CONDUITANCE GUTLET AND THE GROUND SIDE OF THE FLOW SWITCH GO TO TERMINAL STRIPS WITH A #10 SET SCREW WHICH WILL ACCEPT RING OR FORK TERMINALS OR STRIPPED WIRE LEADS.

Electrical Connection

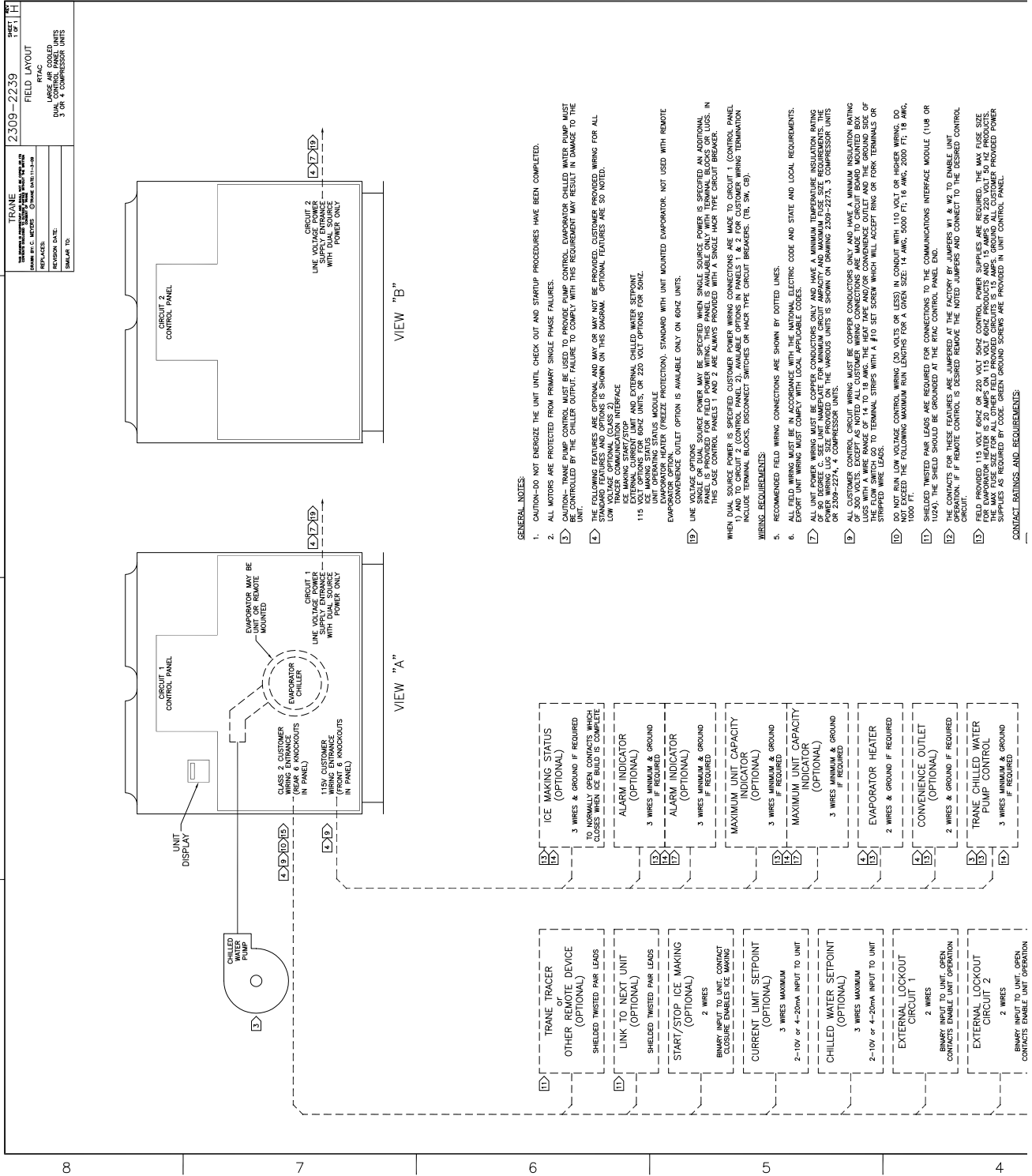

- GENERAL NOTES:**
- CAUTION-DO NOT ENERGIZE THE UNIT UNTIL CHECK OUT AND STARTUP PROCEDURES HAVE BEEN COMPLETED.
 - ALL MOTORS ARE PROTECTED FROM PRIMARY SINGLE PHASE FAILURES.
 - CAUTION- TRANE PUMP CONTROL MUST BE USED TO PROVIDE PUMP CONTROL. EVAPORATOR CHILLED WATER PUMP MUST BE CONTROLLED BY THE CHILLER OUTPUT. FAILURE TO COMPLY WITH THIS REQUIREMENT MAY RESULT IN DAMAGE TO THE PUMP.
 - THE FOLLOWING FEATURES ARE OPTIONAL AND MAY OR MAY NOT BE PROVIDED. CUSTOMER PROVIDED WIRING FOR ALL STANDARD FEATURES AND OPTIONS IS SHOWN ON THIS DIAGRAM. OPTIONAL FEATURES ARE SO NOTED.
- ICE MAKING START/STOP
LOW VOLTAGE COMMUNICATIONS INTERFACE
115 VOLT OPTIONS FOR 60HZ UNITS, OR 220 VOLT OPTIONS FOR 50HZ UNITS
- EVAPORATOR HEATER (FREEZE PROTECTION). STANDARD WITH UNIT MOUNTED EVAPORATOR. NOT USED WITH REMOTE CONVENIENCE OUTLET OPTION IS AVAILABLE ONLY ON 60HZ UNITS.
- LINE VOLTAGE OPTIONS
SINGLE OR DUAL SOURCE POWER MAY BE SPECIFIED WHEN SINGLE SOURCE POWER IS SPECIFIED AN ADDITIONAL 115VOLT OR 220VOLT OPTION IS AVAILABLE. THIS CASE CONTROL PANELS 1 AND 2 ARE ALWAYS PROVIDED WITH A SINGLE HOCR TYPE CIRCUIT BREAKER.
- WHEN DUAL SOURCE POWER IS SPECIFIED CUSTOMER POWER WIRING CONNECTIONS ARE MADE TO CIRCUIT 1 (CONTROL PANEL 1) AND TO CIRCUIT 2 (CONTROL PANEL 2). AVAILABLE OPTIONS IN PANELS 1 & 2 FOR CUSTOMER WIRING TERMINATION INCLUDE TERMINAL BLOCKS, DISCONNECT SWITCHES OR HOCR TYPE CIRCUIT BREAKERS (16, 3A, 6S).
- WIRING REQUIREMENTS:**
- RECOMMENDED FIELD WIRING CONNECTIONS ARE SHOWN BY DOTTED LINES.
 - ALL FIELD WIRING MUST BE IN ACCORDANCE WITH THE NATIONAL ELECTRIC CODE AND STATE AND LOCAL REQUIREMENTS. EXPORT UNIT WIRING MUST COMPLY WITH LOCAL APPLICABLE CODES.
 - ALL UNIT POWER WIRING MUST BE COPPER CONDUCTORS ONLY AND HAVE A MINIMUM TEMPERATURE INSULATION RATING OF 90°C (194°F). WIRING SHALL BE PROVIDED BY THE CUSTOMER. WIRING SHALL BE PROVIDED BY THE CUSTOMER. COMPRESSOR UNITS OR 2309-2274, 4 COMPRESSOR UNITS.
 - MAXIMUM UNIT CAPACITY INDICATOR (OPTIONAL)
OF 500 VOLTS. EXCEPT AS NOTED WIRE CONNECTIONS ARE MADE TO CIRCUIT BOARD MOUNTED BOX UNITS WITH A WIRE RANGE OF 14 TO 18 AWG. THE HEAT TAPE AND/OR CONVENIENCE OUTLET AND THE GROUND SIDE OF THE WIRING SHALL BE PROVIDED BY THE CUSTOMER. TERMINAL STRIPS WITH A #10 SET SCREW WHICH WILL ACCEPT RING OR FORK TERMINALS OR STRIPPED WIRE LEADS.
 - DO NOT RUN LOW VOLTAGE CONTROL WIRING (50 VOLTS OR LESS) IN CONDUIT WITH 110 VOLT OR HIGHER WIRING. DO NOT EXCEED THE FOLLOWING MAXIMUM RUN LENGTHS FOR A GIVEN SIZE: 14 AWG, 5000 FT; 16 AWG, 2000 FT; 18 AWG, 1000 FT.
 - SHIELDED TWISTED PAIR LEADS ARE REQUIRED FOR CONNECTIONS TO THE COMMUNICATIONS INTERFACE MODULE (108 OR 109) AND TO THE TRANE TRACER (107) AND TO THE TRANE TRACER (107) AND TO THE TRANE TRACER (107).
 - THE CONDUCTORS FOR THESE FEATURES ARE DEREGULATED BY THE CUSTOMER. THE CUSTOMER SHALL PROVIDE THE WIRING AND WIRING OPERATION. IF REMOTE CONTROL IS DESIRED REMOVE THE NOTED JUMPERS AND CONNECT TO THE DESIRED CONTROL CIRCUIT.
 - FIELD PROVIDED 115 VOLT 60HZ OR 220 VOLT 50HZ CONTROL POWER SUPPLIES ARE REQUIRED. THE MAX FUSE SIZE SHALL BE 15 AMP. THE MAX FUSE SIZE FOR ALL OTHER FIELD PROVIDED CIRCUITS IS 15 AMPS. GROUND ALL CUSTOMER PROVIDED POWER SUPPLIES AS REQUIRED BY CODE. GREEN GROUND SCREWS ARE PROVIDED IN UNIT CONTROL PANEL.
- CONTACT RATINGS AND REQUIREMENTS:**

- 107 TRANE TRACER (OPTIONAL)
2 WIRES
- 108 OTHER REMOTE DEVICE (OPTIONAL)
2 WIRES
- 109 SHIELDED TWISTED PAIR LEADS TO NEXT UNIT (OPTIONAL)
2 WIRES
- 110 SHIELDED TWISTED PAIR LEADS TO NEXT UNIT (OPTIONAL)
2 WIRES
- 111 START/STOP ICE MAKING (OPTIONAL)
2 WIRES
- 112 BINARY INPUT TO UNIT. CONTACT CLOSURE ENABLES ICE MAKING (OPTIONAL)
2 WIRES
- 113 CURRENT LIMIT SETPOINT (OPTIONAL)
3 WIRES MAXIMUM
- 114 2-10V or 4-20mA INPUT TO UNIT (OPTIONAL)
2 WIRES
- 115 CHILLED WATER SETPOINT (OPTIONAL)
3 WIRES MAXIMUM
- 116 2-10V or 4-20mA INPUT TO UNIT (OPTIONAL)
2 WIRES
- 117 EXTERNAL LOCKOUT CIRCUIT 1 (OPTIONAL)
2 WIRES
- 118 BINARY INPUT TO UNIT. OPEN CONTACTS ENABLE UNIT OPERATION (OPTIONAL)
2 WIRES
- 119 EXTERNAL LOCKOUT CIRCUIT 2 (OPTIONAL)
2 WIRES
- 120 BINARY INPUT TO UNIT. OPEN CONTACTS ENABLE UNIT OPERATION (OPTIONAL)
2 WIRES
- 121 ICE MAKING STATUS (OPTIONAL)
3 WIRES & GROUND IF REQUIRED TO NORMALLY OPEN CONTACTS WHICH CLOSES WHEN ICE BUILD IS COMPLETE
- 122 ALARM INDICATOR (OPTIONAL)
3 WIRES MINIMUM & GROUND IF REQUIRED
- 123 ALARM INDICATOR (OPTIONAL)
3 WIRES MINIMUM & GROUND IF REQUIRED
- 124 MAXIMUM UNIT CAPACITY INDICATOR (OPTIONAL)
3 WIRES MINIMUM & GROUND IF REQUIRED
- 125 MAXIMUM UNIT CAPACITY INDICATOR (OPTIONAL)
3 WIRES MINIMUM & GROUND IF REQUIRED
- 126 EVAPORATOR HEATER (OPTIONAL)
2 WIRES & GROUND IF REQUIRED
- 127 CONVENIENCE OUTLET (OPTIONAL)
2 WIRES & GROUND IF REQUIRED
- 128 TRANE CHILLED WATER PUMP CONTROL (OPTIONAL)
3 WIRES MINIMUM & GROUND IF REQUIRED

Dimensions

Note: Mounting location dimensions may vary on units with seismic rating. See unit submittals.

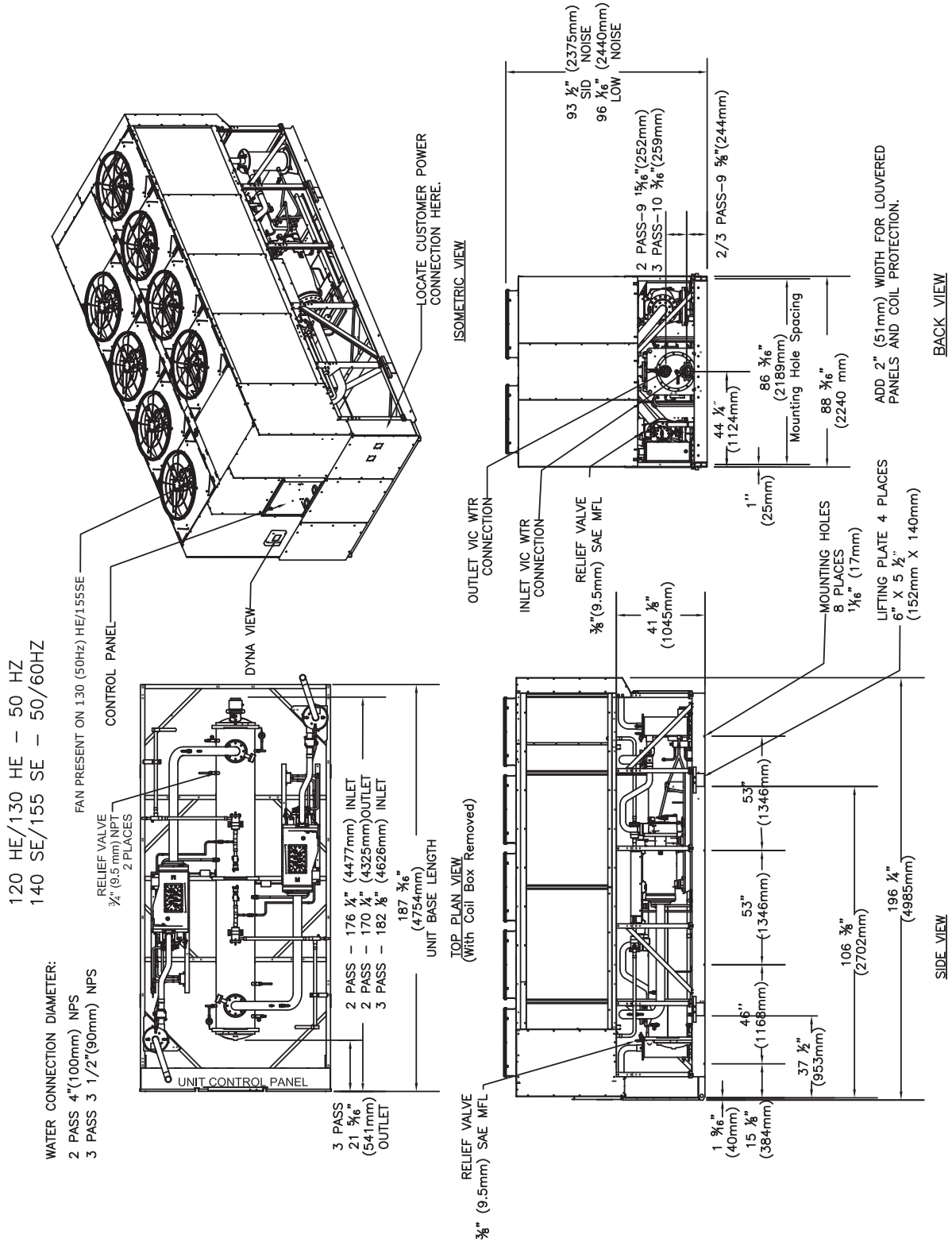

140 HE/170SE - 50 / 60HZ

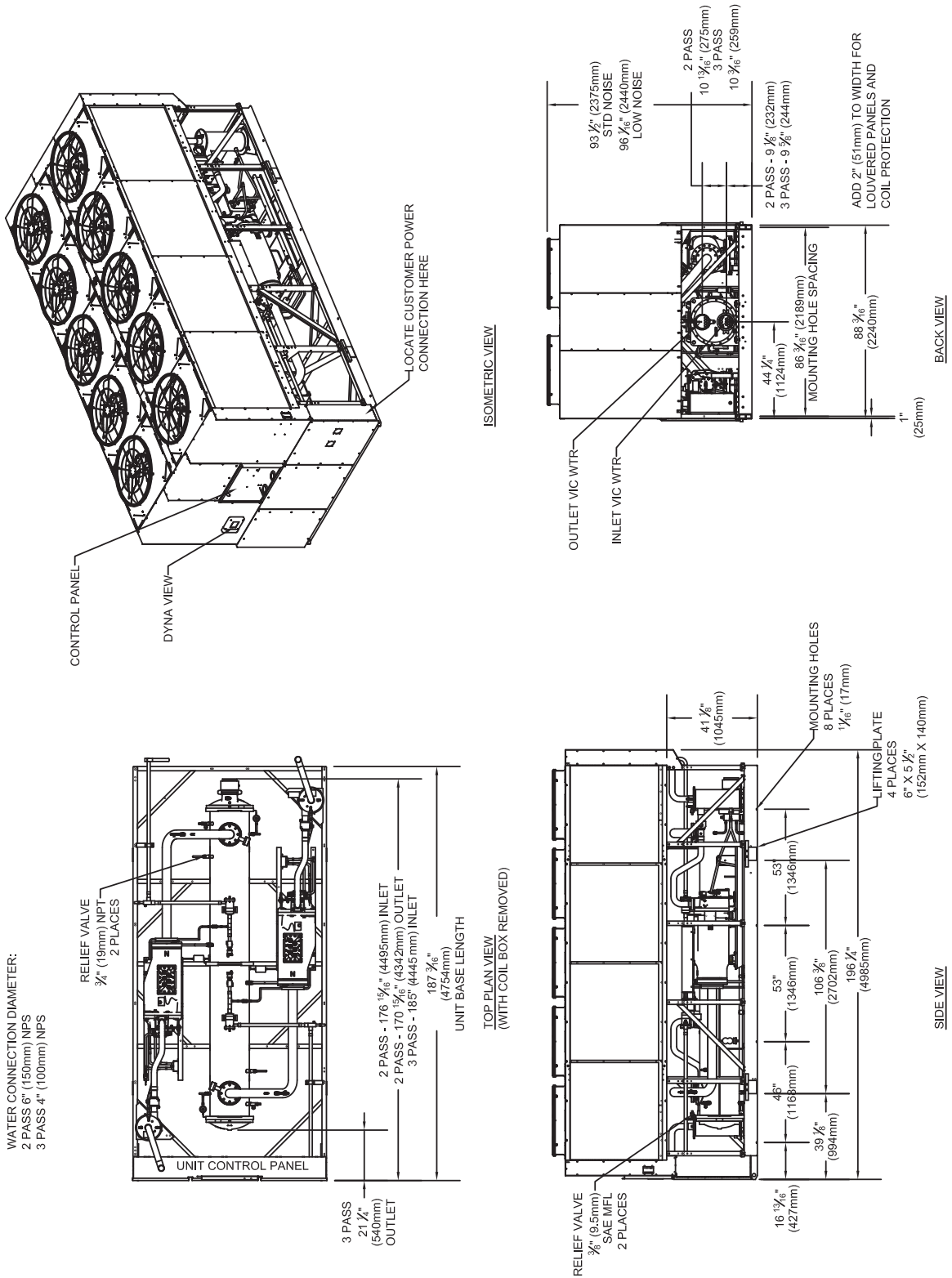

Dimensions

155, 170 HE/185, 200 SE - 50 / 60HZ
140 XE - 60 HZ

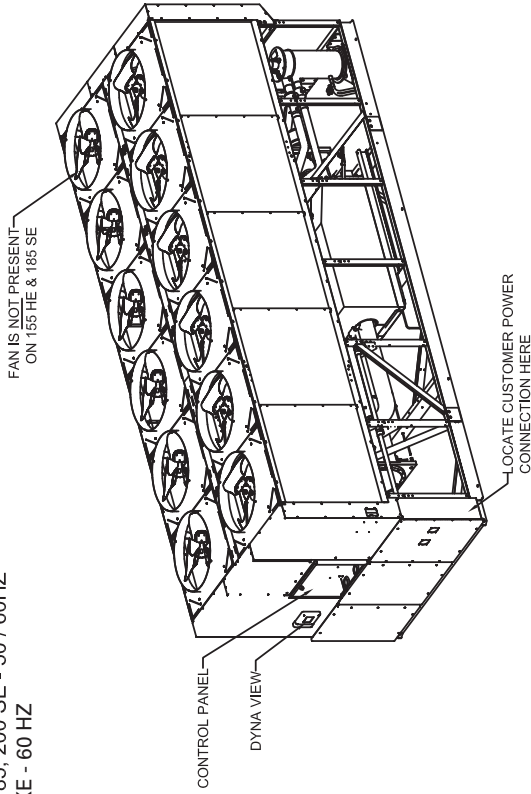

WATER CONNECTION DIAMETER:
2 PASS 6" (150mm) NPS
3 PASS 4" (100mm) NPS

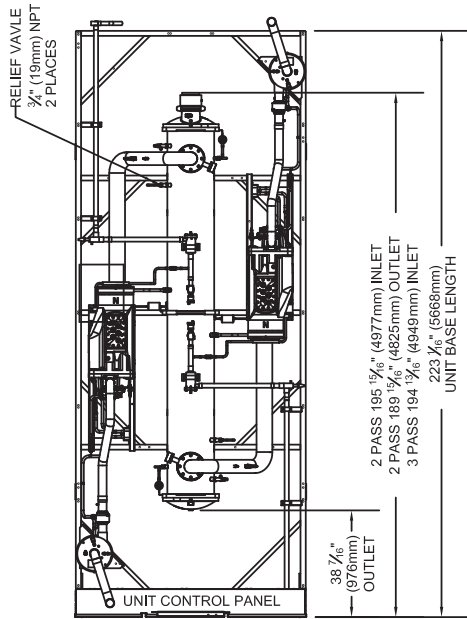

2 PASS 195 15/16" (4977mm) INLET
2 PASS 189 13/16" (4825mm) OUTLET
3 PASS 194 13/16" (4949mm) INLET
223 1/8" (5688mm)
UNIT BASE LENGTH

TOP PLAN VIEW
(WITH COIL BOX REMOVED)

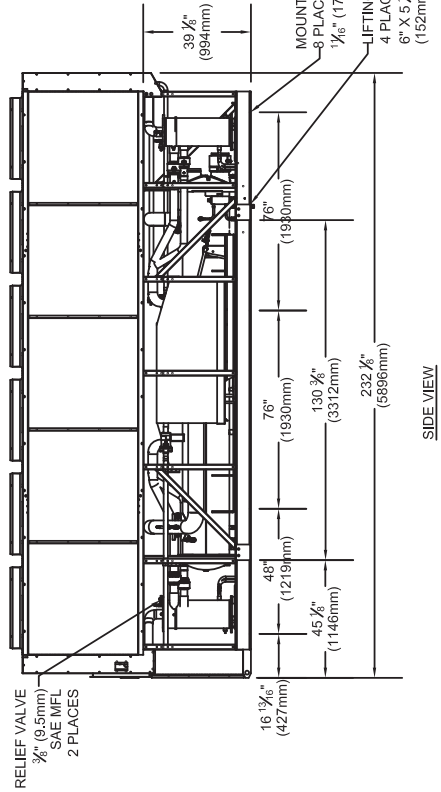

16 1/8" (427mm)
48" (1219mm)
76" (1930mm)
130 3/8" (3312mm)
232 1/8" (5896mm)

SIDE VIEW

ISOMETRIC VIEW

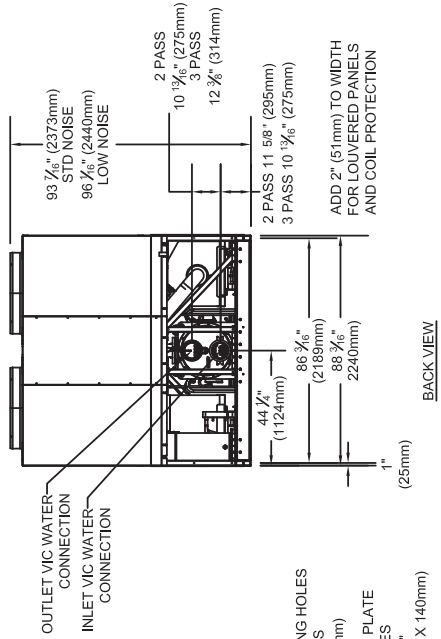

BACK VIEW

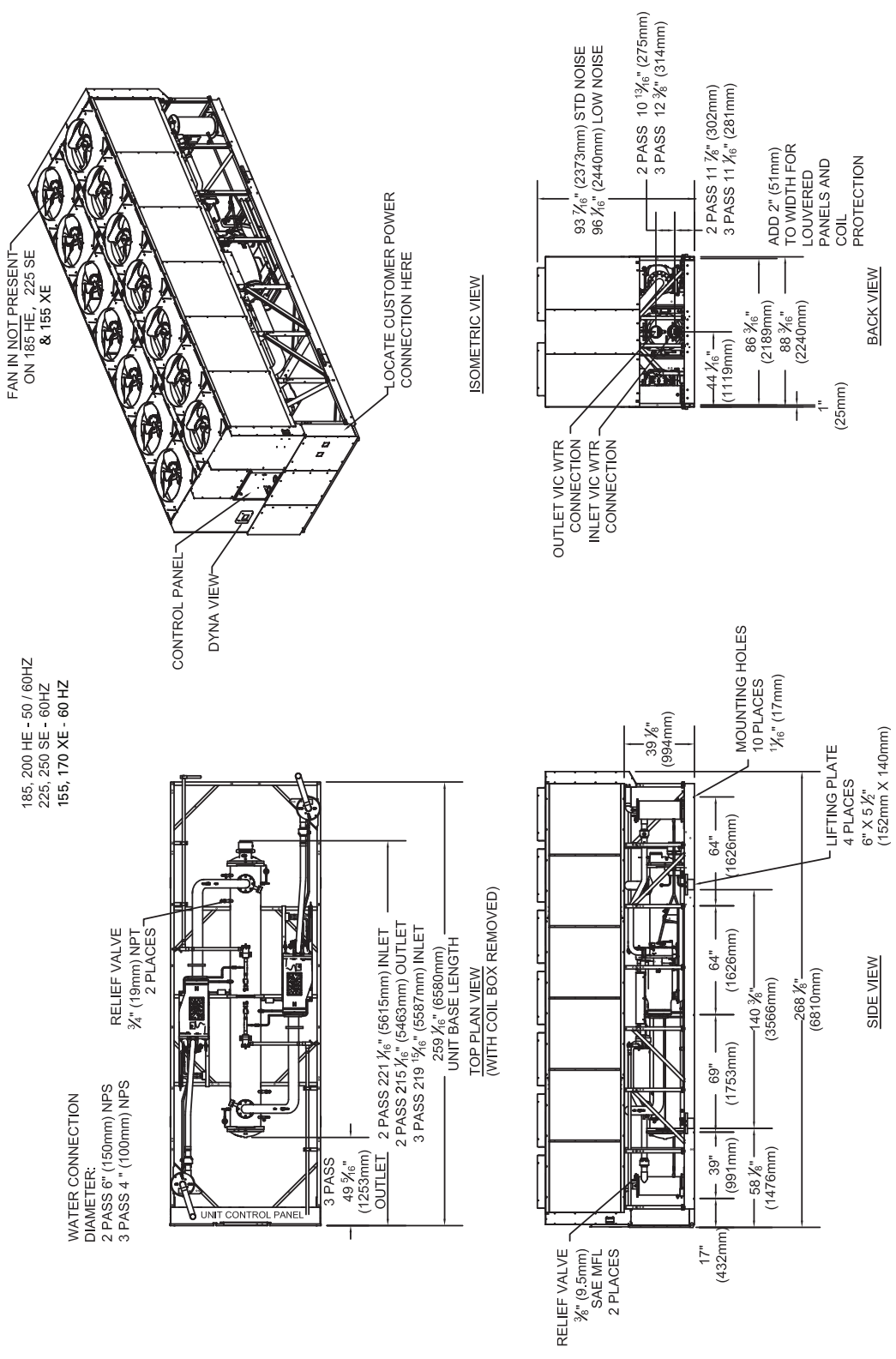

Dimensions

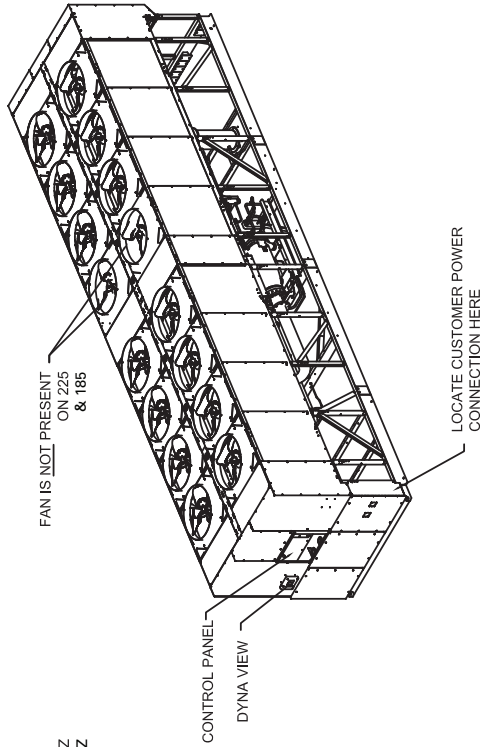

225 & 250 HE - 60 HZ
185 & 200 XE - 60 HZ

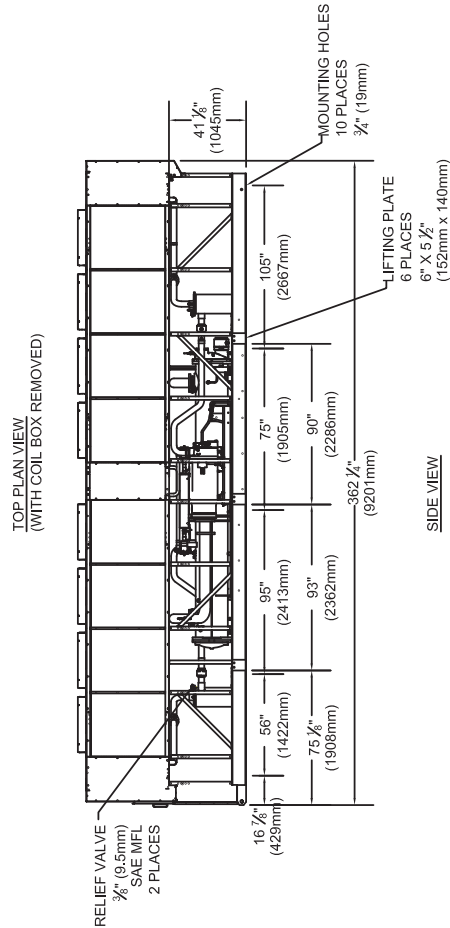
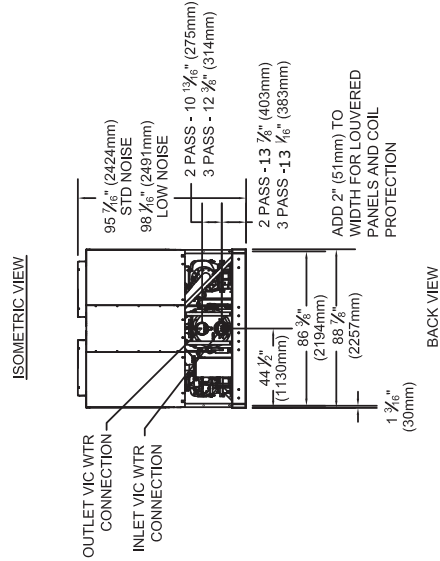
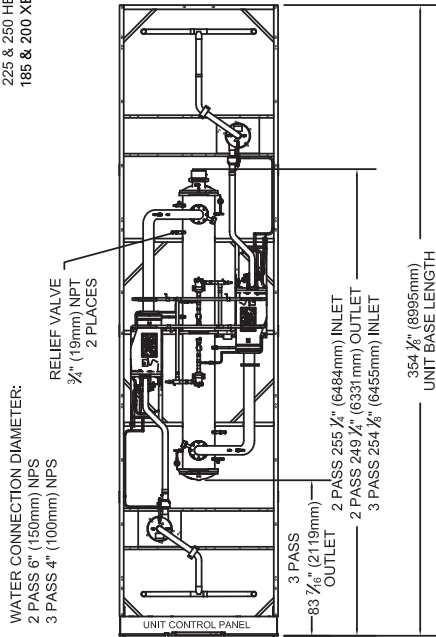

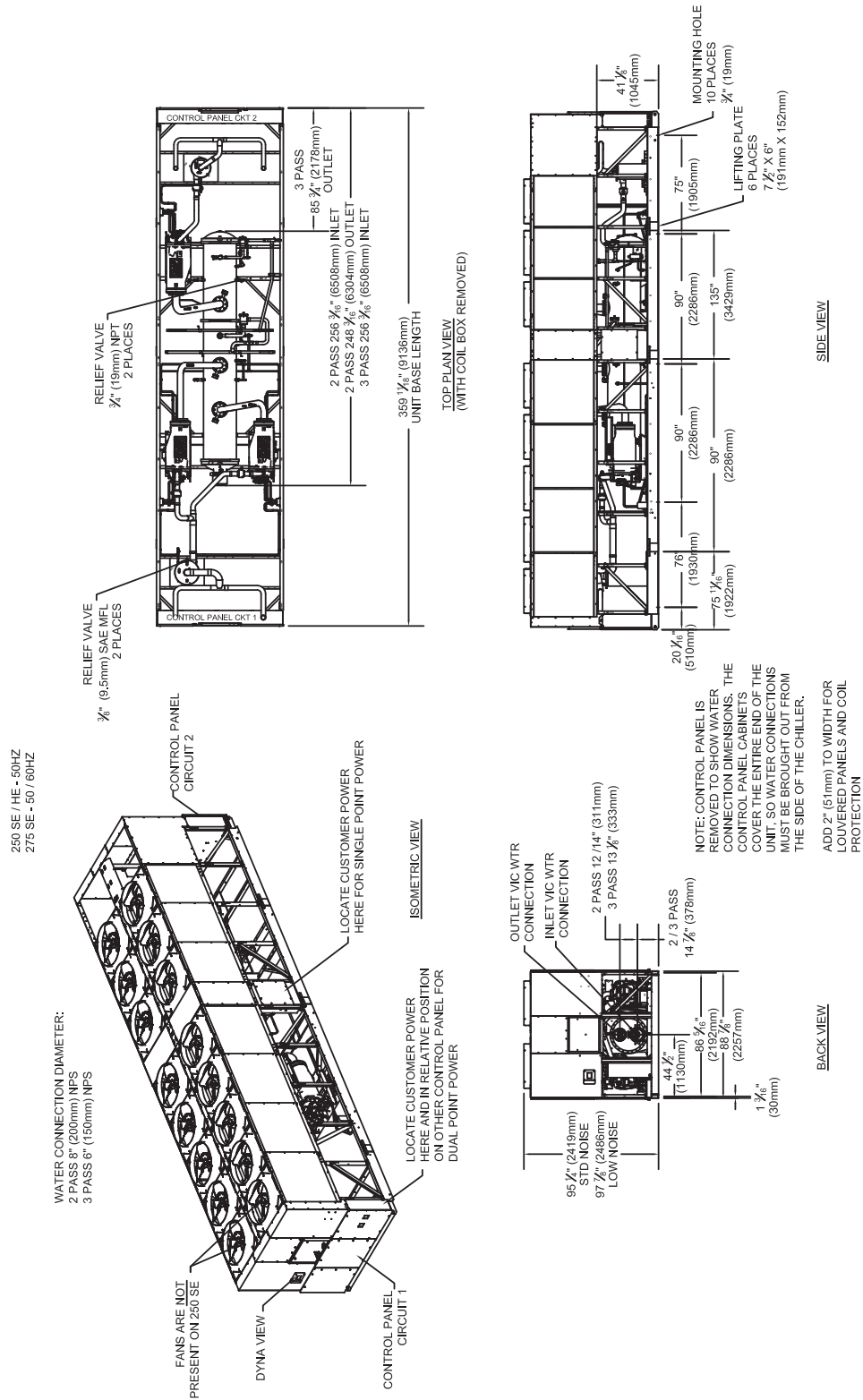

Dimensions

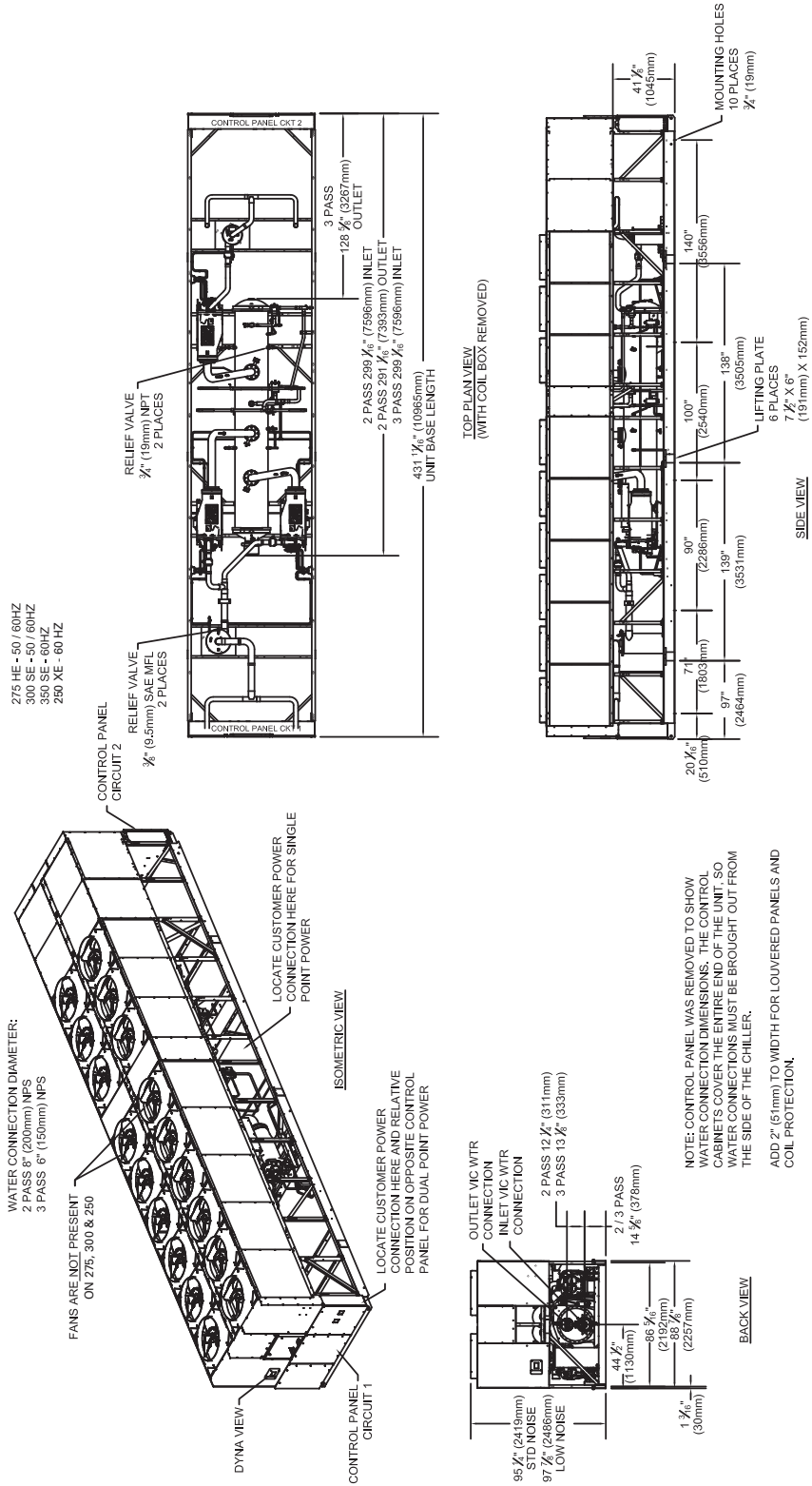

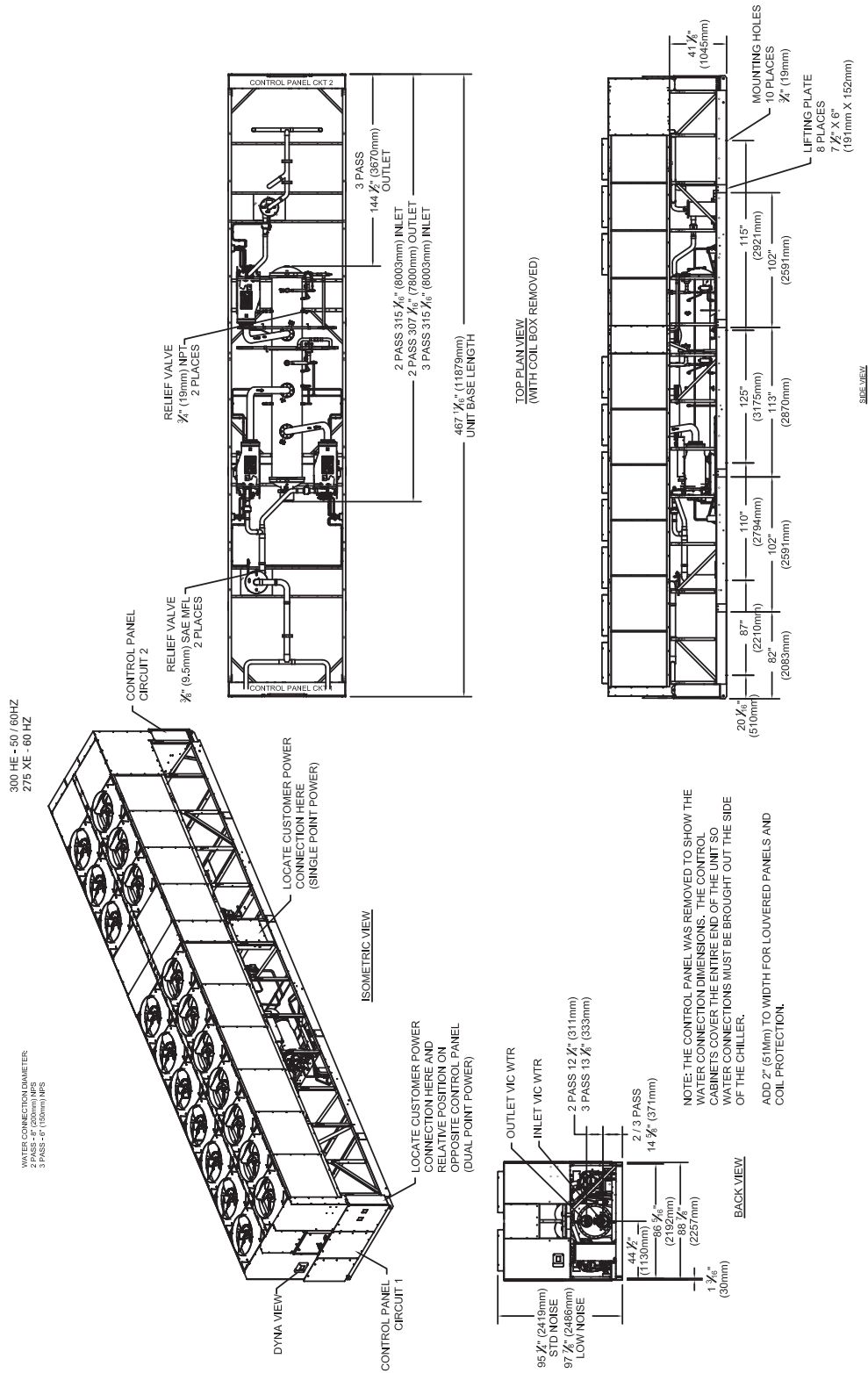

Dimensions

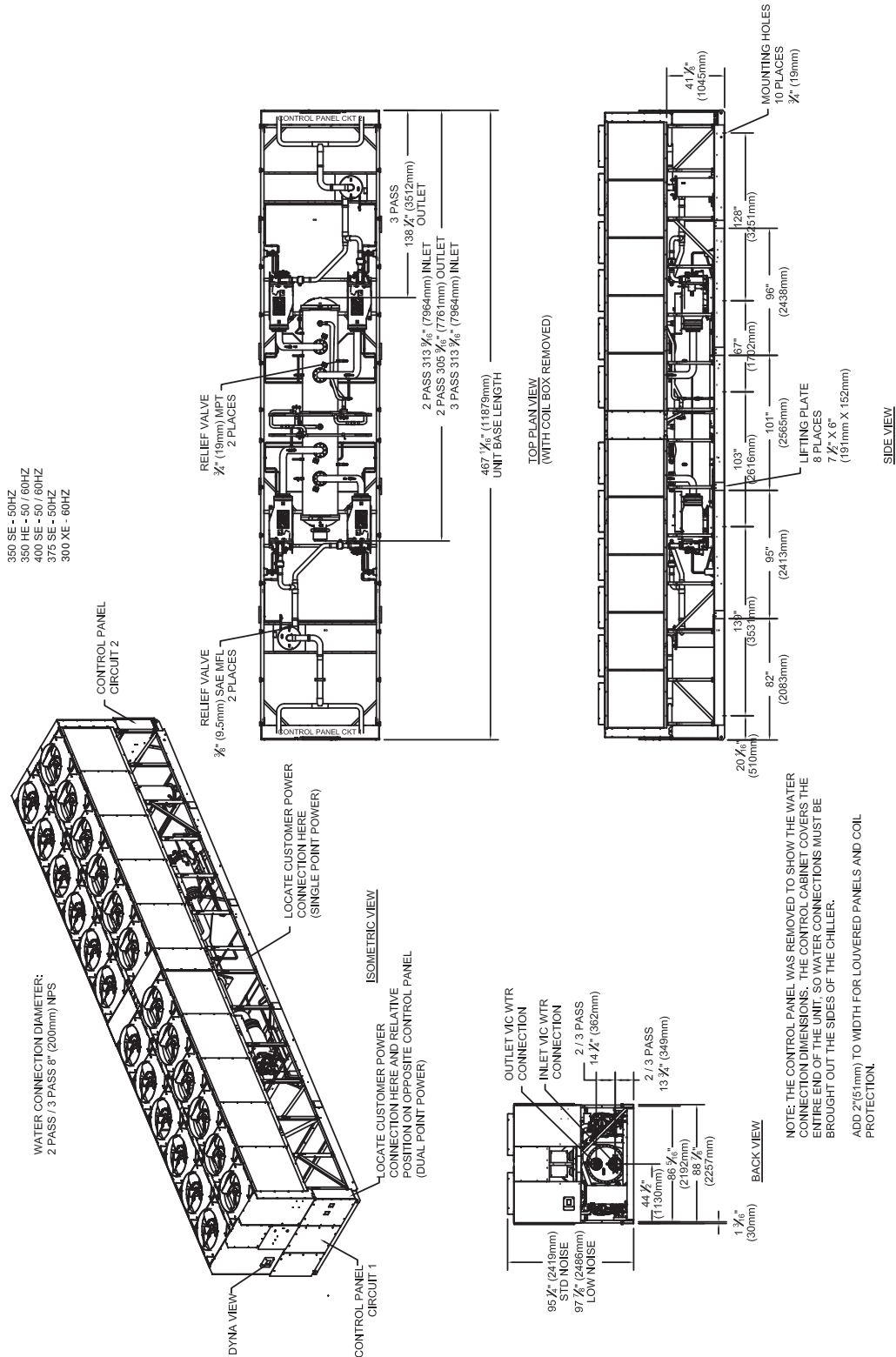

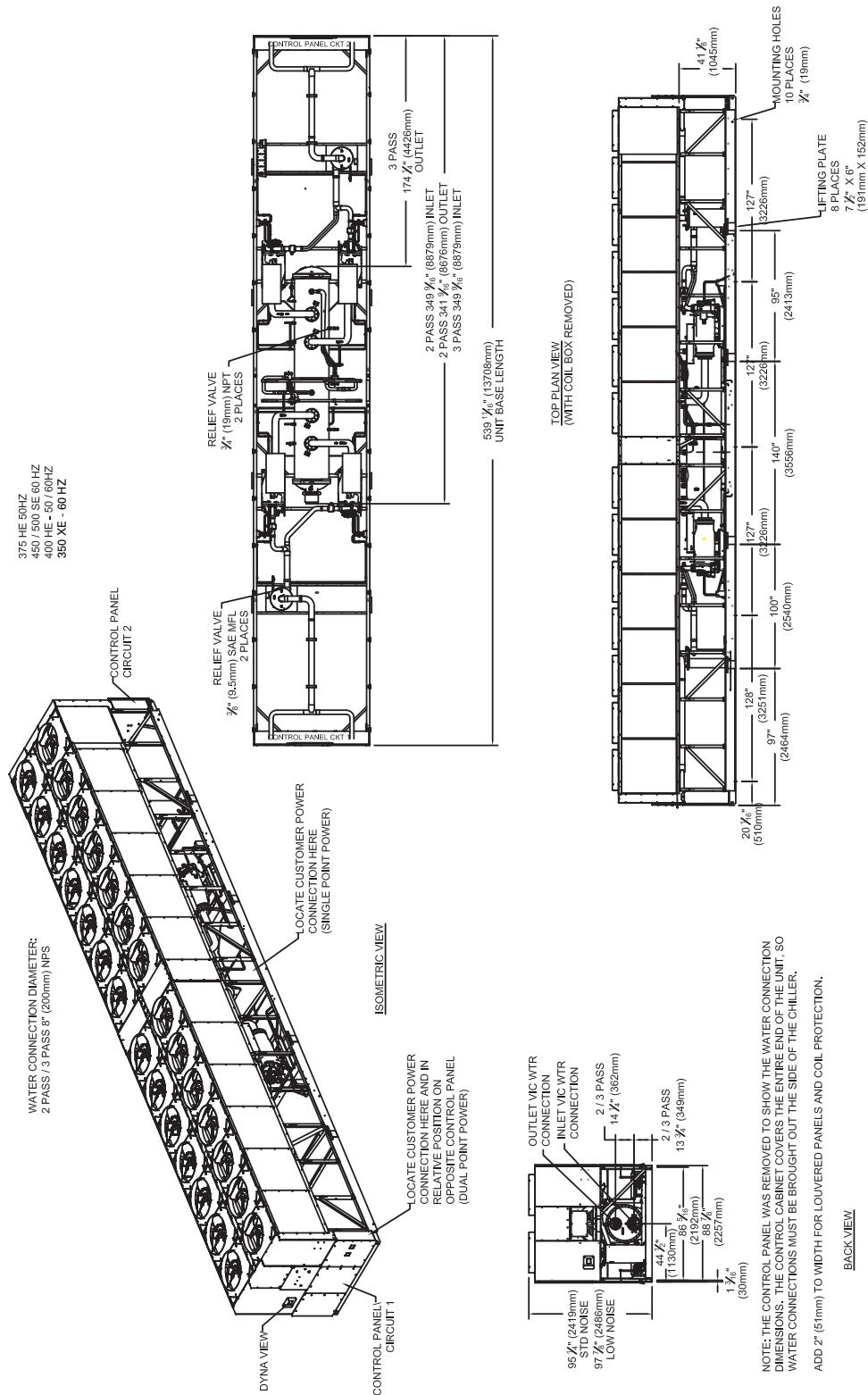



Weights

Non-Seismically Rated Units

Table 14. Weight — packaged units, 60 Hz, aluminum or CompleteCoat™ coils

Unit Size (tons)	Standard Efficiency				High Efficiency				Extra Efficiency			
	Shipping		Operating		Shipping		Operating		Shipping		Operating	
	lb	kg	lb	kg	lb	kg	lb	kg	lb	kg	lb	kg
140	10832	4913	11146	5056	10859	4926	11160	5062	12171	5521	12585	5708
155	10910	4949	11146	5056	12114	5495	12445	5645	13984	6343	14293	6483
170	10877	4934	11218	5088	12171	5521	12585	5708	14454	6556	14721	6677
185	12479	5660	12899	5851	13984	6343	14293	6483	15915	7219	16413	7445
200	12884	5844	13193	5984	14454	6556	14721	6677	16016	7265	16413	7445
225	14635	6638	14966	6788	15915	7219	16413	7445	n/a			
250	14916	6766	15191	6890	16016	7265	16413	7445	20476	9288	21048	9547
275	19025	8630	19685	8929	20393	9250	21048	9547	21667	9828	22160	10052
300	20699	9389	21214	9622	21667	9828	22160	10052	24073	10919	24700	11204
350	21550	9775	22005	9981	24073	10919	24700	11204	27136	12309	27750	12587
400	25409	11525	25854	11727	27136	12309	27750	12587	n/a			
450	26816	12163	27393	12425	n/a				n/a			
500	27136	12309	27912	12661	n/a				n/a			

Notes:

1. Operating weight includes refrigerant and water.
2. Shipping weight includes refrigerant.
3. All weights +/- 3%.

Table 15. Weight — packaged units, 60 Hz, copper coils

Unit Size (tons)	Standard Efficiency				High Efficiency				Extra Efficiency			
	Shipping		Operating		Shipping		Operating		Shipping		Operating	
	lb	kg	lb	kg	lb	kg	lb	kg	lb	kg	lb	kg
140	13407	6081	13734	6230	13426	6090	13734	6230	15590	7071	15998	7257
155	13420	6087	13734	6230	15647	7097	15854	7191	18250	8278	18613	8443
170	13442	6097	13733	6229	15590	7071	15998	7257	18701	8483	18958	8599
185	15870	7198	16253	7372	18250	8278	18613	8443	20794	9432	21290	9657
200	16304	7395	16630	7543	18701	8483	18958	8599	20881	9471	21290	9657
225	18739	8500	18156	8235	20794	9432	21290	9657	n/a			
250	18905	8575	19223	8719	20881	9471	21290	9657	26017	11801	26558	12046
275	23905	10843	24608	11162	26017	11801	26558	12046	27660	12546	28182	12783
300	26039	11811	26580	12056	27660	12546	28182	12783	30848	13992	31431	14257
350	27395	12426	27920	12664	30848	13992	31431	14257	35166	15951	35688	16188
400	32216	14613	32723	14843	35014	15882	35688	16188	n/a			
450	32682	14824	33178	15049	n/a				n/a			
500	35014	15882	35787	16233	n/a				n/a			

Notes:

1. Operating weight includes refrigerant and water.
2. Shipping weight includes refrigerant.
3. All weights +/- 3%.

Seismically Rated Units

Table 16. Weight – seismically rated, packaged units, 60 Hz, aluminum or CompleteCoat™ coils

Unit Size (tons)	Standard Efficiency				High Efficiency				Extra Efficiency			
	Shipping		Operating		Shipping		Operating		Shipping		Operating	
	lb	kg	lb	kg	lb	kg	lb	kg	lb	kg	lb	kg
140	11374	5159	11646	5283	11402	5172	11711	5312	12780	5797	13185	5981
155	11456	5196	11703	5308	12720	5770	13067	5927	14683	6660	15021	6813
170	11421	5180	11779	5343	12780	5797	13214	5994	15177	6884	15433	7000
185	13103	5943	13544	6143	14683	6660	15008	6807	16711	7580	17234	7817
200	13528	6136	13853	6284	15177	6884	15457	7011	16817	7628	17234	7817
225	15367	6970	15714	7128	16711	7580	17234	7817	n/a			
250	15662	7104	15951	7235	16817	7628	17234	7817	21500	9752	22100	10025
275	19976	9061	20669	9375	21413	9713	22100	10025	22750	10319	23268	10554
300	21734	9858	22275	10104	22750	10319	23268	10554	25277	11465	25935	11764
350	22628	10264	23105	10480	25277	11465	25935	11764	28493	12924	29138	13216
400	26679	12102	27147	12313	28493	12924	29138	13216	n/a			
450	28157	12772	28763	13046	n/a				n/a			
500	28493	12924	29308	13294	n/a				n/a			

Notes:

1. Operating weight includes refrigerant and water.
2. Shipping weight includes refrigerant.
3. All weights +/- 3%.



Mechanical Specifications

General

Units are leak and pressure tested at 390 psig high side, 250 psig low side, then evacuated and charged. All air-cooled Series R[®] chillers are factory tested prior to shipment. Packaged units ship with a full operating charge of oil and refrigerant. Unit panels, structural elements and control boxes are constructed of galvanized steel and mounted on a welded structural steel base. Unit panels and control boxes are finished with a baked on powder paint, and the structural base with an air dry paint. All paint meets the requirement for outdoor equipment of the US Navy and other federal government agencies.

Certified AHRI Performance

Trane air-cooled chillers are rated within the scope of the Air-Conditioning, Heating & Refrigeration Institute (AHRI) Certification Program and display the AHRI Certified[®] mark as a visual confirmation of conformance to the certification sections of AHRI Standard 550/590 (I-P) and ANSI/AHRI Standard 551/591 (SI). The applications in this catalog specifically excluded from the AHRI certification program are:

- Custom Units
- Units produced outside of the USA for installations outside the USA
- Evaporatively-cooled chillers
- Units with evaporators that use fluid other than fresh water except units containing freeze protection fluids in the condenser or in the evaporator with a leaving chilled fluid temperature above 32°F [0°C] are certified when rated per the Standard with water.

Evaporator

The evaporator is a tube-in-shell heat exchanger design with internally and externally finned copper tubes roller expanded into the tube sheet. The evaporator is designed, tested and stamped in accordance with ASME for a refrigerant side working pressure of 200 psig. The evaporator is designed for a water side working pressure of 150 psig. Water connections are grooved pipe. Each shell includes a vent, a drain and fittings for temperature control sensors and is insulated with 3/4 inch equal insulation (K=0.28). Evaporator heaters with thermostat are provided to help protect the evaporator from freezing at ambient temperatures down to -20°F (-29°C). Factory installed flow switch is installed on a pipe stub in the evaporator inlet.

Condenser and Fans

Air-cooled condenser coils have aluminum fins mechanically bonded to internally finned seamless copper tubing. The condenser coil has an integral subcooling circuit. Condensers are factory proof and leak tested at 506 psig. Direct drive vertical discharge condenser fans are dynamically balanced. Totally enclosed air over motors completely seal the motor windings to prevent exposure to ambient conditions. Three-phase condenser fan motors with permanently lubricated ball bearings and internal thermal overload protection are provided. Standard units will start and operate between 25 to 115°F (-4 to 46°C) ambient.

Compressor and Lube Oil System

The rotary screw compressor is semi-hermetic, direct drive, 3600 rpm, 60 Hz, with capacity control slide valve, a load/unload valve, rolling element bearings, differential refrigerant pressure oil pump and oil heater. The motor is a suction gas cooled, hermetically sealed, two-pole squirrel cage induction motor. Oil separator and filtration devices are provided separate from the compressor. Check valves in the compressor discharge and lube oil system and a solenoid valve in the lube system are also provided.

Refrigeration Circuits

Each unit has two refrigerant circuits, with one or two rotary screw compressors per circuit. Each refrigerant circuit includes a discharge service valve, liquid line shutoff valve, removable core filter,

liquid line sight glass with moisture indicator, charging port, electronic expansion valve and optional compressor suction service valve. Fully modulating compressors and electronic expansion valves provide variable capacity modulation over the entire operating range.

Unit Controls

All unit controls are housed in an outdoor rated weather tight enclosure with removable plates to allow for customer connection of power wiring and remote interlocks. All controls, including sensors, are factory mounted and tested prior to shipment. Microcomputer controls provide all control functions including startup and shut down, leaving chilled water temperature control, evaporator flow proving, compressor and electronic expansion valve modulation, fan sequencing, anti-recycle logic, automatic lead/lag compressor starting and load limiting. The unit control module, utilizing Adaptive Control™ microprocessor, automatically takes action to avoid unit shutdown due to abnormal operating conditions associated with low refrigerant pressure, high condensing pressure and motor current overload. Should the abnormal operating condition continue until a protective limit is violated, the unit will be shut down. Unit protective functions include loss of chilled water flow, evaporator freezing, loss of refrigerant, low refrigerant pressure, high refrigerant pressure, reverse rotation, compressor starting and running over current, phase loss, phase imbalance, phase reversal, and loss of oil flow. A digital display indicates chilled water setpoint and leaving chilled water temperature as standard. While current limit setpoint, evaporator and condenser refrigerant pressures, and electrical information are an option. Both standard and optional displays can be viewed on the unit without opening any control panel doors. Standard power connections include main three phase power to the compressors, condenser fans and control power transformer and optional connections are available for the 115 volt/60 Hz single phase power for freeze protection on the evaporator heaters.

Starters

Starters are housed in a weather tight enclosure with removable cover plate to allow for customer connection of power wiring. Across-the-line starters are standard on all 380-575/60 volt units. Wye Delta closed transition starters (33 percent of LRA inrush) are optional on 380-575/60 volt units and standard on 200-230/60 Hz volt units. Typically, Trane helical rotary screw compressors are up to full speed in one second when started across-the-line and have equivalent inrush with similar size reciprocating compressor with part wind starters.

Chilled Water Reset

This provides the control logic and factory installed sensors to reset leaving chilled water temperature. The setpoint can be reset based on ambient temperature or return evaporator water temperature.

Flow Control

The factory installed flow switch is provided with the control logic and relays to turn the chilled water flow on and off as the chiller requires for operation and protection. This function is a requirement on the air-cooled Series R® chiller.



Options

Applications Options

High Efficiency/Performance Option

High efficiency option provides an increase in efficiency over standard efficiency by providing oversized heat exchangers for two purposes. One, it allows the unit to be more energy efficient. Two, the unit will have enhanced operation in high ambient conditions.

Extra Efficiency/Performance Option

Extra efficiency option provides an increase in efficiency over the high efficiency unit by providing oversized heat exchangers for two purposes. One, it allows the unit to be more energy efficient. Two, the unit will have enhanced operation in high ambient conditions.

Ice Making

The ice making option provides special control logic and oil coolers to handle low temperature brine applications (less than 40°F [4.4°C] leaving evaporator temperature) for thermal storage applications.

Low Temperature Brine

The low temperature option provides special control logic and oil coolers to handle low temperature brine applications (less than 40°F [4.4°C] leaving evaporator temperature).

Low Ambient Option

The low ambient option provides special control logic, and variable frequency drives on the condenser fan circuits to permit low temperature startup and operation down to 0°F (-18°C).

High Ambient Option

The high ambient option consists of special control logic and oil coolers to permit high ambient (up to 125°F [51°C]) operation. This option offers the best performance when coupled with the high efficiency performance option.

Wide Ambient Option

The wide ambient option combines the features of low and high ambient options for an ambient range of 0 to 125°F (-17.7 to 51°C).

Remote Evaporator

The remote evaporator option is available on the RTAC 140-250 ton units. This option provides a pre-engineered method of installing the evaporator and all related components indoors. Remote evaporator installations allow the water loop to remain indoors to prevent freezing, thus eliminating the addition of glycol to the system and the resulting performance degradation. Please contact your Trane Sales Representative for split system design guidelines found in Engineering Bulletin RLC-PRB014-EN.

Electrical Options

Circuit Breaker

A HACR rated molded case capacity circuit breaker (UL approved) is available. The circuit breaker can also be used to disconnect the chiller from main power with a through the door handle and comes pre-wired from the factory with terminal block power connections. The external operator handle is lockable.

Non-Fused Power Disconnect Switch

The non-fused molded case disconnect switch (UL approved) is used to disconnect the chiller from main power and comes pre-wired from the factory with terminal block power connections. The external operator handle is lockable.

Single/Dual Incoming Power Line Connection

Single or dual points of termination are available for incoming power line connections. Units with 3-4 compressors must order circuit breakers with the single point connection option. These 3-4 compressor units with high amp short circuit rating will have a breaker as the input device in the Single Point box, while units with default short circuit rating will have a terminal block as the input device in the Single Point box regardless of Power Line Connection Type as the Power Line Connection Type only refers to the Main Panel input device. Some restrictions may apply.

Wye-Delta Compressor Start Type

This option provides a reduced inrush starter. Wye-Delta starters are standard on 200-230 volt machines.

Control Options

BACnet® Communications Interface

Allows the user to easily interface with BACnet® via a single twisted pair wiring to a factory installed and tested communication board.

LonTalk® (LCI-C) Communications Interface

Provides the LONMARK® chiller profile inputs/outputs for use with a generic building automation system.

Remote Input Options

Permits remote chilled liquid setpoint, remote current limit setpoint, or both by accepting a 4-20 mA or 2-10 Vdc analog signal.

Remote Output Options

Permits alarm relay outputs, ice making outputs, or both.

Tracer Summit Communication Interface

Permits bi-directional communication to the Tracer® Summit system.

Other Options

Architectural Louvered Panels

Louvered panels cover the complete condensing coil and service area beneath the condenser.

Coil Protection

Louvered panels protect the condenser coils only.

Compressor Sound Enhancement

Factory installed weatherproof compressor enclosure to reduce compressor sound levels.

Condenser Corrosion Protection

Copper fins and CompleteCoat™ are available on all size units for corrosion protection. Job site conditions should be matched with the appropriate condenser fin materials to inhibit coil corrosion and ensure extended equipment life. The CompleteCoat™ option provides fully assembled coils with a flexible dip and bake epoxy coating.

Convenience Outlet

Provides a 15 amp, 115 volt (60 Hz) convenience outlet on the unit.

Flange Kit

Provides a raised face flange kit that converts the grooved pipe evaporator water connections to flange connectors.

Insulation for High Humidity

The evaporator is covered with factory-installed 1.25 inch (31.8 mm) Armaflex II or equal (k=0.28) insulation. Foam insulation is used on the suction line.

Low Noise Fans

Complete fan assembly combining ultra quiet nine blade fans and TEAO fan motors to provide sound reductions with no performance degradation to the unit. The fan blades are heavy-duty molded plastic with wavy edges to reduce airflow turbulence.

Isolators - Neoprene

Isolators provide isolation between chiller and structure to help eliminate vibration transmission. Neoprene isolators are more effective and recommended over spring isolators.

Elastomeric Isolation Pads - Seismically Rated

Elastomeric isolation pads are designed and tested to control the motion of the chiller during a seismic event.

Isolators - Seismically Rated

Spring isolators are designed and tested to control the motion of the chiller during a seismic event.

Seismically Rated Unit - IBC & OSHPD

Unit is built and certified for seismic applications in accordance with OSHPD and the following International Building Code (IBC) releases: 2000, 2003, 2006 and 2009.

Performance Tests

Performance and witness tests are available, based on requested operating points, to certify chiller performance in accordance with AHRI Standard 550/590.

Rapid Restart™ Test

After completion of a standard full load witness test, power to the chiller will be cut and then reapplied to demonstrate the chiller's rapid restart capabilities for disaster relief.

Tarp

The unit will be covered at the factory with a PVC coated polyester tarp that is tied to the chiller base to help protect the chiller from debris during shipment especially in the winter months and on shipping vessels. This option may also be helpful if the chiller will be stored at the jobsite before use.



The AHRI Certified mark indicates Trane U.S. Inc. participation in the AHRI Certification program. For verification of individual certified products, go to ahridirectory.org.

Trane - by Trane Technologies (NYSE: TT), a global climate innovator - creates comfortable, energy efficient indoor environments for commercial and residential applications. For more information, please visit trane.com or tranetechnologies.com.

Trane has a policy of continuous product and product data improvement and reserves the right to change design and specifications without notice. We are committed to using environmentally conscious print practices.